

FIRE DETECTION 2021 SYSTEMS CATALOGUE



www.olympia-electronics.com



for a safer world!



FACT
Smoke alarms
decrease the risk
of dying in a home fire
by 55%.

source: NFPA's "Smoke Alarms in US Home Fires"

**BATTERY OPERATED SMOKE DETECTOR
(LITHIUM OR ALKALINE)**



www.olympia-electronics.com



est. 1979
**olympiaTM
electronics**
SAFETY & SECURITY SYSTEMS

for a safer world!



ANALOGUE ADDRESSABLE FIRE DETECTION SYSTEM

EVPU® CE

The BSR-100X series of analogue addressable fire alarm panels consists of 3 models (1, 2 and 4 loop connections), named BSR 1001, BSR -1002 and BSR 1004 respectively, all sharing the same control interface, functionality and indications.

The accompanying software application for Windows PC, BSR-100X provides utilities for calculating installation parameters, configuring the control panel and keeping an event log record

All BSR 100X models include 4 outputs for conventional sirens, an alarm relay, a fault relay and a programmable auxiliary relay. Two 12V lead acid (Pb) batteries are required in each control panel. The supported battery capacity is 7Ah, 9Ah, 12Ah or 15Ah, which must be calculated in accordance with the size of the installation (number of devices) and the required emergency duration (during mains interruption).

The available loop connections are: 1 for BSR -1001, 2 for BSR - 1002 and 4 for BSR -1004. Each loop output connection can support up to 150 addressable units (smoke and heat detectors, addressable sirens, manual fire call points, etc) .

All features and indications are in accordance with European standards EN 54 2 and EN 54 4. The BSR 100X series analogue addressable fire alarm panels is ideal for medium to large scale facilities such as department stores, hotels and factories because of the ability to have up to 4 panels networking and up to 8 repeaters networking.

The BSR-1000 repeater provides to the user the ability to perform basic system functions and an overview of the current state and events of the panel network via the built-in keypad and illuminated graphics display.





Technical Characteristics

	BSR-1001 Addressable fire detection panel 1 loop / 128 zones	BSR-1002 Addressable fire detection panel 2 loops / 128 zones	BSR-1004 Addressable fire detection panel 4 loops / 128 zones	BSR-1000 Repeater panel
Mains power input	220-240V AC/50-60HZ			
Consumption	130 VA max			
Autonomy	up to 72 hours (without loads at 24VM and 24VP outputs)			
Conventional sounder / siren circuits	4 x 24VDC (\pm 3VDC) / 300mA max short / open circuit monitored 10k Ω termination resistor			
24VP Output	24VDC (\pm 3VDC) permanent output / 300mA max short-circuit monitored			
24VM Output	24VDC (\pm 3VDC) resettable output / 300mA max short-circuit monitored			
Relay Output	3 relay contacts (30VDC/5A)			
Total Load	The total current of the panel (loops, siren circuits, outputs 24P, 24M) must not exceed 2A			
Battery Specifications				
Battery Type	2 lead batteries sealed 12V / 7-15Ah			
Battery cut-off voltage	20,5V			
Maximum battery current discharge	2A max			
Battery resistance (ESR)	1 Ω max(higher values will lead to battery resistance fault)			
Structural characteristics				
Cover protection	IP 30			
Construction materials	ABS/PC, electrostatically painted steel			
Dimensions (LxWxH)	355 x 115 x 345 mm			
Weight (without batteries)	4.08Kgr	4.21Kgr	4.33Kgr	4.08Kgr

CODE	TYPE	DESCRIPTION	
921100102	BSR-1001	Analogue Addressable fire alarm panel with 1 loop (Olympia A Protocol)	4080 gr.
921100200	BSR-1002	Analogue Addressable fire alarm panel with 2 loops (Olympia A Protocol)	4210 gr.
921100400	BSR-1004	Analogue Addressable fire alarm panel with 4 loops (Olympia A Protocol)	4330 gr.
921100000	BSR-1000	Repeater for BSR-100x series panels	4060 gr.

ADDRESSABLE FIRE DETECTION PERIPHERAL DEVICES FOR PANELS BSR-1001/1002/1004

CODE	TYPE	DESCRIPTION
921100402	BSR-1004/MODBUS	Additional board to support bsr-100x panels status monitoring via MODBUS ASCII protocol
927200002	A-200	Thermal printer for the addressable panel BSR-100x (includes BSR-1004/Printer)
927200003	A-200/ETHERNET	Thermal printer for the BSR-100x addressable panel (includes BSR-100x/Ethernet-printer)
923853000	GR-8530	Network ethernet adaptor
921100407	BSR-100x/ETHERNET-PRINTER	Ethernet network card with capability of event printing for BSR-100x series panels
921100408	BSR-100X/ETHERNET-MODBUS	Ethernet network card with capability of status monitoring via MODBUS with ASCII protocol for BSR-100x series panels
923650002	OLYMPIA GATEWAY PC-1000	Safety system networked panel remote monitoring device Configuration PC software for fire alarm installation

GRAPHICAL ENVIRONMENT SOFTWARE FOR FIRE DETECTION SYSTEM MANAGEMENT

CODE	TYPE	DESCRIPTION
921110100	CMI-1101	Visual software monitor BSR-100X

BATTERIES

CODE	TYPE	DESCRIPTION
603001270	A-986	12V / 7Ah SF GUARD 12-7.0 Sealed lead acid battery
603001290	A-961	12V / 9Ah Lead acid battery
603101212	A-940	12V / 12Ah Lead acid battery
603101215	A-1214	12V / 15Ah Lead acid battery

DEVICE FOR CONNECTION WITH PC

CODE	TYPE	DESCRIPTION
921485100	BMS-485	Device for connection BSR-100x panel with PC



BSR-1004 MODBUS



BSR-100x/ETHERNET-PRINTER



A-200
A-200/ETHERNET



GR-8530

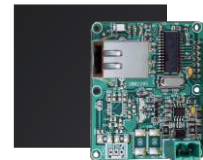

BSR-100x/ETHERNET-MODBUS

Dimensions

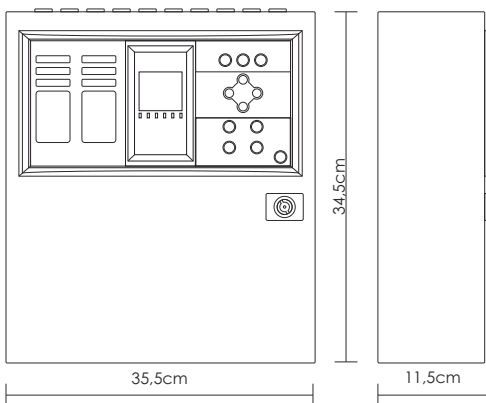

BMS-485





OLYMPIA GATEWAY



ADDRESSABLE MANUAL CALL POINT

EVPU

CODE	TYPE	DESCRIPTION	 VOLTAGE	STANDBY/ALARM CONSUMPTION	
921513600	BSR-5136	Addressable manual call point with integrated isolator (Olympia A Protocol)	IP20 11-30V DC	90µA / 2,5mA	185 gr.

Dimensions

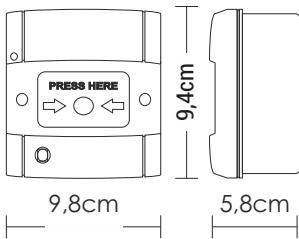

WATERPROOFING CASE

CODE	TYPE	DESCRIPTION	 IP65	
927535000	BOX-535	Waterproofing case for fire alarm call point (fire alarm call point is not included)	IP65	280 gr.

Dimensions

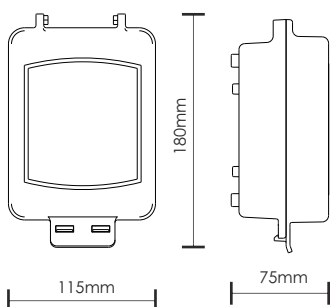

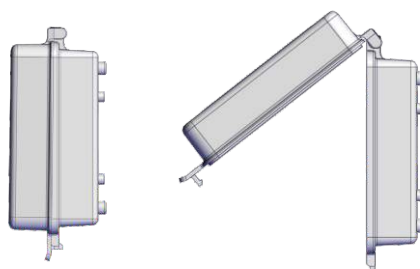

Side view





ADDRESSABLE SIRENS

EVPU



CODE	TYPE	DESCRIPTION	 IP65	MAXIMUM SOUND LEVEL IN 1 METER	VOLTAGE	STANDBY//ALARM CONSUMPTION	 kg
921513201	BSR-5132/WP	Waterproof addressable siren with beacon and integrated isolator	IP65	101dB, Dip switch for siren and beacon selection	11-30V DC	90µA / 11,2-52,4mA	185 gr.
921513000	BSR-5130/WP	Waterproof addressable sounder with integrated isolator	IP65	101dB, Dip switch for siren selection	11-30V DC	90µA / 7.4-35.9mA	313 gr.

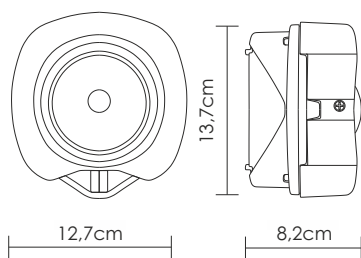

Dimensions







ADDRESSABLE DETECTORS **EVPU**

CODE	TYPE	DESCRIPTION		CLASS	VOLTAGE	STANDBY/ALARM CURRENT	
921615500	BSR-6155	Addressable optical smoke detector with integrated isolator (Olympia A Protocol)	IP42	-	11-30V DC	195µA/2,5mA	160 gr.
921615700	BSR-6157	Addressable optical smoke and rate-of-rise heat detector with integrated isolator (Olympia A Protocol)	IP42	A1R/A1S	11-30V DC	195µA/2,5mA	160 gr.
921616000	BSR-6160	Addressable rate-of-rise heat detector with integrated isolator (Olympia A Protocol)	IP42	A1R/A1S/CS adjustable	11-30V DC	90µA/2,5mA	145 gr.

DETECTORS WITHOUT BASE				CLASS	VOLTAGE	STANDBY/ALARM CURRENT	
CODE	TYPE	DESCRIPTION					
921615501	BSR-6155/WB	Addressable optical smoke detector with integrated isolator (Olympia A Protocol) without base	IP42	-	11-30V DC	195µA/2,5mA	160 gr.
921615703	BSR-6157/WB	Addressable optical smoke and rate-of-rise heat detector with integrated isolator (Olympia A Protocol) without base	IP42	A1R/A1S	11-30V DC	195µA/2,5mA	160 gr.
921616003	BSR-6160/WB	Addressable rate-of-rise heat detector with integrated isolator (Olympia A Protocol) without base	IP42	A1R/A1S/CS adjustable	11-30V DC	90µA/2,5mA	145 gr.

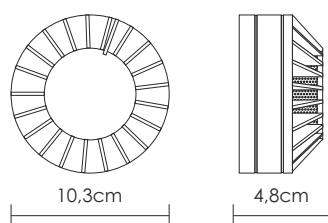
Dimensions



ACCESSORIES				VOLTAGE	STANDBY/ALARM CURRENT	
CODE	TYPE	DESCRIPTION				
921196000	BASE-196/N	Waterproofing box for fire alarm sensor base with cable glands	IP20			160 gr.
921612400	BASE-6124/SB	Base for addressable detector with siren and beacon	IP20	11-30V DC	- /5mA	145 gr.
808165501	BS-6155	Integrated base for the detectors	IP20			50 gr.



BASE-196/N



BASE-6124/SB





BS-6155



ADDRESSABLE TWIN INPUT/OUTPUT UNIT

EVPU

CODE	TYPE	DESCRIPTION	 VOLTAGE	STANDBY/ALARM CURRENT	
921812000	BSR-8120	Addressable twin input/output unit with integrated isolator (Olympia A Protocol)	IP20 11-30V DC	200µA/2,5mA	136 gr.

Dimensions

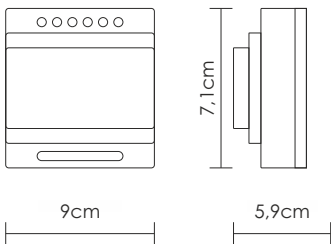

REMOTE DETECTOR LED

CODE	TYPE	DESCRIPTION	VOLTAGE	 STANDBY/ALARM CURRENT	
921572000	BS-572	Remote detector LED (red)	Connected with "R" of the detector	IP20 10mA	50 gr.

 The packaging contains 100pcs.

CONVENTIONAL
FIRE DETECTION
SYSTEMS
& DEVICES



CONVENTIONAL FIRE DETECTION SYSTEM 8-16 zones **EVPU**

The family consists of 3 panels (8, 12 and 16 zones) with identical controls and indications. They have 2 outputs for sirens, an alarm relay, a fault relay and a programmable auxiliary relay.

For their operation, two A-986 (12V/7Ah) batteries are required. Alternatively two A-961 (12V/9Ah) batteries can be used for greater autonomy.

In detail the BS-1638 panel has 8 zones, the BS-1642 has 12 zones and the BS-1646 has 16 zones.

All functions and indications are according to the European norms EN 54-2 and EN 54-4.

The panels offer up to 16 zones and are suitable for large installations such as shopping malls, hotels and factories.

They offer a wide range of settings and characteristics for controlling the installation equipment and sirens which can be easily adjusted using a PC via an Ethernet connection.

BS-1638-42-46 web interface

Panel control web-interface on local network or via olympia gateway for remote control.

LINKS		PANEL	
• INFORMATION PANEL	TIME SETTING	12:16:56	
• INFORMATION ZONES	DATE SETTING	10/12/14	
• USER MENU	STATUS	NORMAL	
• TECHNICIAN MENU	ALARM	0	
• ALL EVENTS	FAULT	0	
• INFORMATION NETWORK	DISABLED	0	
	IN TEST	0	
	NUMBER OF ZONES	8	
	PANEL SOFT VERSION	BS-1638 v 01.02.MU	
	LOCATION	BUILDING	
	TECHNICIAN INFO	OLYMPIA ELECTRONICS	
	TECH TELEPHONE	00302353051200	
	SERIAL NUMBER	1	

Technical Characteristics

	BS-1638 8 zones fire detection panel	BS-1642 12 zones fire detection panel	BS-1646 16 zones fire detection panel
Mains power supply	220-240V AC/50-60HZ		
Consumption	100 VA		
Autonomy	72 hours with two 12V/7Ah batteries		
Alarm circuits	Two 24V circuits that are monitored for open and short - circuit conditions (The maximum current for each circuit is 300mA)		
Output 24P	24VDC (±3VDC) permanent output with a maximum current of 0.3 A. The output is protected by a resettable electronic fuse		
Output 24M	24VDC (±3VDC) output which is interrupted during a reset.		
Output relays	Three relay contacts that can handle up to 30V DC and 5 A maximum. All the output relays must be protected with fuses with the same rating.		
Total power	The total output power (zone circuits, siren circuits, outputs 24P and 24M) must not exceed 1A		
Battery Specifications			
Battery Type	2 lead batteries sealed 12V / 7-15Ah		
Battery cut of voltage	21V		
Maximum current batteries discharge	1A		
Battery maximum internal resistance Rimax	10hm		
Structural characteristics			
Cover protection	IP 30		
Construction materials	ABS – PC, electrostatically painted steel		
Dimensions (LxWxH)	345 x 106 x 348 mm		
Weight (without batteries)	3740gr	3780gr	3820gr

CODE	TYPE	DESCRIPTION	kg
921163800	BS-1638	8 zone fire detection panel with LCD display	4509 gr.
921164200	BS-1642	12 zone fire detection panel with LCD display	4545 gr.
921164600	BS-1646	16 zone fire detection panel with LCD display	4596 ar.

ACCESSORIES			
CODE	TYPE	DESCRIPTION	
921164001	BS-1640	4 zones expansion card for BS-1638	
921164100	BS-1641	4 zones expansion card for BS-1642	
923853000	GR-8530	Network ethernet adaptor	
921615000	BS-615	Expansion module with 4 relays for panels	
923650002	OLYMPIA GATEWAY	Safety system networked panel remote monitoring device	



BS-1640



BS-1641



GR-8530



OLYMPIA GATEWAY



BS-615



CONVENTIONAL FIRE DETECTION SYSTEM

The family of fire detection panels consist of 3 types (2, 4 and 6 zone) with identical operation and indications. The panels have 2 independent siren outputs, Alarm, Fault Relay and a programmable AUX relay. The required batteries for the panels are two A-920 (12V/2.6Ah). All functions and indications are according to European Norms EN 54-2 and EN 54-4.



FIRE SYSTEM

CODE	TYPE	DESCRIPTION
------	------	-------------

921162001	BS-1620	Fire detection accessories set
-----------	---------	--------------------------------



4366.5 gr.

Contains:

- BS-1632 conventional fire detection control panel.
- A-920 batteries 12V/2.6Ah x2 for the panel.
- BS-655/A x 2 smoke detector.
- BS-536 manual call point.
- BS-531/1 siren with beacon.

Technical Characteristics

	BS-1632 2 zone fire detection panel	BS-1634 4 zone fire detection panel	BS-1636 6 zone fire detection panel
Mains power input	220-240V AC / 50-60Hz		
Consumption	50VA		
Autonomy	72 hours (Maximum connected detectors 72 and no load at output 24VM and 24VP)		
Alarm circuits	Two 24V circuits that are monitored for open and short circuit conditions (maximum current 300mA each). Each output is protected with a self-reseting electronic fuse.		
24P Output	24VDC (±3VDC) permanent output with maximum current output 0.3 A		
24M Output	24VDC (±3VDC) reset interrupted output with maximum current output 0.3 A		
Relay Output	Three relay contacts with each one having 30VDC and maxium 5A		
Total Load	The total output current (zones circuits, siren circuit, outputs 24P, 24M) must not exceed 600mA.		
Battery Specifications			
Battery Type	2 x 12V Lead acid sealed 2.6Ah		
Battery cut-off voltage	21V		
Maximum current batteries discharge	900mA		
Battery maximum internal resistance Rimax	10hm		
Structural characteristics			
Cover protection	IP30		
Construction materials	ABS - polycarbonate		
Dimensions (LxWxH)	325 x 240 x 85 mm		
Weight (without batteries)	1345gr without battery	1350gr without battery	1360gr without battery

CONVENTIONAL FIRE DETECTION PANELS

CODE	TYPE	DESCRIPTION	kg
921163200	BS-1632	2 zone fire detection panel	1514,5 gr.
921163400	BS-1634	4 zone fire detection panel	1518 gr.
921163600	BS-1636	6 zone fire detection panel	1525 gr.

FIRE DETECTION PERIPHERAL DEVICES FOR PANELS BS-16xx

CODE	TYPE	DESCRIPTION	kg
980163200	A-632	Metallic recess wall mounting base for BS-1632, BS-1634, BS-1636	2070 gr.

Dimensions

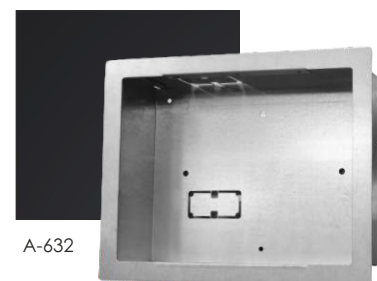
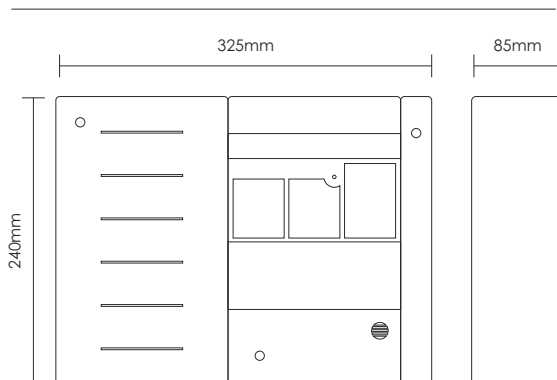



MANUAL CALL POINT



CODE	TYPE	DESCRIPTION	VOLTAGE	kg
921536000	BS-536	Manual call point with TEST-RESET key	10-30V DC	211 gr.

Dimensions

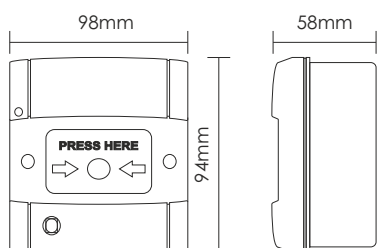

ACCESSORIES				
CODE	TYPE	DESCRIPTION		kg
927533000	A-533	Protective diffuser for BS-536		23,5 gr.
927536000	A-536	Recess wall mounting base		146 gr.



A-536

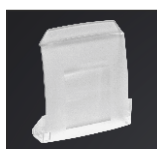

A-533



WATERPROOFING CASE

CODE	TYPE	DESCRIPTION	IP65	kg
927535000	BOX-535	Waterproofing case for fire alarm call point (fire alarm call point is not included)		280 gr.

Dimensions

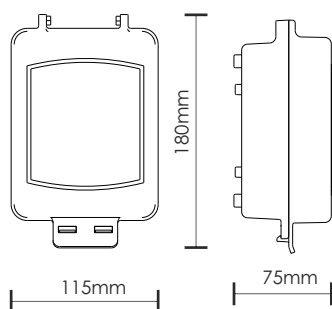

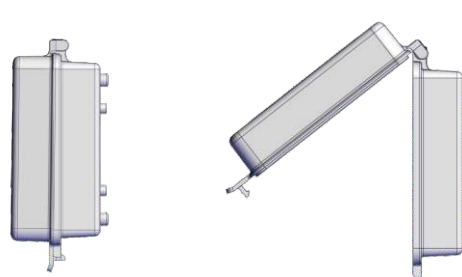

Side view







CONVENTIONAL DETECTORS

*EVPÜ

CODE	TYPE	DESCRIPTION			
921655004	BS-655/A*	Optical smoke detector	IP42	90µA	158 gr.
921657002	BS-657/A	Optical smoke/rate of rise heat detector	IP42	90µA	158 gr.
921660004	BS-660/A*	Rate of rise heat detector	IP42	90µA	143 gr.

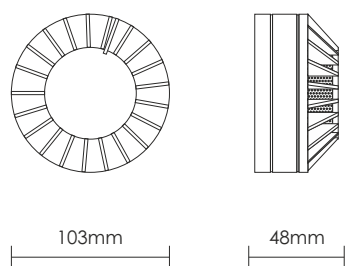
Dimensions



ACCESSORIES			
CODE	TYPE	DESCRIPTION	
927600001	BASE-6024	Base with relay 24V for BS-655, BS-660, BS-657	125,5 gr.
921196000	BASE-196/N	Waterproofing box for fire alarm sensor base with cable glands	160 gr.
808165501	BS-6155	Integrated base for the detectors	50 gr.



BASE-6024



BASE-196/N



BS-6155



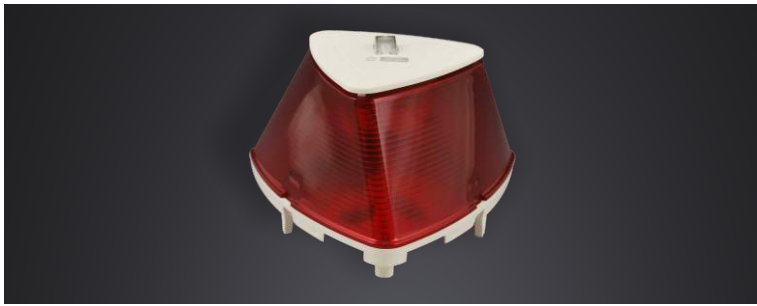

RATE OF RISE HEAT DETECTOR

CODE	TYPE	DESCRIPTION			
921661000	BS-661	Waterproof rate of rise heat detector	IP65	18mA without LED 28mA with LED	160 gr.



SIREN WITH BEACON FOR FIRE ALARM PANELS

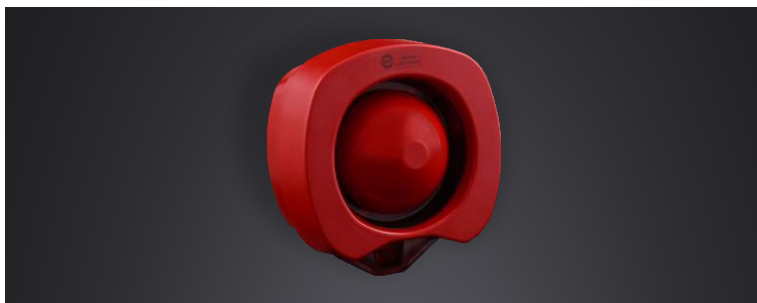
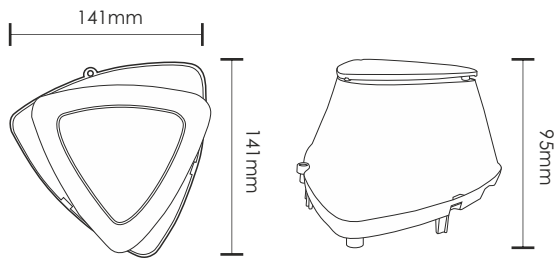

CODE	TYPE	DESCRIPTION	MAXIMUM SOUND LEVEL IN 1 METER	VOLTAGE			
921531007	BS-531/1	Siren with beacon	94dB (sound effect 1)	21-28V DC	IP42C	1,2W	321 gr.

Dimensions



WATERPROOF SOUNDER WITH BEACON

EVPÜ

CODE	TYPE	DESCRIPTION	MAXIMUM SOUND LEVEL IN 1 METER	VOLTAGE			
921532001	BS-532/WP	Waterproof sounder with beacon according to EN 54-3, EN 54-23	103dB	18-30V DC	IP65	12 to 49mA	306 gr.

Dimensions

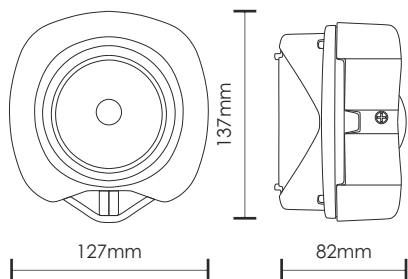





ALARM BELL

CODE	TYPE	DESCRIPTION	VOLTAGE		
921595001	BS-595/A	General purpose bell	24V DC	25mA	905 gr.

 The packaging contains 20pcs.



REMOTE DETECTOR LED

CODE	TYPE	DESCRIPTION	VOLTAGE			
921572000	BS-572	Remote detector LED (red)	Connected with "R" of the detector	IP20	10mA	89 gr.

 The packaging contains 100pcs.

FIRE DETECTION PERIPHERAL DEVICES



BEAM SMOKE DETECTORS



CODE	TYPE	DESCRIPTION	VOLTAGE		SENSIBILITY	
980121100	FIRERAY ONE+1010-000*	50 - 120m Beam smoke detector (with mirror) & reflective long range kit 120m	5mA	IP55	25, 35, 55, 85%, Obscuration	2482 gr.
980125000	FIRERAY ONE*	5 - 50m Beam smoke detector (with mirror)	5mA	IP55	25, 35, 55, 85%, Obscuration	1135,5 gr.

*Trade product



FIRE DETECTION DEVICE FOR SPECIAL USE



CODE	TYPE	DESCRIPTION	VOLTAGE			
980151002	A-510/24*	Floor base for BS-510 (24V)		IP20		500 gr.
980151000	BS-510/24*	Electromagnetic door latch (24V)	24V DC	IP20	80mA	682,5 gr.

*Trade product

The packaging contains 20pcs.



ACCESSORIES FOR TESTING SMOKE & HEAT DETECTORS

CODE	TYPE	DESCRIPTION	
980600110	SOLO TEST-KIT 814-101*	Accessories set for testing smoke & heat detectors which contains: <ul style="list-style-type: none"> ▶ 1 x Accessory for testing smoke dispenser ▶ 1 x Accessory for testing heat dispenser ▶ 1 x Detector removal tool ▶ 1 x telescopic access pole 4.5m (up tp 6m access) ▶ 1 x carrying bag 	6743 gr.



CODE	TYPE	DESCRIPTION
980600116	TESTIFIRE 6001 Smoke/heat Testkit*	Testkit for smoke & heat detectors <ul style="list-style-type: none"> ▶ 1 x Testifire 1000-001 ▶ 1 x Smoke capsule TS3-001 ▶ 2 x Batteries Solo 770-001 ▶ 1 x Charger Solo 727-101 ▶ 1 x Telescopic access pole 4.5m Solo 100-001 (up tp 6m access) ▶ 1 x detector removal tool Solo 200-001 ▶ 1 x Carrying bag Solo 610-001



GENERAL PURPOSE DEVICES

CODE	TYPE	DESCRIPTION	
923024008	GR-24/12V/A	Uninterrupted power supply with 12V DC, 4A DC output	46VA
923024009	GR-24/24V/A	Uninterrupted power supply with 24V DC, 2A DC output	92VA





GENERAL PURPOSE DEVICES

CODE	TYPE	DESCRIPTION		
921537000	BS-537	Cancellation call point	IP54	155 gr.



ALARM INDICATION LUMINARY

CODE	TYPE	DESCRIPTION		VOLTAGE		
921527003	BS-527/WP/V2	Waterproof indication luminary with buzzer	IP65	12-24V DC	45mA 12V-55mA 24V	793 gr.





SLAVED SIGN FOR GENERAL USE

CODE	TYPE	DESCRIPTION		VOLTAGE		
921528000	BS-528	Slaved general purpose illuminated indication sign	IP30	12-24V DC	140mA	1030 gr.





BEACONS

CODE	TYPE	DESCRIPTION		VOLTAGE		
921580000	BS-580	Beacon with XENON lamp	IP20	220-240V AC 50-60Hz	3VA	187 gr.
921576003	BS-576/L	Beacon with LED LED lamp	IP20	12-24V DC	26mA	180 gr.

 The packaging contains 36pcs.



SIREN WITH BEACON

CODE	TYPE	DESCRIPTION		VOLTAGE	
921300200	BS-3002	Siren with beacon & fire extinguishing call point, battery (3xAA)	IP40	4,5V DC	555 gr.
921300100	BS-3001	Siren with beacon, fire ext. call point and backup light	IP40	220-240V AC 50-60Hz	662,5 gr.

 The packaging contains 22pcs.

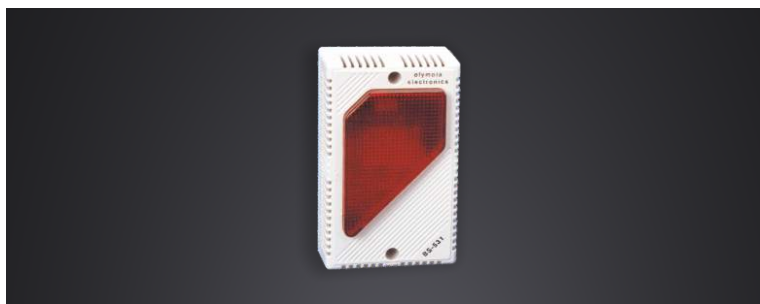

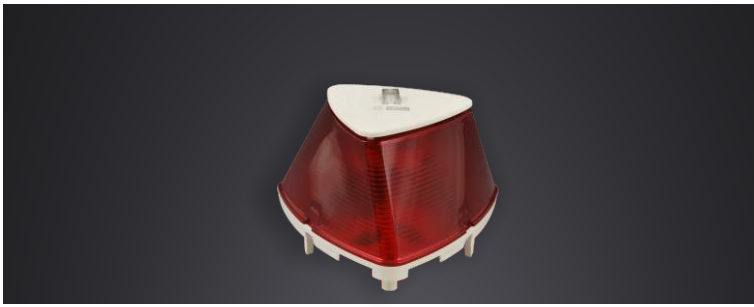

SIREN WITH BEACON

CODE	TYPE	DESCRIPTION		VOLTAGE		
BS-542	921542000	Siren with beacon, 100dB (BS-690, BS-691)	IP20	12V DC	30mA	142,5 gr.



SIREN WITH BEACON

CODE	TYPE	DESCRIPTION		VOLTAGE		
921521006	BS-521/1	Autonomous siren with beacon	IP42	220-240V AC/50-60 Hz	3VA	425 gr.
921521007	BS-521/1/WP	Autonomous siren with beacon IP 65	IP65	220-240V AC/50-60 Hz	3VA	440 gr.

 The packaging contains 15pcs.

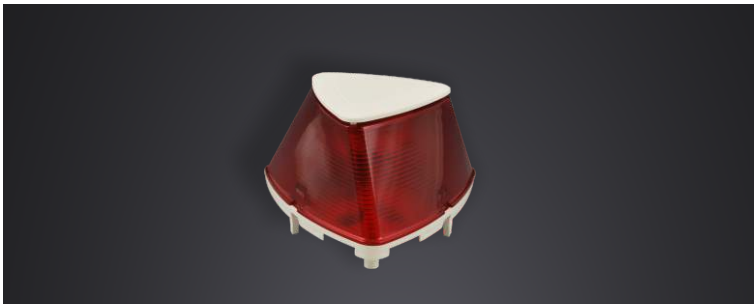



GENERAL PURPOSE SIREN WITH BEACON

CODE	TYPE	DESCRIPTION		VOLTAGE		
921505000	BS-505	Telephone siren, 105dB with intensity regulator	IP42	220-240V AC/50-60 Hz	4,5VA	395 gr.
921505001	BS-505/WP	Telephone siren, waterproof IP65, 105dB with intensity regulator	IP65	220-240V AC/50-60 Hz	4,5VA	410 gr.

 The packaging contains 15pcs.



GENERAL PURPOSE SIREN WITH BEACON

CODE	TYPE	DESCRIPTION		VOLTAGE		
921546000	BS-546	General purpose siren with beacon and intensity regulator, 100db, 230V AC	IP42	220-240V AC	6VA	395 gr.

 The packaging contains 24pcs.



GENERAL PURPOSE CALL POINTS

CODE	TYPE	DESCRIPTION	VOLTAGE		
921536104	BS-536/B	General purpose manual call point - blue color	12-30V DC	IP20	230 gr.
921536106	BS-536/G	General purpose manual call point - green color	12-30V DC	IP20	230 gr.
921536101	BS-536/W	General purpose manual call point - white color	12-30V DC	IP20	230 gr.



WATERPROOFING CASE

CODE	TYPE	DESCRIPTION		
927530000	BOX-530	Waterproofing case for fire detection- extinguishing manual call point (stickers are included - fire alarm call point is not included)	IP65	280 gr.





PERIPHERAL DEVICES

CODE	TYPE	DESCRIPTION	
980148500	A-485 ADAM 45105	Signal amplifier for RS-485	225 gr.
980145410	A-4541 ADAM	Multi-mode Fiber Optic to RS-485 Converter	225 gr.

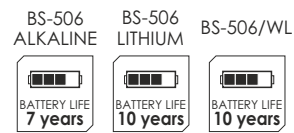

BATTERY OPERATED SMOKE DETECTOR



CODE	TYPE	DESCRIPTION		
921506000	BS-506/ALKALINE	Battery operated smoke detector (2x Alkaline AA (Lr6))	IP20	185 gr.
921506001	BS-506/LITHIUM	Battery operated smoke detector (2x AA Lithium FR6 (L91))	IP20	185 gr.
921506002	BS-506/WL	Wireless interconnect battery operated smoke detector (2x AA Lithium FR6 (L91))	IP20	185 gr.

Technical Characteristics

- Automatic fault diagnosis
- Infrared photoelectric sensing technology
- Moth-proof design
- Dynamical dust compensation
- Hush function
- Alarm memory
- Low battery indication with optional 8 hours suspension
- EN14604:2005 certified.

Dimensions

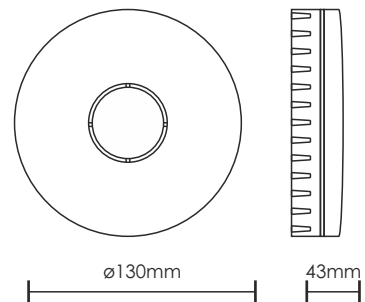

FIRE EXTINGUISHING SYSTEM



FIRE EXTINGUISHING PANEL & ACCESSORIES

The panel BS-627 is suitable for extinguishing installations. They have one extinguish output, two cross zones for fire detector, one zone for a manual call point to start the extinguish, one zone for a manual call point to cancel the extinguish procedure, one fire extinguish output monitored for open and short circuit. The output can operate with actuators or electro valves.

The panel has two independent siren outputs, one contact relay for fault status, two fully programmable relay contacts, terminals to communicate with conventional fire detection panels.

For there operation, one battery A-986 (12V/7Ah) is required. All functions and indications are according to European Norms EN12094-1.

Dimensions

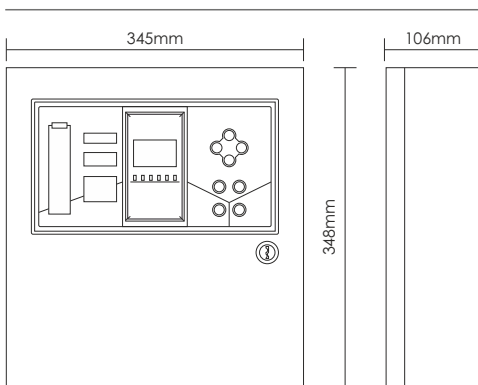

Technical Characteristics

BS-627 4 zone panel with one extinguish output	
Mains power supply	220-240V AC/50-60HZ
Consumption	100 VA
Autonomy	48 hours with one battery 12V-7Ah and 72 hours with two batteries 12V-7Ah
Alarm circuits	Two 24V circuits that are monitored for open and short circuit conditions (The maximum current for each circuit is 300mA)
Output 24VP	26VDC (±3VDC) permanent output with maximum current output 0.3 A The output is protected with a self-reseting electronic fuse.
Output 24VM	26VDC (±3VDC) reset interrupted output with maximum current output 0.3 A The output is protected with a self-reseting electronic fuse.
Fault relay and relays 1 and 2	The relay 1 and 2 contacts have value of 5A 250VAC. The fault relay contacts have value 1A 30VDC.
Extinguish output	Extinguish output for actuators and electro valves (maximum 26VA). The circuit is monitored for open and short circuit conditions
Total load	The total output current (zones circuits, siren circuit, outputs 24VP, 24VM) must not exceed 1A.
Battery Specifications	
Battery Type	One or two 12V Lead acid sealed battery 7Ah maximum
Battery cut of voltage	21V
Maximum current batteries discharge	1A
Battery maximum internal resistance Rimax	10hm
Structural characteristics	
Cover protection	IP 40
Construction materials	Electrostatically painted metal plate and ABS - polycarbonate
Dimensions (LxWxH)	345 x 125 x 348 mm
Weight (without batteries)	3880 gr

CODE	TYPE	DESCRIPTION	kg
921627000	BS-627 *	4 zones fire extinguishing panel, 1 extinguishing command	4530 gr.

* Two batteries A-986 12V/7Ah are required for the 72h of autonomy.
* One battery A-986 12V/7Ah is required for the 48h of autonomy.

ACCESSORIES			
CODE	TYPE	DESCRIPTION	kg
921637000	BS-637	Waterproof driving unit for aerosol fire extinguishing systems	211,5 gr.
921533000	BS-533	Extinguishing call point	212,5 gr.
921534000	BS-534	Extinguishing call point with cancelling key	229,5 gr.
927533000	A-533	Panic button protective cover	26 gr.
927535000	BOX-537	Waterproof case for fire extinguishing manual call point (the call point is not included)	280 gr.



BS-637



BS-533



BS-534

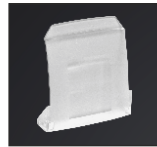

A-533



BOX-537

VOICE ALARM
CONTROL AND
INDICATING
EQUIPMENT



VOICE EVACUATION SYSTEM

The **Compact 500** offers a complete, integrated solution for a Voice Alarm Control and Indicating Equipment (VACIE) system, based on the boxed-amplifier concept.

Each Compact unit is fully self-contained, including the routing necessary to serve up to 6 single zones of 100W RMS power each, with additional active back-up amplifiers. It also offers the additional capability for the amplifiers to be bridgeable, for a total of 3 zones of 200W RMS.

The Class D power amplifiers used in the Compact 500 offer high efficiency (80% rated power) operation at 100V RMS and a full spectrum bandwidth from 50 Hz to 20 kHz, as well as a low Signal to Noise (SNR) ratio, rated at less than 80dB. It is also able to be used as a Public Address (PA) system, as well by offering the capability to play Background Music (BGM) due to its full

spectrum bandwidth of 50 Hz to 20kHz, low input-output latency (less than 10 ms) and advanced DSP features (HP/LP filter, multipoint parametric eq).

The system has a built-in power supply, EN 54-4 certified, rated to operate with voltages of 110-230 V AC, 50/60 Hz and it is compatible with 2x12V Pb batteries of up to 55 Ah, offering large autonomy.

The Compact 500 system is fully networkable, for up to 255 devices in a global network, and it is able to connect to Olympia-Electronics fire detection panels, offering the ability to fully cover large installations. The capability of the system to be utilized as a PA, makes it suitable for projects such as malls, airports and schools, leading to a simplified installation with increased safety for the occupants.

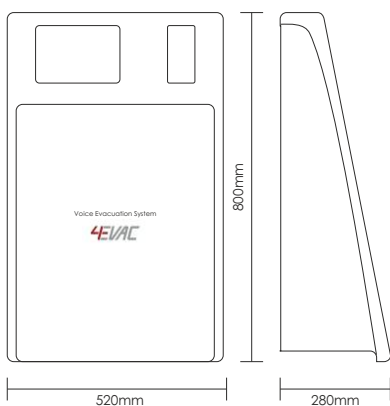

Dimensions



Technical specifications

Number of zones	max. 6 local zones
Total output power	600W (pink-noise)
Power amplifiers	up to 6 x 100W modular Class D (2 channels per module) bridgeable up to 3 x 200W
Standby power amplifiers	2 x 100 W /1 x 200 W Class D dedicated backup amplifiers
Loudspeaker type	V step-down transformer.
Voice messages	
Storage	max. 16 audio files x 1 minute, micro-SD card with content monitoring
Message player	max. 6 simultaneous local message playback
Power supply equipment	Built-in power supply system EN 54-4 certified.
AC supply	110 – 230 V AC, 50/60 Hz
AC current consumption	max. 5.3 A @115 V AC / 2.65A @230 V AC
Inrush current	40A @115 V AC, 20A @230 V AC
Power supply protection	Overload current limiting, over voltage shutdown, over temperature shutdown.
Battery requirements	
Type	Sealed, rechargeable lead-acid battery for stationary use
Capacity, charging time	10-55 AH, <24 h @ 80% capacity
Rated voltage	24 V DC (2 x 12 V)
Battery dimensions	2 batteries, each of max. 230x138x207mm (LxWxH)
Battery weight	max. total 32.6 kg

Inputs	
2 x BGM	2 x independent balanced analog in, line-level mono, 22 kΩ input impedance
6 x EVAC in, 1x SILENCE in, 1x RESET in	monitored logic inputs, 4.7 kΩ +10 kΩ EOL resistor
8 x GPI	unmonitored logic inputs (pull-down, configurable active low/hi).
Outputs	
EVAC out, FAULT out	Potential-free relay output (configurable NO/NC)
8 x GPO	Open collector output (configurable NO/NC)
6 x Loudspeaker out	6 x 100 V / 50 V, 100 W transformer output, 20 kHz AC monitoring with Loopdrive EOL unit.
Audio	
Frequency response	50 Hz – 20 kHz (local BGM) 100 Hz – 12 kHz (message player, network audio compressed)
Input- output latency	< 10 ms (stand-alone system)
Digital audio format	24 kHz sampling, ADPCM compressed
DSP features	HP/LP filter, multi-point parametric EQ delay.
Mechanical	
Dimensions (HxWxD)	80 x 52 x 28 cm
Weight (without batteries)	29 kg (6 channel version)
Housing material	Steel / ABS
IP rating	IP 30
Mounting	Wall mounted box, wall bracket included.

CODE	TYPE	DESCRIPTION		
980050000	C500/3+1	Voice Evacuation system with integrated fireman mic, 6 local zones, 6 100W class D amplifiers, 2 backup 100W class D amplifiers, 16 messages storage	IP30	
980050001	C500-RS422-T	Line adapter C500, Rs422	-	
980050003	4E-EOL	End of line device, 200W line load	IP65	
980050004	4E-FMT	Fireman microphone with 7" touchscreen, wall or tabletop mounted	-	
980050011	4E-CMP	Commercial paging console with gooseneck microphone and pushbutton panel	-	
980050008	4E-LCF6/ENC	Speaker 100V AC, 6/3/1.5W, 98,4dB	IP21	
980050009	4E-LCS6/ENC	Speaker 100V AC, 10/6/3/1.5W, 102,2dB	IP21	



ANALOGUE
ADDRESSABLE
FIRE DETECTION
SYSTEM

LEGACY EDITION



ANALOGUE ADDRESSABLE FIRE DETECTION SYSTEM



The BSR - 2100 is a 2 or 4 loop addressable fire detection panel with expansion capabilities that can upgrade the panel to 8 loops. For compliance with LPCB approval, the maximum number of loops connected must not exceed 4. The panel is designed and constructed according to EN54 - 2 and EN54 - 4 regulations. Each loop can accept up to 150 total points, which can be input units (detectors, call points), output units and line isolators.

For compliance with LPCB approval, the maximum number of fire detectors and manual call points connected to a panel must not exceed 512.

All units that are connected to the loop are referenced and displayed on the LCD panel with the general term «POINTS» and in this term we will be referred to throughout this manual.

Each point has a specific address ranging from 1 to 150 in each loop. Each loop can accept various types of points. We will refer to these points later on in the manual. The panel has 96 zones and is suitable for larger installations such as malls, shopping centers, hotels and factories.

It offers an extensive selection of settings and options for controlling the equipment and sirens of the installation which can easily be modified using PC based software. The panel's programming can also be done using a PC.

Dimensions

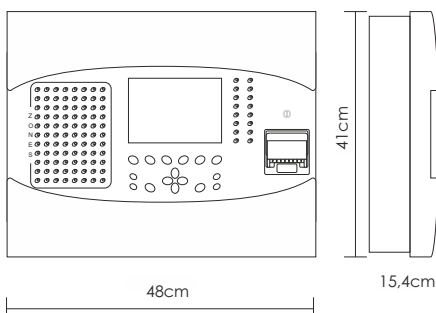

Technical Characteristics

	BSR-2104 Addressable fire detection panel 2 loops / 96 zones	BSR-2114 Addressable fire detection panel 4 loops/ 96 zones
Power Supply	220-240V AC/50-60HZ	
Battery type	2 lead batteries sealed 12V / 7-15Ah	
Consumption	100 VA	
Loop circuit	24V up to 200 mA (quiescent state). Each loop can accept up to 150 points. Each loop is protected with a self - resetable fuse. For compliance with LPCB approval, the maximum number of fire detectors and manual call points connected to a panel must not exceed 512	
Siren circuit	4 circuits 24V/500 mA, monitored for open and short circuits. Each output is protected with a self - resetable fuse	
Output Vout	24 VDC (+ - 4 VDC + - ripple 1V peak to peak) continuous output with max current 0,5 A. Each output is protected with a self - resetable fuse	
Output Fault	Open collector output (max 30VDC/6mA)	
Output Alarm	Open collector output (max 30VDC/6mA)	
Total loads (Imax)	The total load on the (loops, sirens, outputs VOUT, relay) must not exceed 2A. Imax.a=Imax.b = 2A	
Structural characteristics		
Cover protection	IP 30	
Construction materials	electrostatically painted steel	
Dimensions (LxHxW)	480 x 410 x 154 mm	
Weight	7Kgr	7,2Kgr

CODE	TYPE	DESCRIPTION	kg
921210400	BSR-2104	Addresable fire detection panel 2 loops/ 96 zones	9660 gr.
921211400	BSR-2114	Addresable fire detection panel 4 loops/ 96 zones	9901 gr.

GRAPHICAL ENVIRONMENT SOFTWARE FOR FIRE DETECTION SYSTEM MANAGEMENT

CODE	TYPE	DESCRIPTION
921100100	CMI-1001	Visual software monitor BSR-21xx

DEVICE FOR CONNECTION WITH PC

CODE	TYPE	DESCRIPTION
921485100	BMS-485	Device for connection BSR-21xx with PC

ADDRESSABLE FIRE DETECTION PERIPHERAL DEVICES FOR PANELS BSR-21xx

CODE	TYPE	DESCRIPTION
921214200	BSR-2142	Thermal printer for BSR-2xxx
921200001	BSR-2000	Repeat panel for BSR-2xxx
980210001	BOX-2100/WP **	Waterproof metal box for BSR-2xxx panels

**Trade product



BSR-2142



BSR-2000



BOX-2100/WP



ADDRESSABLE DETECTORS



CODE	TYPE	DESCRIPTION		VOLTAGE	STANDBY/ALARM CURRENT	kg
921605502	BSR-6055/A*	Optical smoke detector	IP20	21-28V DC	1mA/1,5mA	198,5 gr.
921605700	BSR-6057/A	Optical smoke/rate of rise heat detector	IP20	21-28V DC	1mA/1,5mA	199 gr.
921606002	BSR-6060/A*	Rate of rise heat detector	IP20	21-28V DC	1mA/1,5mA	178 gr.

Dimensions

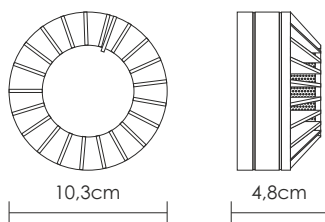

ACCESSORIES				VOLTAGE	STANDBY/ALARM CURRENT	kg
CODE	TYPE	DESCRIPTION				
921196000	BASE-196/N	Waterproofing box for fire alarm sensor base with cable glands	IP20			160 gr.
921602400	BASE-6024/SB	Addressable detector's base with siren and beacon	IP20	14-30V DC	0mA/2,6mA	150 gr.



BASE-196/N



BASE-6024/SB



1405



SHORT CIRCUIT LOOP ISOLATOR

CODE	TYPE	DESCRIPTION	 VOLTAGE	STANDBY/ALARM CURRENT	
921707100	BSR-7071/A	Short circuit loop isolator for detectors base	IP20 21-30V DC	200µA/3mA	130 gr.

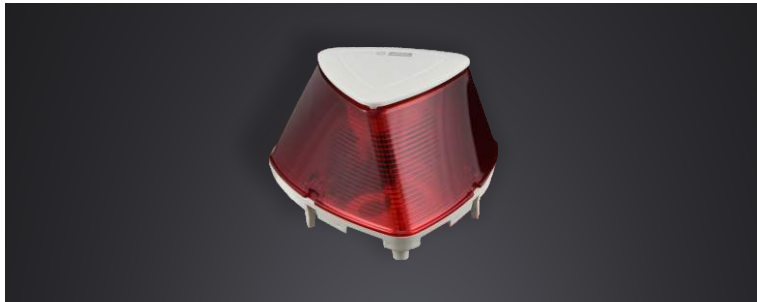

ADDRESSABLE SIREN

EVPU

CODE	TYPE	DESCRIPTION	 VOLTAGE	STANDBY/ALARM CURRENT	
921503200	BSR-5032	Addressable siren with beacon, 87dB	IP42 21-28V DC	1mA/20mA	311,5 gr.

 The packaging contains 15pcs.

Dimensions

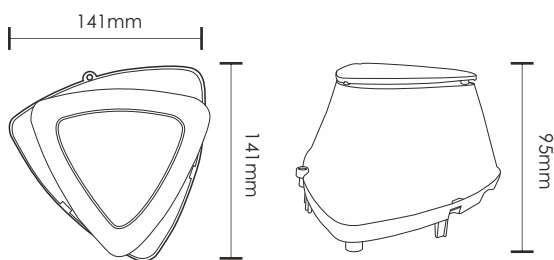



ANALOG ADDRESSABLE MANUAL CALL POINT

EVPÜ



CODE	TYPE	DESCRIPTION	VOLTAGE	STANDBY/ALARM CURRENT	kg
921503602	BSR-5036/A	Fire alarm manual call point	IP20 21-28V DC	1mA/1.5mA	219,5 gr.

Dimensions

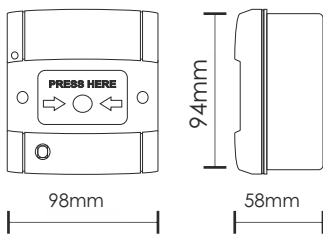

WATERPROOFING CASE

CODE	TYPE	DESCRIPTION	
927535000	BOX-535	Waterproofing case for fire alarm call point (fire alarm call point is not included)	IP65

Dimensions

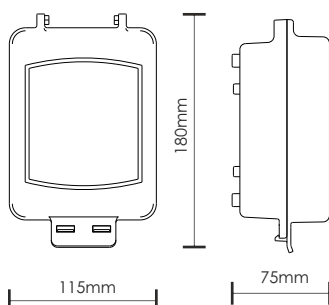

Side view

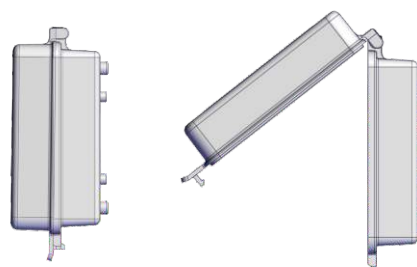

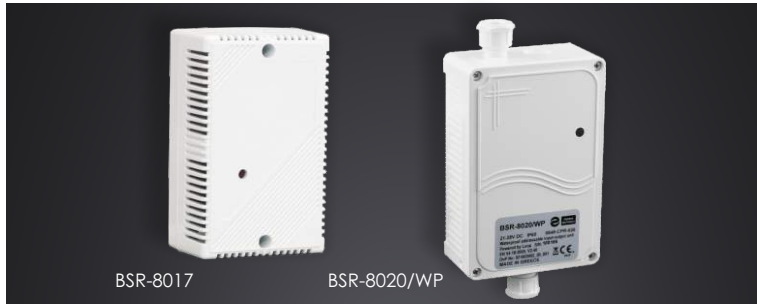

ADDRESSABLE I/O UNIT

CODE	TYPE	DESCRIPTION	VOLTAJE	STANDBY/ALARM CURRENT	kg
921801700	BSR-8017	Addressable input-output unit	IP20 21-28V DC	1mA/1mA	164 gr.
921802002	BSR-8020/WP	Addressable waterproof I/O input	IP65 21-28V DC	0,7mA/1,3mA	218 gr.

Dimensions

BSR-8017

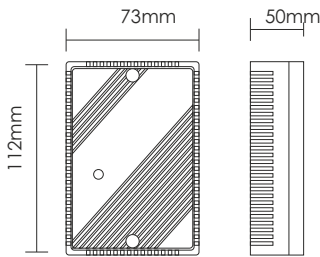

BSR-8020/WP

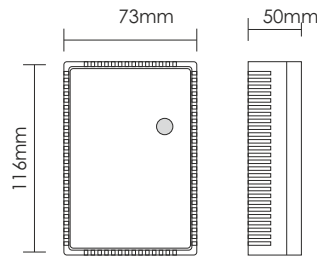

SHORT CIRCUIT LOOP ISOLATOR

Suitable for codes BSR-2104, BSR-2114

EN 54-17

CODE	TYPE	DESCRIPTION	VOLTAJE	STANDBY/ALARM CURRENT	kg
921707001	BSR-7070/A	Short circuit loop isolator	200µA 14-30 DC	200µA/3mA	88 gr.



ADDRESSABLE PERIPHERAL DEVICE

Suitable for codes BSR-2104, BSR-2114

CODE	TYPE	DESCRIPTION	 VOLTAGE	 STANDBY/ALARM CURRENT	
921214300	BSR-2143	Programming & testing unit	IP20 2x9V Alkaline Battery	60mA	588 gr.



ADDRESSABLE PERIPHERAL DEVICE

CODE	TYPE	DESCRIPTION	 VOLTAGE	STANDBY/ALARM CURRENT	
921507200	BSR-5072	Remote detector LED	IP40 + / - R	- /1mA	67 gr.

 The packaging contains 15pcs.

GAS DETECTION



ANALOG GAS DETECTION SYSTEMS

The increasing use of gases (liquefied petroleum gas or natural gas) in domestic use and the industrial use of flammable or toxic gases creates the need to detect possible leaks.

Especially in industry, in places where people used to work and could understand a leak relatively easily, now there are only machines. But the risk of fire or explosion from a flammable gas leak is the same. Toxic gas leaks must also be detected in places where humans can be found.

There are cases where gas detection is required by law. Some examples are:

- The detection of carbon monoxide in underground or covered parking lots.
- The detection of alcohol vapors in wineries and alcoholic beverage packaging plants.
- The detection of ammonia leakage in areas with professional refrigerators.

- The detection of acetylene leakage in machine shops and car repair shops.

In such cases the types of detectors and the type of installation are also determined by laws and regulations.

There are also cases where detection is required by common sense and the need to protect property.

The detection of carbon monoxide in the burner area or the detection of a gas leak in a kitchen are not required by any law, but they make our daily life safer.

In the following pages you will find detection devices for use in heavy industry, dangerous areas, business premises and homes. You will also find tables for handling professional detectors.





ANALOG GAS DETECTION PANEL

The gas detection panel BS-30x series, carries up to 16 inputs which are compatible with 4-20mA sensors, both for 2 and 3 contacts. The system is able to be programmed into 3 alarm levels and each level can be assigned to 3 different relays, in order to customize and specify the required sensitivity as well as the overall control of the system.

The BS-30x series can incorporate up to 17 relays in total, up to 16 dedicated relays to each input and one Auxiliary relay. All of them are fully programmable and can all be assigned to different alarm levels, in order to connect them to associated electro-valves or other peripherals that control the gas supply.

In the AUX relay can be connected several different peripherals such as sirens, beacons, bells, electro valves or any other peripheral that is dry-contact operated.

The inputs support different types of 4-20mA gas detectors (e.g LPG, Carbon Monoxide, etc.) and can be set individually in terms of sensitivity thresholds, units, range and more.

Furthermore, the BS-304 panel is manufactured in conformance of EU directives and specifically based on the following EU Standards: EN 50270:2006, EN 60335-1:2012+A11:2014+AC:2014, EN 50194-1:2009

Dimensions

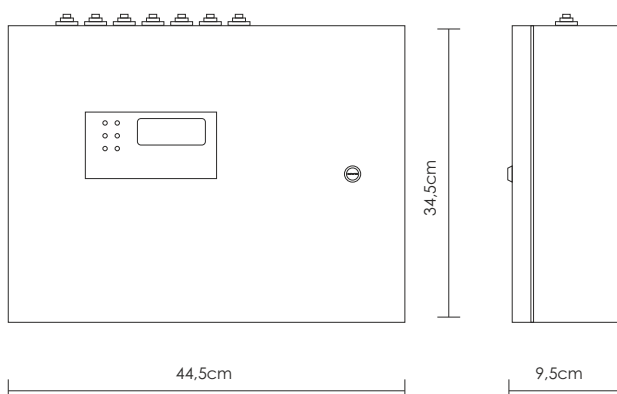

Technical specifications for the gas detection panels

	BS-304 4 detectors 4-20mA	BS-308 8 detectors 4-20mA	BS-312 12 detectors 4-20mA	BS-316 16 detectors 4-20mA
Power Supply	220-240V AC / 50-60HZ			
Consumption	23W / 60VA			
Battery Type	12V / 7Ah Pb or 2X12V / 7Ah			
Charge Circuit	Power supply 13.8V / 500mA			
Inputs	4+AUX	8+AUX	12+AUX	16+AUX
Programmable relays (5A/230V)	5	9	13	17
Outputs	Standard output 20V / 300mA			
IP Rating	IP30			
Operating temperature range	5 - 40°C			
Humidity	Up to 95% humidity			
Dimensions	445 x 345 x 95 mm			
Weight	6160gr.			
Produced in accordance with	EN 62368, EN 61000-6-1, EN 61000-6-3			
Warranty	2 years			

CODE	TYPE	DESCRIPTION		
921304000	BS-304	4 inputs 4-20mA	60VA	4080 gr.
921308000	BS-308	8 inputs 4-20mA	60VA	4210 gr.
921312000	BS-312	12 inputs 4-20mA	60VA	4330 gr.
921316000	BS-316	16 inputs 4-20mA	60VA	4060 gr.

EXPANSION UNIT FOR GAS DETECTION PANELS			
CODE	TYPE	DESCRIPTION	
927304000	A-304	4 zone expansion unit for Gas Detection Panels	176 gr.

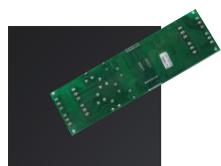

A-304



ANALOG GAS DETECTORS 4-20mA ANTI-EXPLOSIVE TYPE



II 2 G Ex d IIC T6 Gb, -20°C ≤ Ta ≤ + 60°C

CODE	TYPE	DESCRIPTION	OUTPUT	Water	Lightning	SENSOR TYPE	kg
980110004	TC100N/LPG	Gas	4-20 mA	IP55	2W	Catalytic	1164 gr.
980110006	TC100N/CNG	Natural Gas	4-20 mA	IP55	2W	Catalytic	1186 gr.
980110008	TC100N/PETROL	Petrol	4-20 mA	IP55	2W	Catalytic	1186 gr.

The packaging contains 8pcs.

Dimensions

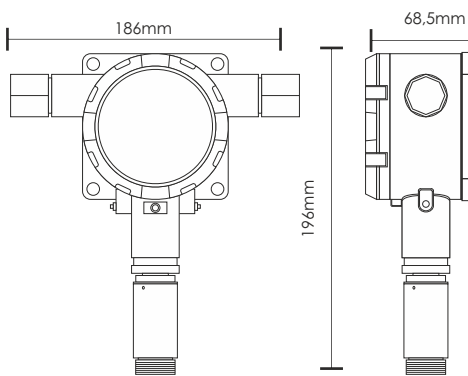

ANALOG GAS SENSORS 4-20mA ANTI - EXPLOSIVE TYPE



II 2 G Ex d IIC T6 Gb, -20°C ≤ Ta ≤ + 60°C

CODE	TYPE	DESCRIPTION	OUTPUT	Water	Lightning	SENSOR TYPE
980390000	TS293KG	LPG gas	4-20 mA	IP65	2W	Catalytic
980391000	TS293KM	Natural Gas	4-20 mA	IP65	2W	Catalytic
980393000	TS293EA	Ammonia	4-20 mA	IP65	2W	Electrochemical
980129304	TS293PX*	Various Gases*	4-20 mA	IP65	2W	Catalytic
980293002	TS293PX-H**	Various Gases**	4-20 mA	IP65	2W	Catalytic
980129300	TS293EO	Oxygen	4-20 mA	IP65	2W	Electrochemical
980129305	TS293ES	Sulfur dioxide	4-20 mA	IP65	2W	Electrochemical
980129306	TS293KI	Hydrogen	4-20 mA	IP65	2W	Catalytic

Dimensions

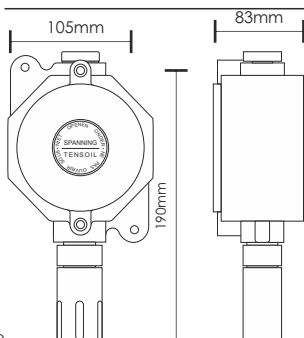

* Acetone, Isopropyl alcohol, Ammonia, Hexane, Heptane, Ethanol, Ethylene, Methanol, Toluene, Gasoline

** A wide range of gases such as: Hydrogen Sulfide, Ethyl methyl ether, Chloromethane, Aniline, Hydrogen Cyanide, Acetylene, Xylene



WATERPROOF ANALOG GAS SENSORS 4-20mA

CODE	TYPE	DESCRIPTION	OUTPUT	IP	Power	SENSOR TYPE	kg
980380000	TS282KG	LPG gas	4-20 mA	IP65	2W	Catalytic	404 gr.
980381000	TS282KM	Natural Gas	4-20 mA	IP65	2W	Catalytic	404 gr.
980382000	TS282EC-S	Carbon monoxide	4-20 mA	IP65	2W	Electrochemical	404 gr.
980383000	TS282EA-H	Ammonia for hazardous environment	4-20 mA	IP65	2W	Electrochemical	404 gr.
980383001	TS282EA	Ammonia	4-20 mA	IP65	2W	Electrochemical	404 gr.

Dimensions

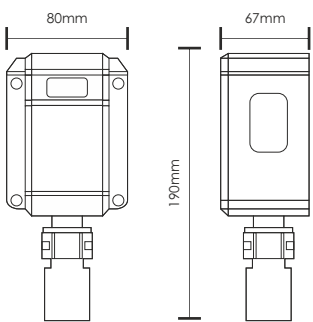

GAS DETECTORS FOR USE WITH FIRE DETECTION PANELS

CODE	TYPE	DESCRIPTION	VOLTAGE	IP	Power	SENSOR TYPE	kg
980165800	BS-658	Carbon Monoxide Detector	24V + 25%	IP66	2W/channel	Electrochemical	390 gr.
921375000	BS-375/WP/A	Liquid gas-LPG with 2 relays (24V)	10-30V DC / 17,5-21V AC	IP65	3VA	Catalytic	225 gr.
921376000	BS-376/WP/A	Natural Gas-methan with 2 relays (24V)	10-30V DC / 17,5-21V AC	IP65	3VA	Catalytic	223 gr.

The packaging contains 54pcs.

Dimensions

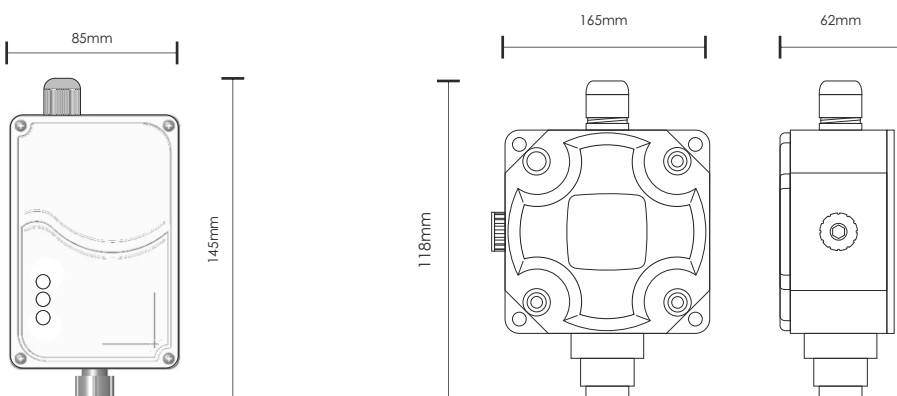

AUTONOMOUS GAS DETECTION DEVICES



AUTONOMOUS WATERPROOF DETECTOR 230V

CODE	TYPE	DESCRIPTION	VOLTAGE			SENSOR TYPE	
921377000	BS-377/WP/A	Liquid Gas-LPG with 2 relays (230V)	197-265V AC	IP65	3VA	Catalytic	338 gr.
921378000	BS-378/WP/A	Natural Gas-methane with 2 relays (230V)	197-265V AC	IP65	3VA	Catalytic	338,5 gr.

The packaging contains 54pcs.

ACCESSORY			
CODE	TYPE	DESCRIPTION	
927375000	A-375	Detector sensor for BS-375, BS-376, BS-377, BS-378	4 gr.

Dimensions

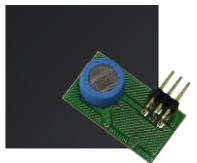
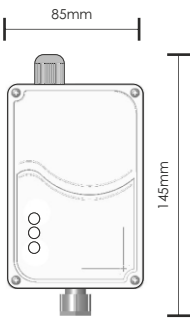

GAS DETECTORS FOR USE WITH FIRE DETECTION PANELS

CODE	TYPE	DESCRIPTION	VOLTAGE			
921685000	BS-685	Waterproof LPG detector	10 - 30V AC - DC (Powered by panel)	IP65	0,5W	150 gr.
921686000	BS-686	Waterproof natural gas-methane detector	10 - 30V AC - DC (Powered by panel)	IP65	0,5W	150 gr.

Dimensions





AUTONOMOUS GAS DETECTION & DEVICES (230V AC)

CODE	TYPE	DESCRIPTION	VOLTAGE			SENSOR TYPE	
BS-690	921690000	LPG detector with beacon& fire detection zone with output relay	220-240V AC	IP40	32VA	Catalytic	268 gr.
BS-691	921691000	Natural gas detector with beacon & fire detection zone	220-240V AC	IP40	32VA	Catalytic	263 gr.
BS-694	921694000	LPG detector 230V with output relay	220-240V AC	IP40	4VA	Catalytic	291 gr.
BS-695	921695000	Natural gas detector 230V with output relay	220-240V AC	IP40	4VA	Catalytic	283 gr.
SE-325EC	980132500	Autonomous carbon monoxide detectors with battery 3V li		IP42	-	Electrochemical	281 gr.
LPM 2610	328000014	Spare sensor PG for BS-690, BS-694, BS-685, BS-687	Battery 3V/1400mA				3 gr.
NGM 2611	328000013	Spare sensor Natural gas for BS-691, BS-695, BS-686, BS-688					3 gr.

Dimensions

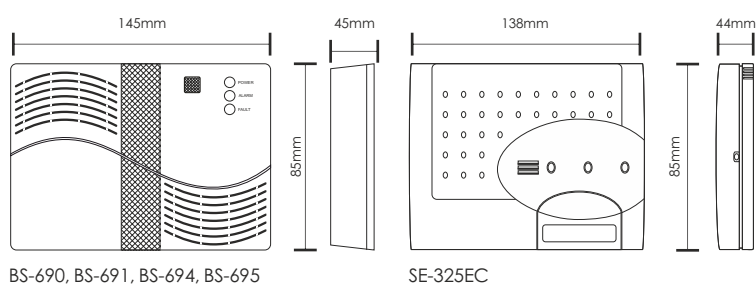

BS-690, BS-691, BS-694, BS-695

SE-325EC



SPECIAL USE DEVICE

CODE	TYPE	DESCRIPTION	VOLTAGE			
921162000	BS-162	Module for 12V electro-valves	11-15V DC	IP20	15mA	182,5 gr.
921164000	BS-164	Activation module for 24V electro-valves	11-15V DC	IP20	30mA	201 gr.

INDEX

Type	Page
4E-EOL	35
4E-FMT	35
4E-LCF6/ENC	35
4E-LCS6/ENC	35
4E-CMP	35
A-1214	5
A-200	5
A-200/ETHERNET	5
A-4541 ADAM	26
A-940	5
A-961	5
A-986	5
BASE-196/N	8
BASE-6024	17
BASE-6024/SB	8
BMS-485	39
BOX-2100/WP	39
BOX-530	26
BOX-535	6
BOX-537	31
BS-162	57
BS-1620	14
BS-1632	15
BS-1634	15
BS-1636	15
BS-1638	13
BS-164	57
BS-1640	13
BS-1641	13
BS-1642	13
BS-1646	13
BS-3001	24
BS-3002	24
BS-304	51
BS-308	51
BS-312	51
BS-316	51
BS-375/WP/A	53
BS-376/WP/A	53
BS-377/WP/A	56
BS-378/WP/A	56
BS-505	25
BS-505/WP	25
BS-506/ALKALINE	27
BS-506/LITHIUM	27
BS-506/WL	27
BS-510/24	22
BS-521/1	25
BS-521/1/WP	25
BS-527/WP/V2	23
BS-528	23
BS-531/1	18
BS-532/WP	18
BS-533	31
BS-534	31
BS-536	16
BS-536/B	26
BS-536/G	26
BS-536/W	26
BS-537	23
BS-542	24
BS-546	25
BS-572	9
BS-572	19
BS-576/L	24
BS-580	24
BS-595/A	19
BS-615	13
BS-6155	8
BS-627	31
BS-637	31
BS-655/A	17
BS-657/A	17
BS-658	53
BS-660/A	17
BS-661	17
BS-685	56

Type	Page
BS-686	56
BS-690	57
BS-691	57
BS-694	57
BS-695	57
BSR-1000	5
BSR-1001	5
BSR-1002	5
BSR-1004	5
BSR-1004/MODBUS	5
BSR-100X/ETHERNET-MODBUS	5
BSR-100x/ETHERNET-PRINTER	5
BSR-2000	39
BSR-2104	39
BSR-2114	39
BSR-2142	39
BSR-2143	45
BSR-5032	42
BSR-5036/A	43
BSR-5072 Ip40	45
BSR-5130	42
BSR-5130/WP	42
BSR-5132/WP	7
BSR-5136	6
BSR-6055/A	40
BSR-6057/A	40
BSR-6060/A	40
BSR-6155	8
BSR-6155/WB	8
BSR-6157	8
BSR-6157/WB	8
BSR-6160	8
BSR-6160/WB	8
BSR-7070/A	44
BSR-7071/A	44
BSR-8017	44
BSR-8020/WP	44
BSR-8120	9
C500/3+1	35
C500-RS422-T	35
CMI-1101	5
FIRERAY ONE	22
FIRERAY ONE+1010-000	22
GR-24/12V/A	23
GR-24/24V/A	23
GR-8530	5
LPM 2610	57
NGM 2611	57
OLYMPIA GATEWAY	5
PC-1000	5
SE-325EC	57
SOLO TEST-KIT 814-101	22
TC100N/CNG	52
TC100N/LPG	52
TC100N/PETROL	52
TESTIFIRE 6001 Smoke/heat Testkit	22
TS282EA	53
TS282EA-H	53
TS282EC-S	53
TS282KG	53
TS282KM	53
TS293EA	52
TS293EO	52
TS293ES	52
TS293KG	52
TS293KI	52
TS293KM	52
TS293PX	52
TS293PX-H	52
A-304	51
A-375	56
A-485 ADAM 45105	26
A-510/24	22
A-533	16
A-536	16
A-632	15
BSR-5130/WP	7

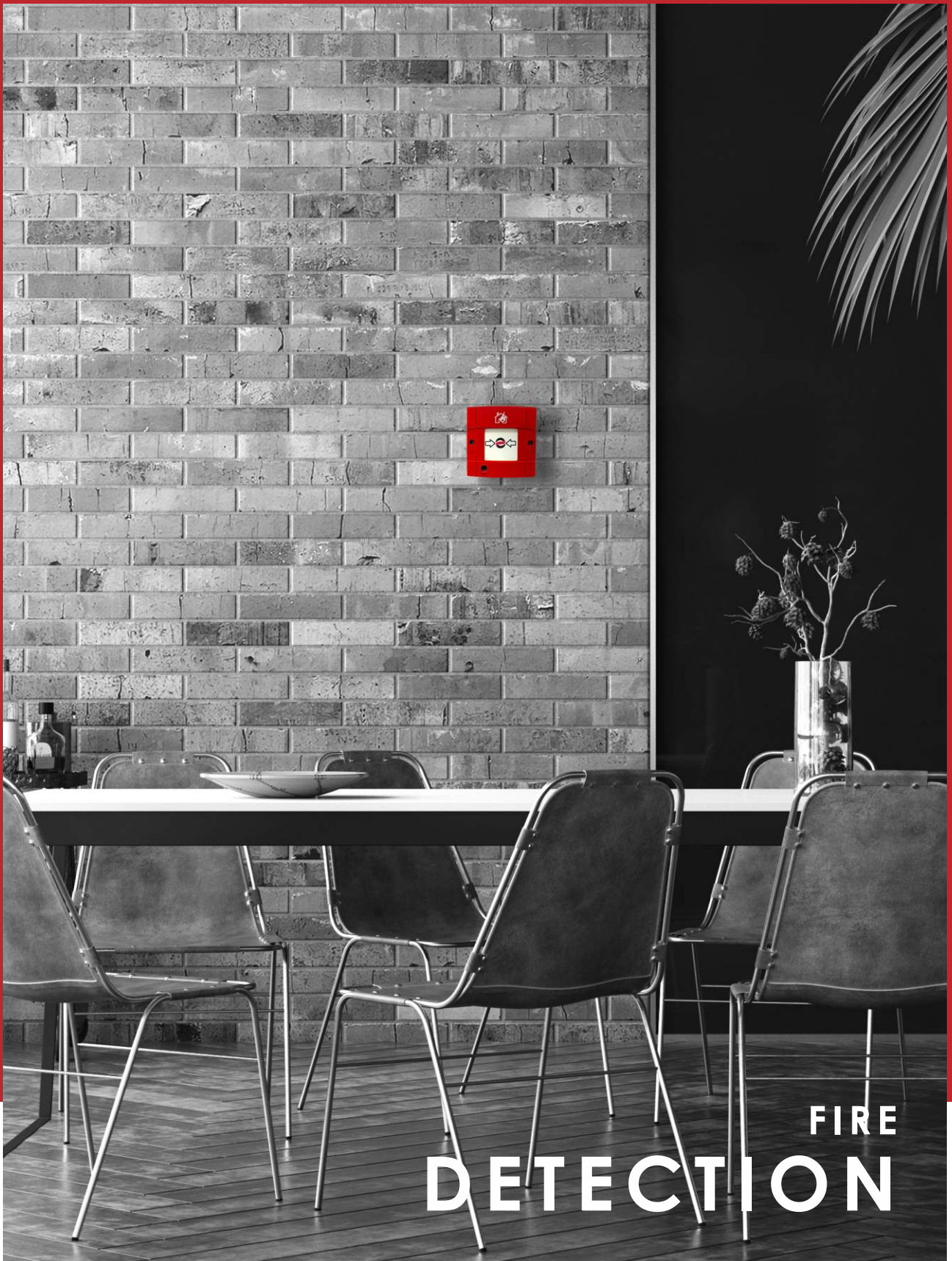

est. 1979
**olympiaTM
electronics**
SAFETY & SECURITY SYSTEMS

for a safer world!

www.olympia-electronics.com

The company is certified by
APPROVAL
SWISS
Objectively True
ISO 14001, ISO 45001, ISO 9001

