

# EMERGENCY LIGHT 2021 CATALOGUE ING



[www.olympia-electronics.com](http://www.olympia-electronics.com)



*for a safer world*



*for a safer world!*

## Our mission

To be among the most innovative European companies in the Electronic Safety & Security Systems industry.

## Our philosophy

Produce high quality, state-of-the-art, innovative products at a competitive price level. Be an 'Easy To Do Business With' company. Be customer-focused and provide excellent service.

# Exports to 72 countries



est. 1979

olympia<sup>TM</sup>  
electronics

SAFETY & SECURITY SYSTEMS

*for a safer world!*

## OUR COMPANY

since 1979

Innovative electronic safety and security systems

200 employees with more than 10% in R & D department

Strong presence in over 72 countries

Purely Greek company

Certified products according to the European Norms

## PRODUCTS

Emergency lighting

Fire detection systems

Gas detection systems

Burglar alarm and security systems

Electronic room thermostats

[Emergency lighting & fire detection systems for marine applications](#)

## QUALITY

OLYMPIA ELECTRONICS S.A. aiming in the quality, has adopted in the last years, production and inspection procedures that have supplied the market with products that are totally in accordance with European Norms (EN).

For the production, the company applies advanced systems "world class manufacturing" such as lean systems, TPM, 5S which give it competitive advantages.

Its products allocate certificates from various certification bodies such as: LPCB, EVPU, BSI, e.t.c.

The company applies a complete management system IQMS "oly q" which include quality management systems, as well as environmental, hygiene and personnel safety management systems.

Olympia Electronics S.A. has been certified according to ISO9001, OHSAS 18001, ISO 140001.

## EXPORTS

We export to 72 countries:

European Union

Eastern European countries & Russia

Middle East and Gulf States

Africa

U.S.A

Australia

## CERTIFICATIONS

EVPU



CE



EAC

1. KPMG-00081  
BS EN 60598-2-22  
2. KPMG-00086  
BS EN 60334  
3. KPMG-00088  
BS EN 61347-2-7  
4. KPMG-01103  
BS EN 50174

APPROVAL  
**SWISS**  
Objectively True



1010/01  
1010/02  
1010/01  
1010/02  
1010/01  
1010/02  
1010/01  
1010/02



# REFERENCES

## HOTELS

Asplund Hotel / Sweden, The Westin Resort Costa Navarino, Kalamata / Greece, Movenpick, Petra / Jordan, Hilton, Athens / Greece, Hotel Pullman ZamZam Makkah / Saudi Arabia, Le Royal Hotel, Dbayah / Lebanon, Grand Hotel Palace, Thessaloniki / Greece, King George, Athens / Greece, Akti Imperial Deluxe Resort & Spa, Rhodes/ Greece, Sideri, Mykonos/ Greece, Aqua Blue, Santorini/ Greece, Orycheio, Santorini/ Greece, Palmyra, Glifada/ Greece, Acropol, Athens/ Greece, Kalamaki Beach, Korinthos/ Greece, Artemis, Kos/ Greece, Casa Cook, Kos / Greece Continental, Kos / Greece, Aggrelli, Kos / Greece, Origin Hotel & Appartments, Kos / Greece, Atlantica Thalassa, Kos / Greece, Marmari Beach, Kos/ Greece, Amada Colossos, Rhodes / Greece





## MISCELLANEOUS INSTALLATIONS

Luxembourg Science Center / Luxembourg,  
 Trilogy Limassol / Cyprus , Belgrade National  
 Museum / Serbia, Farwaniya Hospital / Kuwait,  
 Y.M.C.A Thessaloniki /Greece,  
 Hushagsgymnasiet school / Sweden,  
 Sportsarena Anglagarden / Sweden, Kleanthis  
 Vikelidis Stadium, Thessaloniki /Greece,  
 Happel Stadium / Wien , Austria, Frescati  
 university library / Sweden, Schwerin metro /  
 Germany, Better Life Appliances for Cayan  
 Tower/ Dubai, 132/33kv Kadrah Grid Station /  
 Oman, Desert Night Camp / Oman, 33kv  
 Tumrait Sub Station / Oman, 33kv SOHAR Sub  
 Station / Oman, Olympic village / Greece,  
 Twin Tower / Lebanon, Kadrah Grid Station /  
 Oman, ARGO Offices / Prague, Czech  
 Republic Prioritet Serneke Arena / Sweden,  
 Press center of the Olympic games / Rio,

Brazil, Orebro Castle/ Sweden Metropolitan  
 Medical Center, Athens/ Greece,  
 Cardiological Clinic of Tzaneio Hospital,  
 Athens/ Greece, General Hospital, Athens/  
 Greece, Hospital Paidon Pentelis, Athens/  
 Greece, Hellenic Open University/ Greece,  
 Ralleios School of Peiraia/ Greece, General  
 High School, Tripoli/ Greece, School Complex  
 Moraitis, Athens/ Greece, 16th School  
 Complex of Patra / Greece, 5th Nursery  
 School, Athens/ Greece, OTE Building ,  
 Athens/ Greece, OTE Building Ampelokipoi,  
 Athens/ Greece, Law Office Building "Sioufas"  
 , Athens/ Greece, Teleperformance  
 Company , Athens/ Greece, Warehouse of  
 tiles "Lakiotis Company", Athens/ Greece,  
 Corporate Offices "Nestle", Malta

## AIRPORTS

Arlanda Airport / Sweden, Landvetter  
 Airport / Sweden, Macedonia Airport /  
 Greece, Lisbon, Airport / Portugal, New  
 Delhi Airport / India, Frankfurt Airport /  
 Germany, El. Venizelos/ Greece Doha  
 International airport / Qatar, Oslo  
 Airport / Norway, Santorini / Greece,  
 Aristarhos of Samos / Greece

## SHOPPING CENTERS

Armada shopping center / UK, Solaris  
 shopping center / Esthonia, Bergvik  
 shopping center / Sweden, Shopping  
 center Mitt I city / Sweden



# REFERENCES

## RESIDENTIAL APARTMENTS

Wien, Austria / Raffaelgasse 27 1200,  
Satzingerweg 64 1210,  
Breitenfuhrterstrasse 223 BPL 4-6 1230,  
Ernstbrunn, Austria / Dr. Steiner-Gasse 2  
2115, Graz, Austria / Waagner Biro  
Stasse 69 8020, Taxach, Austria /  
Ringweg 33 5400 RIFerside, Beograd  
Waterfront, Serbia/ Phase B, USCE II,  
Belgrade, Serbia / Final Phase

## PUBLIC PROJECTS

National Road Network Athens -  
Thessaloniki/ Greece, National  
Road Network Athens- Kalamata/  
Greece, Egnatia Odos / Greece,  
Underwater Tunnel Actio/ Greece,  
Rio-Antirio Bridge/ Greece





## MISCELLANEOUS INSTALLATIONS

Luxembourg Science Center / Luxembourg,  
 Trilogy Limassol / Cyprus , Belgrade National  
 Museum / Serbia, Farwaniya Hospital / Kuwait,  
 Y.M.C.A Thessaloniki /Greece,  
 Hushagsgymnasiet school / Sweden,  
 Sportsarena Anglagarden / Sweden, Kleanthis  
 Vikelidis Stadium, Thessaloniki /GreeceHappel  
 Stadium / Wien , Austria, Frescati university  
 library / Sweden, Schwerin metro / Germany,  
 Better Life Appliances for Cayan Tower/  
 Dubai, 132/33kv Kadrah Grid Station / Oman,  
 Desert Night Camp / Oman, 33kv Tumrait Sub  
 Station / Oman, 33kv SOHAR Sub Station /  
 Oman, Olympic village / Greece, Twin Tower  
 / Lebanon, Kadrah Grid Station / Oman,  
 ARGO Offices / Prague, Czech Republic  
 Prioritet Serneke Arena / Sweden, Press center  
 of the Olympic games / Rio, Brazil, Orebro

Castle/ Sweden, Metropolitan Medical  
 Center, Athens/ Greece, Cardiological Clinic  
 of Tzaneio Hospital, Athens/ Greece, General  
 Hospital, Athens/ Greece, Hospital Paidon  
 Pentelis, Athens/ Greece, Hellenic Open  
 University/ Greece, Ralleios School of Peiraia/  
 Greece, General High School, Tripoli/ Greece,  
 School Complex Moraitis, Athens/ Greece,  
 16th School Complex of Patra / Greece, 5th  
 Nursery School, Athens/ Greece, OTE Building  
 , Athens/ Greece, OTE Building Ampelokipoi,  
 Athens/ Greece, Law Office Building "Sioufas"  
 , Athens/ Greece, Teleperformance  
 Company , Athens/ Greece, Warehouse of  
 tiles "Lakiotis Company", Athens/ Greece,  
 Corporate Offices "Nestle", Malta







EMERGENCY LUMINAIRES	SLIM LEDs LIGHT	11-14
	CLASSIC LIGHT	15
	EASY LIGHT	16-21
	WEATHER LIGHT	22-29
	OLYMPUS LIGHT	30-33
	BAU LIGHT	34-35
	LINEAR LIGHT	36-37
EXIT SIGN LUMINAIRES	MLD LIGHT	42-43
	ZLD LIGHT	44-45
	CLD-30	46-47
	PLD-25	48-49
	ECO LIGHT	50-53
	LOUNGE LIGHT	54-55
	PROJECT LIGHT	56-57
	LED LIGHT BOX	58-59
	3D LIGHT	60-61
SPECIAL CATEGORY OF EMERGENCY LIGHTING	TUNEL LIGHT	62-65
	POWER LED LIGHT	66-69
	ANTI-EXPLOSIVE	70-71
	SPOT LIGHT	72-75
	TETRAGONO LIGHT	76
	WEATHER SPOT LIGHT	77
	HOME LIGHT	78
CONVERTERS	CONVERTERS	80-81
DETECTION PANEL FOR SELF-CONTAINED EMERGENCY LUMINAIRES	ADDRESSABLE LUMINAIRES	82-97
	WIRELESS LUMINAIRES	98-117
CENTRAL BATTERY SYSTEMS LPS (LOW POWER SYSTEMS)	COVENTIONAL BATTERY SYSTEM 24V DC GR-8500	118-127
	ADDRESSABLE CENTRAL BATTERY SYSTEM 24V DC GR-8600	128-137
	CONVENTIONAL BATTERY SYSTEM 230V AC GR-9500	138-154
ACCESSORIES/BATTERIES		156-159
MARKING SIGNS		
SPACING TABLES		161-181



# SLIMLEDs LIGHT

The SlimLight family are modern and discreet luminaires suitable for home or industrial use. Low consumption combined with low cost make them the best choice to meet the basic needs of small facilities, such as restaurants, shops, office buildings etc. They can be used as emergency or exit sign luminaires by applying the required pictogram.

The luminaires of the SlimLight family are initially set in continuous operation with the capability to switch them to non-continuous by changing the position of the jumper. They also have the option to set the autonomy to 1,5 or 3 hours and are divided into 2 categories:

**GR-2000:** The SlimLight family has a special luminaire, the GR-2000, with a range of 2-7 hours, adjustable via the IRT200A remote control and various other functions mentioned in the user manual.

**GR-8 & GR-9/LEDS:** Suitable for use as emergency or exit sign luminaires by applying the required pictogram. Certified by CNBOP-PIB Certification Department. They are easily installed in indoors environments, wall or ceiling mounting. With the use of A-3008 & A-3018 accessories there is an option of recessed mounting on suspended ceiling.



GR-2000

GR-2000

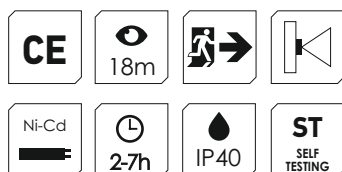



Mounting method

**Wall mounting**  
GR-2000

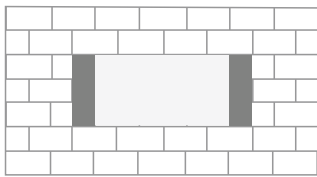

Dimensions

GR-2000

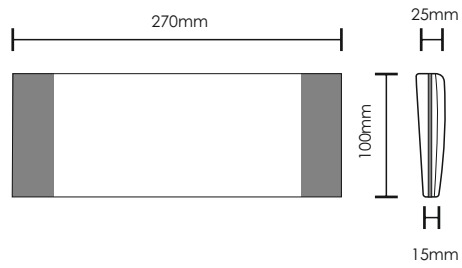

Photometric

GR-2000

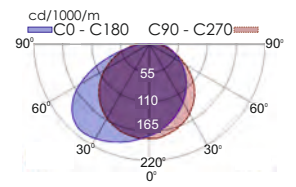

CODE	TYPE	ST	M	NM						
92320000	GR-2000, programmable	✓	✓	✓	IP40	3,6V/1Ah Ni-Cd	2-7 h	3,8W/8,2VA	125/125 lm	415 gr.

The packaging contains 12pcs.

SINGLE-SIDE PICTOGRAMS			
CODE	TYPE	DESCRIPTION	
807200007	S-20000/LO	Pictogram Left ISO single side 18m	✓
807200005	S-20000/RO	Pictogram Right ISO single side 18m	✓
807200009	S-20000/DO	Pictogram Down ISO single side 18m	✓
807200011	S-20000/UO	Pictogram Up ISO single side 18m	✓

ACCESSORIES ON DEMAND			
CODE	TYPE	DESCRIPTION	
927200000	A-2000/W	Set left - right decorative covers for GR-2000 (white color)	16 gr.
927200001	A-2000/B	Set left - right decorative covers for GR-2000 (bronze color)	16,5 gr.
927200004	A-2000/BLACK	Set left - right decorative covers for GR-2000 (black color)	16,5 gr.
927200100	IRT200A	Remote control for GR-2000 (15 keys)	32,5 gr.

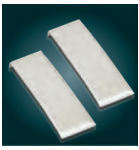

A-2000/W

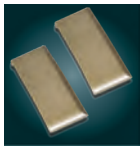

A-2000/B



A-2000/B



IRT200A

BATTERIES		
CODE	TYPE	DESCRIPTION
601233610	A-931/HT	Battery 3,6V/1Ah HT NiCd

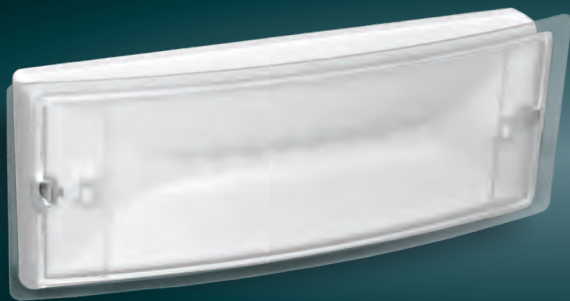

# SLIM LIGHT



CODE	TYPE	ST	M	NM	IP	Battery	Runtime	Power	Light Output	Weight
923378005	GR-8/leds	—	✓	✓	IP42	3,6V/600mAh Ni-Cd	1,5 h	2,7W/3VA	40/100 lm	396 gr.
923009007	GR-9/leds	—	✓	✓	IP42	3,6V/1Ah Ni-Cd	3 h	3W/3,5VA	38/100 lm	410 gr.

The packaging contains 20pcs.

SINGLE-SIDE PICTOGRAMS		DESCRIPTION	INCLUDED	ON DEMAND	
CODE	TYPE				
807008106	S-00802/LO	Pictogram Left ISO single side 15m	✓		
807008104	S-00802/RO	Pictogram Right ISO single side 15m	✓		
807008108	S-00802/DO	Pictogram Down ISO single side 15m	✓		
807008110	S-00802/UO	Pictogram Up ISO single side 15m		✓	

ACCESSORIES		DESCRIPTION	ON DEMAND	Weight
CODE	TYPE			kg
927300800	A-3008	Base for recessed mounting on suspended ceiling (A-3018 mounting springs are included)	✓	273 gr.
922100800	SP-1008/RLDUB	Marking panel for GR-8 -9 LEDs for all directions (Can be used only when the luminaire is installed on the ceiling)	✓	175 gr.



A-3008

Required opening for suspended wall or ceiling installation

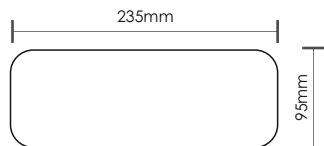

SP-1008/RLDUB

BATTERIES		DESCRIPTION
CODE	TYPE	
601223610	A-931/HT	Battery 3,6V/1000mAh NiCd
601003606	A-926	Battery 3,6V/600mAh Ni-Cd

## Mounting methods

### Wall mounting

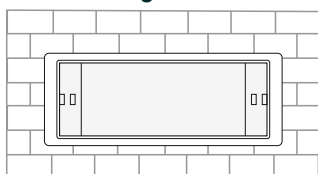

### Recessed mounting on a suspended ceiling with the A-3008 base



### Recessed ceiling mounting with the A-3008 base and the SP-1008 hanging marking panel

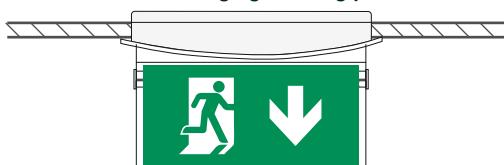

## Dimensions

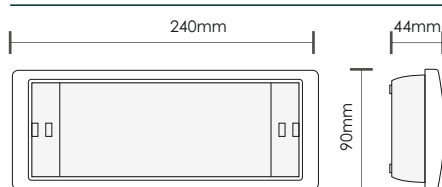

### Luminaire with the hanging marking panel

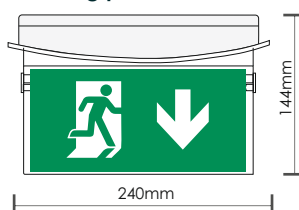

### Marking panel



## Photometric

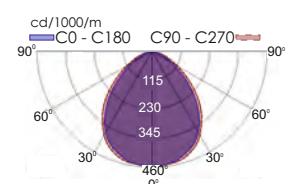



# CLASSIC LIGHT



CODE	TYPE	ST	M	NM	Water	Battery	Runtime	Power	Mains/Emergency	Weight
923151004	GR-151-3/L*	—	✓	✓	IP20	3,6V/1Ah Ni-Cd	3 h	3W / 4 VA	30/75 lm	672 gr.
923108013	GR-108/12L/90	—	✓	✓	IP20	3,6V/600mAh Ni-Cd	1,5 h	2,5W / 3VA	40/100 lm	635 gr.
923109004	GR-109/12L/180	—	✓	✓	IP20	3,6V/1Ah Ni-Cd	3 h	3W / 3,5VA	38/100 lm	635 gr.
923119007	GR-119/6L/42V/KL**	—	✓	✓	IP20	4,8V/1,5Ah Ni-Cd	1,5 h	4,7W / 8,7VA	205/340 lm	730 gr.

The packaging contains 16pcs.

SINGLE-SIDE PICTOGRAMS			
CODE	TYPE	DESCRIPTION	INCLUDED / ON DEMAND
807108007	S-10800/LO	Pictogram Left ISO single side 18m	✓ /
807108005	S-10800/RO	Pictogram Right ISO single side 18m	✓ /
807108009	S-10800/DO	Pictogram Down ISO single side 18m	✓ /
807108011	S-10800/UO	Pictogram Up ISO single side 18m	✓ /

ACCESSORIES			
CODE	TYPE	DESCRIPTION	Weight
927101500	A-1015	Base for recessed mounting on suspended ceiling	273.5 gr.



A-1015

Required opening for suspended wall or ceiling installation

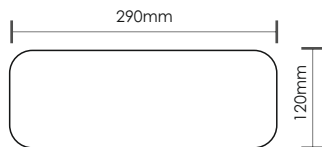

BATTERIES		
CODE	TYPE	DESCRIPTION
601233610	A-931/HT	Battery 3,6V/1000mAh NiCd
601003606	A-926	Battery 3,6V/600mAh Ni-Cd
601214815	B-973/HT	Battery 4,8V/1,5Ah HT Ni-Cd

## Mounting methods

### Wall mounting

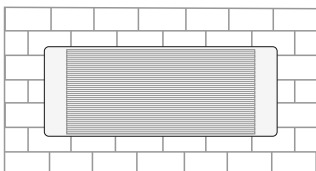

## Dimensions

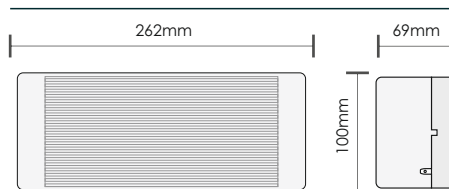

## Photometric

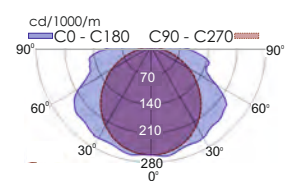

### Recessed mounting on suspended ceiling

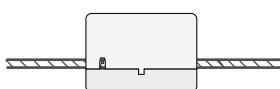





# EASY LIGHT

The Easy Light luminaire family is the cornerstone of Olympia Electronics emergency lighting systems. With a classic design and low cost, the Easy Light luminaire family has multiple versions that enable them to satisfy the demands for emergency lighting of various installations such as hospitals, hotels, and schools.

The high luminous flux output versions 4P and 6P can be used in large rooms with high ceilings whereas the availability of versions with 90 minutes, 3 hours, or 8

hours autonomy as well as the double-sided versions GR-39X/L, allow the Easy Light luminaire family to satisfy the majority of emergency lighting specifications and requirements.

The A-3018 accessory enables the recessed installation of the Easy Light luminaires on false ceilings. Additionally, the SP-116 and SP-116/P/X signs convert the luminaires to double-sided emergency exit signs.



GR-3xx/A

<b>CE</b>	26m		IP40
		Ni-Cd	<b>ST</b> SELF TESTING
	1,5-8h		

GR-13xx

<b>CE</b>	26m		IP40
		Ni-Cd	<b>ST</b> SELF TESTING
	1,5-3h		

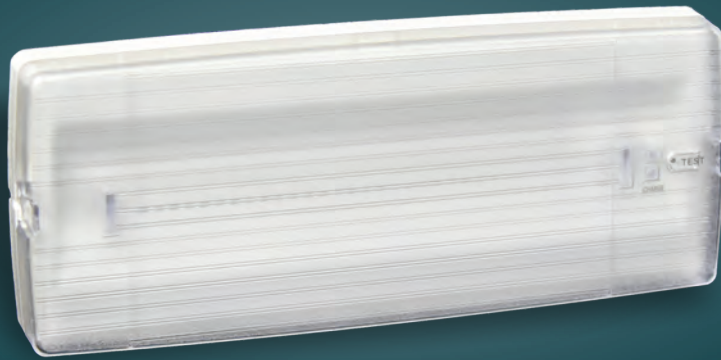

KM640081  
BS EN 60598-2-22

\*They have BSI & CNBOP-PIB certifications

## Mounting method

### Ceiling or wall mounting

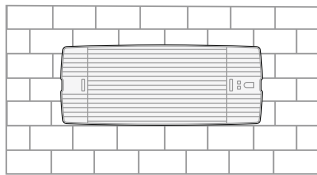

### Recessed mounting on suspended ceiling

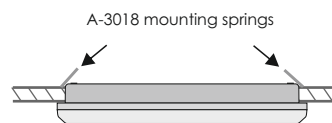

### Recessed mounting on a suspended ceiling with the A-3008 base and the SP-116 hanging marking panel



### Ceiling installation with SP-116 marking panel



### Dimensions

SP-116

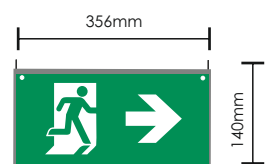

### Dimensions

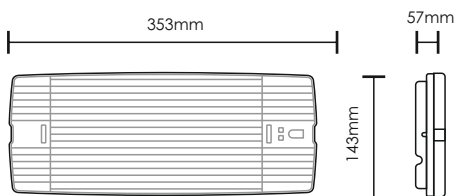

### Required opening for suspended wall or ceiling installation



### Photometric

GR-315/4P/A GR-315/6P/A

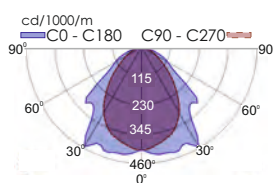

GR-315/15L/A GR-315/30L/A

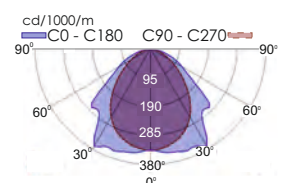

CODE	TYPE	ST	M	NM						
923315024	GR-315/15L/A*	✓	✓	—	IP40	3,6V/600mAh Ni-Cd	1,5 h	3,4W/3,8VA	105/105 lm	806 gr.
923316020	GR-316/15L/A*	✓	✓	—	IP40	3,6V/1,5Ah Ni-Cd	3 h	3,3W/3,7VA	105/105 lm	883 gr.
923315025	GR-315/30L/A*	✓	✓	—	IP40	3,6V/1,5Ah Ni-Cd	1,5 h	4,5W/4,9VA	210/210 lm	883 gr.
923316021	GR-316/30L/A*	✓	✓	—	IP40	3,6V/3Ah Ni-Cd	3 h	5,3W/5,6VA	210/210 lm	940 gr.
923315026	GR-315/4P/A	✓	✓	—	IP40	4,8V/1,5Ah Ni-Cd	1,5 h	4,7W/5,1VA	175/350 lm	940 gr.
923315027	GR-315/6P/A	✓	✓	—	IP40	4,8V/3Ah Ni-Cd	1,5 h	6,2W/6,5VA	245/480 lm	1025 gr.
923316022	GR-316/4P/A	✓	✓	—	IP40	4,8V/3Ah Ni-Cd	3 h	5,3W/5,7VA	175/350 lm	1000 gr.
923316023	GR-316/6P/A	✓	✓	—	IP40	4,8V/4Ah Ni-MH	3 h	6,2W/6,5VA	245/480 lm	1065 gr.
923308003	GR-308/15L/A	✓	✓	—	IP40	3,6V/3Ah Ni-Cd	8 h	3,7W/4VA	125/125 lm	825 gr.
923310048	GR-310/12L/180/A	—	✓	✓	IP40	3,6V/1Ah Ni-Cd	3 h	2,9W/3,2VA	38/100 lm	840 gr.
923310049	GR-310/12L/90/A	—	✓	✓	IP40	3,6V/600mAh Ni-Cd	1,5 h	2,9W/3,2VA	40/100 lm	850 gr.
923310047	GR-310/15L/A*	—	✓	✓	IP40	3,6V/600mAh Ni-Cd	1,5 h	3,1W/3,3VA	30/105 lm	838 gr.
923312026	GR-312/15L/A*	—	✓	✓	IP40	3,6V/1,5Ah Ni-Cd	3 h	3,4W/3,6VA	30/105 lm	915 gr.
923310046	GR-310/30L/A*	—	✓	✓	IP40	3,6V/1,5Ah Ni-Cd	1,5 h	3,3W/3,5VA	30/210 lm	900 gr.
923312025	GR-312/30L/A*	—	✓	✓	IP40	3,6V/3Ah Ni-Cd	3 h	4,5W/4,8VA	30/210 lm	1028 gr.
923309002	GR-309/15L/A	—	✓	✓	IP40	3,6V/3Ah Ni-Cd	8 h	4,9W/5,2VA	35/125 lm	1000 gr.

The packaging contains 15pcs.  
\*They have BSI & CNBOP-PIB certifications

#### SINGLE-SIDE PICTOGRAMS

CODE	TYPE	DESCRIPTION	INCLUDED	ON DEMAND	
807310008	S-31101/LO	Pictogram Left ISO single side 26m	✓		
807310006	S-31101/RO	Pictogram Right ISO single side 26m	✓		
807310010	S-31101/DO	Pictogram Down ISO single side 26m	✓		
807310012	S-31101/UO	Pictogram Up ISO single side 26m		✓	

#### ACCESSORIES

CODE	TYPE	DESCRIPTION	ON DEMAND	
980330180	A-3018	Suspended ceiling mounting springs	✓	10,9 gr.
922116006	SP-116/RLDUB	Double sided Plexiglass 4mm marking panel with all directions (Can be used only when the luminaire is installed on the ceiling)	✓	434 gr.



A-3018



SP-116/RLDUB

#### BATTERIES

CODE	TYPE	DESCRIPTION
601003606	A-926	Battery 3,6V/600mAh Ni-Cd
601213615	B-972/HT	Battery 3,6V/1,5Ah Ni-Cd
601214815	B-973/HT	Battery 4,8V/1,5Ah Ni-Cd
601233630	B-949/HT	Battery 3,6V/3Ah Ni-Cd
601214830	B-941/HT	Battery 4,8V/3Ah Ni-Cd
601134840	B-936/HT60SC	Battery 4,8V/4Ah Ni-Mh
601233610	A-931/HT	Battery 3,6V/1Ah Ni-Cd

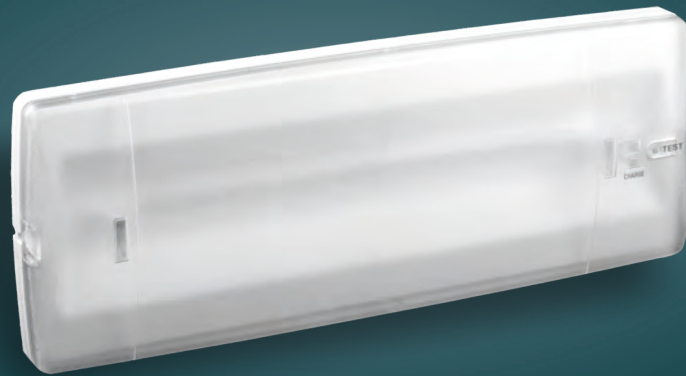

KM640081  
BS EN 60598-2-22

\*They have BSI & CNBOP-PIB certifications

## Mounting method

### Ceiling or wall mounting

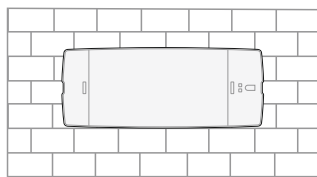

### Recessed mounting on suspended ceiling

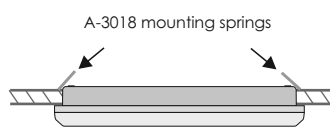

### Recessed mounting on a suspended ceiling with the A-3008 base and the SP-116 hanging marking panel



### Ceiling installation with SP-116 marking panel



## Dimensions

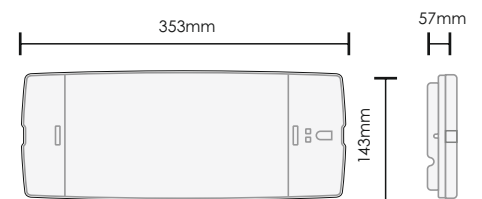

Required opening for suspended wall or ceiling installation

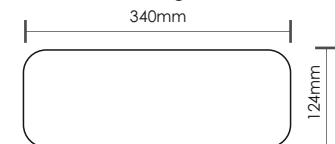

## Dimensions



## Photometric

### GR-1310-4P

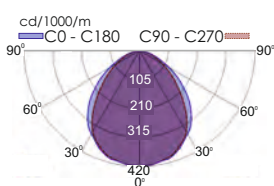

### GR-1310-6P

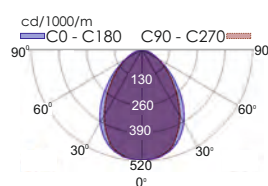

### GR-1310-15L

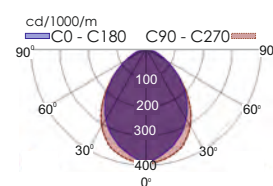

Internal selection - without LI

CODE	TYPE	ST	M	NM						
923131500	GR-1315/15L*	✓	✓	—	IP40	3,6V/600mAh Ni-Cd	1,5 h	3,4W/3,8VA	105/105 lm	787 gr.
923131600	GR-1316/15L*	✓	✓	—	IP40	3,6V/1,5Ah Ni-Cd	3 h	3,3W/3,7VA	105/105 lm	866 gr.
923131501	GR-1315/30L*	✓	✓	—	IP40	3,6V/1,5Ah Ni-Cd	1,5 h	4,5W/4,9VA	210/210 lm	866 gr.
923131601	GR-1316/30L*	✓	✓	—	IP40	3,6V/3Ah Ni-Cd	3 h	5,3W/5,6VA	210/210 lm	934 gr.
923131502	GR-1315/4P	✓	✓	—	IP40	4,8V/1,5Ah Ni-Cd	1,5 h	4,7W/5,1VA	175/350 lm	930 gr.
923131503	GR-1315/6P	✓	✓	—	IP40	4,8V/3Ah Ni-Cd	1,5 h	6,2W/6,5VA	245/480 lm	1020 gr.
923131602	GR-1316/4P	✓	✓	—	IP40	4,8V/3Ah Ni-Cd	3 h	5,3W/5,7VA	175/350 lm	1020 gr.
923131603	GR-1316/6P	✓	✓	—	IP40	4,8V/4Ah Ni-MH	3 h	6,2W/6,5VA	245/480 lm	1060 gr.
923131002	GR-1310/4P	✓	—	✓	IP40	4,8V/1,5Ah Ni-Cd	1,5 h	4,3W/4,7VA	350 lm	985 gr.
923131003	GR-1310/6P	—	—	✓	IP40	4,8V/3Ah Ni-Cd	1,5 h	3,5W/4VA	480 lm	1075 gr.
923131202	GR-1312/4P	—	—	✓	IP40	4,8V/3Ah Ni-Cd	3 h	4,6W/4,9VA	350 lm	1075 gr.
923131203	GR-1312/6P	—	—	✓	IP40	4,8V/4Ah Ni-MH	3 h	4,9W/5,2VA	480 lm	1125 gr.
923131004	GR-1310/12L/180	—	✓	✓	IP40	3,6V/1Ah Ni-Cd	3 h	2,9W/3,2VA	38/100 lm	845 gr.
923131005	GR-1310/12L/90	—	✓	✓	IP40	3,6V/600mAh Ni-Cd	1,5 h	2,9W/3,2VA	40/100 lm	835 gr.
923131000	GR-1310/15L*	—	✓	✓	IP40	3,6V/600mAh Ni-Cd	1,5 h	3,1W/3,3VA	30/105 lm	841 gr.
923131200	GR-1312/15L*	—	✓	✓	IP40	3,6V/1,5Ah Ni-Cd	3 h	3,4W/3,6VA	30/105 lm	918 gr.
923131001	GR-1310/30L*	—	✓	✓	IP40	3,6V/1,5Ah Ni-Cd	1,5 h	3,3W/3,5VA	30/210 lm	918 gr.
923131201	GR-1312/30L*	—	✓	✓	IP40	3,6V/3Ah Ni-Cd	3 h	4,5W/4,8VA	30/210 lm	990 gr.

The packaging contains 15pcs.  
\*They have BSI & CNBOP-PIB certifications

SINGLE-SIDE PICTOGRAMS				
CODE	TYPE	DESCRIPTION	INCLUDED	ON DEMAND
807131007	S-13100/LO	Pictogram Left ISO single side 26m	✓	
807131005	S-13100/RO	Pictogram Right ISO single side 26m	✓	
807131009	S-13100/DO	Pictogram Down ISO single side 26m	✓	
807131011	S-13100/UO	Pictogram Up ISO single side 26m		✓

ACCESSORIES				
CODE	TYPE	DESCRIPTION	ON DEMAND	
980330180	A-3018	Suspended ceiling mounting springs	✓	10,9 gr.
922116006	SP-116/RLDUB	Double sided Plexiglass 4mm marking panel with all directions (Can be used only when the luminaire is installed on the ceiling)	✓	434 gr.



A-3018



SP-116/RLDUB

BATTERIES		
CODE	TYPE	DESCRIPTION
601003606	A-926	Battery 3,6V/600mAh Ni-Cd
601213615	B-972/HT	Battery 3,6V/1,5Ah Ni-Cd
601214815	B-973/HT	Battery 4,8V/1,5Ah Ni-Cd
601233630	B-949/HT	Battery 3,6V/3Ah Ni-Cd
601214830	B-941/HT	Battery 4,8V/3Ah Ni-Cd
601134840	B-936/HT60SC	Battery 4,8V/4Ah Ni-Mh
601233610	A-931/HT	Battery 3,6V/1Ah Ni-Cd



# WEATHER LIGHT

The luminaires of the Weather Light family are Olympia Electronics' offering for an emergency lighting and signage system suitable for environmentally burdened spaces. The Weather Light luminaires are specially designed for use in industrial and commercial installations, as they offer increased protection against impacts and intrusion from foreign objects and moisture. Furthermore, for use in installations with low ambient temperatures or high Electromagnetic interference, there is a version available that uses supercapacitors as a power source, rather than conventional batteries.

The high luminous flux output versions 4P and 6P can be used in large rooms with high ceilings. Also, there are versions available with 90 minutes, 3 hours, or 8 hours autonomy.

The Weather Light family luminaires can be used as double-sided emergency exit signs with the use of plastic diffusers A-1017 or A-9100. Also, the A-9000 accessory enables the GR-9XX luminaires to be installed as single-sided emergency exit signs. The GR-19XX self-testing luminaires can be remotely tested via the magnetic card A-1900.



GR-19xx

<b>CE</b>	22m		IP65
			<b>ST</b> SELF TESTING
1,5-3h			

GR-9xx

<b>CE</b>	26m		IP65
			<b>ST</b> SELF TESTING
1,5-3h	IK08		



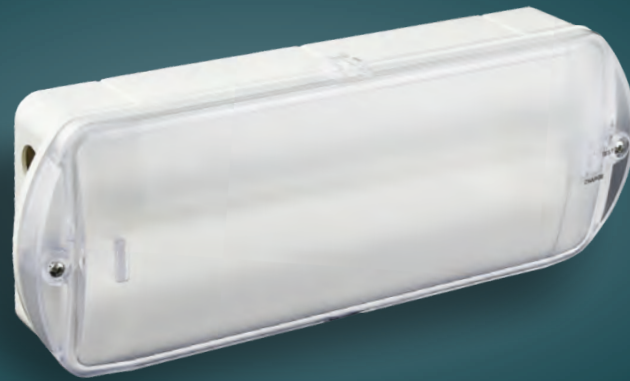

GR-19xx



KM640081  
BS EN 60598-2-22



\*They have BSI & CNBOP-PIB certifications

Mounting method

Wall mounting

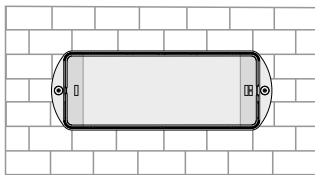

Dimensions

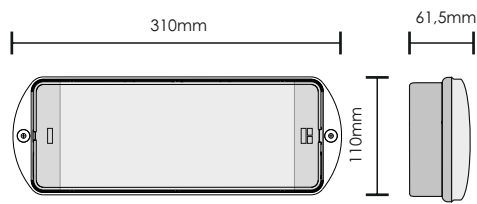

Photometric

GR-1935\_15L

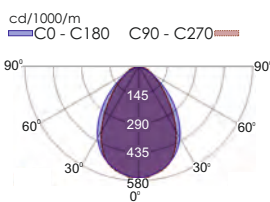

GR-1938-30L

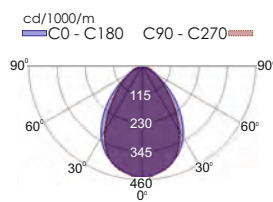

GR-1938-4P

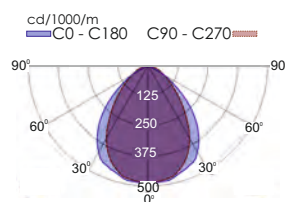

GR-1938-6P

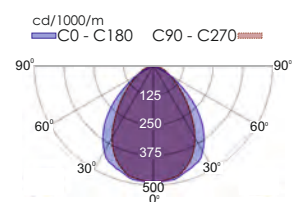

Internal selection - without L1	CODE	TYPE	ST	M	NM	☔	🔋	🕒	⚡	🏠 Mains/Emergency	📦 kg
		923193800	GR-1938/15L*	✓	✓	✓	IP65	3,6V/600mAh Ni-Cd	1,5 h	3,4W/3,8VA	105/105 lm
	923193801	GR-1938/30L*	✓	✓	✓	IP65	3,6V/1,5Ah Ni-Cd	1,5 h	4,5W/4,9VA	210/210 lm	811 gr.
	923193900	GR-1939/15L*	✓	✓	✓	IP65	3,6V/1,5Ah Ni-Cd	3 h	3,3W/3,7VA	105/105 lm	818 gr.
	923193901	GR-1939/30L*	✓	✓	✓	IP65	3,6V/3Ah Ni-Cd	3 h	5,3W/5,6VA	210/210 lm	890 gr.
	923193802	GR-1938/4P	✓	✓	✓	IP65	4,8V/1,5Ah Ni-Cd	1,5 h	4,7W/5,1VA	175/350 lm	865 gr.
	923193803	GR-1938/6P	✓	✓	✓	IP65	4,8V/3Ah Ni-Cd	1,5 h	6,2W/6,5VA	245/480 lm	950 gr.
	923193902	GR-1939/4P	✓	✓	✓	IP65	4,8V/3Ah Ni-Cd	3 h	5,3W/5,7VA	175/350 lm	950 gr.
	923193903	GR-1939/6P	✓	✓	✓	IP65	4,8V/4Ah Ni-Mh	3 h	6,2W/6,5VA	245/480 lm	1005 gr.
	923193500	GR-1935/15L*	—	✓	✓	IP65	3,6V/600mAh Ni-Cd	1,5 h	3,1W/3VA	40/105 lm	783 gr.
	923193501	GR-1935/30L*	—	✓	✓	IP65	3,6V/1,5Ah Ni-Cd	1,5 h	3,3W/3,5VA	40/210 lm	840 gr.
	923193600	GR-1936/15L*	—	✓	✓	IP65	3,6V/1,5Ah Ni-Cd	3 h	3,4W/3,6VA	40/105 lm	839 gr.
	923193601	GR-1936/30L*	—	✓	✓	IP65	3,6V/3Ah Ni-Cd	3 h	4,5W/4,8VA	40/210 lm	940 gr.

📦 The packaging contains 12pcs.

**SINGLE-SIDE PICTOGRAMS**

CODE	TYPE	DESCRIPTION	INCLUDED	ON DEMAND	
705693006	S-1938/LO	Pictogram Left ISO single side 22m	✓		←
705693008	S-1938/RO	Pictogram Right ISO single side 22m	✓		→
705693007	S-1938/DO	Pictogram Down ISO single side 22m	✓		↓
705690019	S-1938/UO	Pictogram Up ISO single side 22m		✓	↑

**ACCESSORIES**

CODE	TYPE	DESCRIPTION	📦 kg
927910000	A-9100/ST	Plastic double sided diffuser for self-testing	513,50 gr.
927910001	A-9100	Plastic double sided diffuser	513,50 gr.
927190000	A-1900	Magnetic test card	24,50 gr.



A-9100/ST  
A-9100



A-1900

**BATTERIES**

CODE	TYPE	DESCRIPTION
601003606	A-926	Battery 3,6V/600mAh Ni-Cd
601213615	B-972/HT	Battery 3,6V/1,5Ah HT Ni-Cd
601233630	B-949/HT	Battery 3,6V/3Ah HT Ni-Cd
601214815	B-973/HT	Battery 4,8V/1,5Ah HT Ni-Cd
601214830	B-941/HT	Battery 4,8V/3Ah HT Ni-Cd
601134840	B-936/HT60SC	Battery 4,8V/4Ah Ni-Mh



GR-9xx

Mounting method

Wall mounting

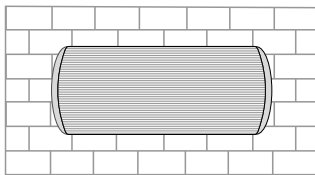

Dimensions

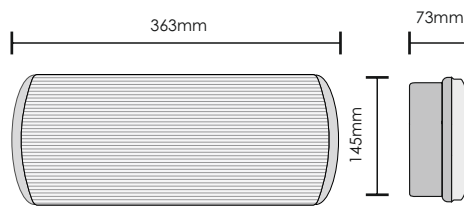

Photometric

GR-935-4P, GR-935-6P,  
GR-936-4P, GR-936-6P

cd/1000/m

C0 - C180 C90 - C270

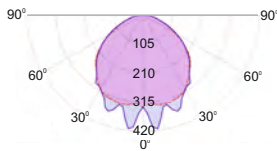

GR-940-15L, GR-935-15L, GR-935/30L,  
GR-936-15L, GR-936-30L, GR-941-15L

cd/1000/m

C0 - C180 C90 - C270

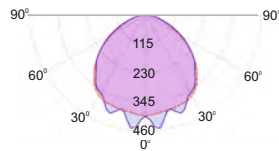

CODE	TYPE	ST	M	NM						
923940000	GR-940/15L	✓	✓	✓	IP65	3,6V/3Ah Ni-Cd	8 h	4,1W/4,5VA	105/105 lm	1135 gr.
923935013	GR-935/15L	—	—	✓	IP65	3,6V/600mAh Ni-Cd	1,5 h	2,5W/3VA	125 lm	1006 gr.
923935014	GR-935/30L	—	—	✓	IP65	3,6V/1,5Ah Ni-Cd	1,5 h	2,5W/3VA	250 lm	1082 gr.
923936009	GR-936/15L	—	—	✓	IP65	3,6V/1,5Ah Ni-Cd	3 h	2,5W/3VA	125 lm	1076 gr.
923936010	GR-936/30L	—	—	✓	IP65	3,6V/3Ah Ni-Cd	3 h	3,6W/4,3VA	250 lm	1175 gr.
923935010	GR-935/4P	—	—	✓	IP65	4,8V/1,5Ah Ni-Cd	1,5 h	4VA	350 lm	1142 gr.
923935011	GR-935/6P	—	—	✓	IP65	4,8V/3Ah Ni-Cd	1,5 h	4,8VA	480 lm	1250 gr.
923936005	GR-936/4P	—	—	✓	IP65	4,8V/3Ah Ni-Cd	3 h	4,8VA	350 lm	1230 gr.
923936006	GR-936/6P	—	—	✓	IP65	4,8V/4Ah Ni-Mh	3 h	5,5VA	480 lm	1300 gr.
923941000	GR-941/15L	—	—	✓	IP65	3,6V/3Ah Ni-Cd	8 h	3,5W/4VA	105 lm	1175 gr.

The packaging contains 12pcs.

SINGLE-SIDE PICTOGRAMS				
CODE	TYPE	DESCRIPTION	INCLUDED	ON DEMAND
705690016	S-93593/LO	Pictogram Left ISO single side 26m	✓	
705690017	S-93593/RO	Pictogram Right ISO single side 26m	✓	
705690018	S-93593/DO	Pictogram Down ISO single side 26m	✓	
705690019	S-93593/UO	Pictogram Up ISO single side 26m		✓

SINGLE-SIDE PICTOGRAMS FOR A-1017 DIFFUSER				
CODE	DESCRIPTION	INCLUDED	ON DEMAND	
705693003	Pictogram Left ISO single side 26m	✓		
705693004	Pictogram Right ISO single side 26m	✓		
705693005	Pictogram Down ISO single side 26m	✓		
705693002	Pictogram Up ISO single side 26m		✓	

ACCESSORIES			
CODE	TYPE	DESCRIPTION	
927101700	A-1017	Plastic double sided diffuser	538 gr.
927900001	A-9000	Ceiling bracket for GR-9xx/xxL	879 gr.



A-1017

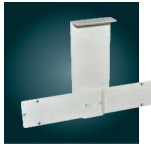

A-9000

BATTERIES		
CODE	TYPE	DESCRIPTION
601003606	A-926	Battery 3,6V/600mAh Ni-Cd
601213615	B-972/HT	Battery 3,6V/1,5Ah HT Ni-Cd
601233630	B-949/HT	Battery 3,6V/3Ah HT Ni-Cd
601214815	B-973/HT	Battery 4,8V/1,5Ah HT Ni-Cd
601214830	B-941/HT	Battery 4,8V/3Ah HT Ni-Cd
601134840	B-936/HT60SC	Battery 4,8V/4Ah Ni-Mh

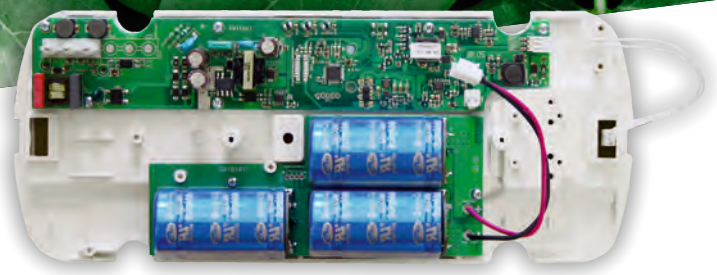

### Mounting method

---

#### Wall mounting

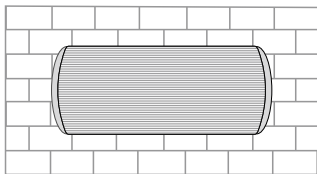

### Dimensions

---

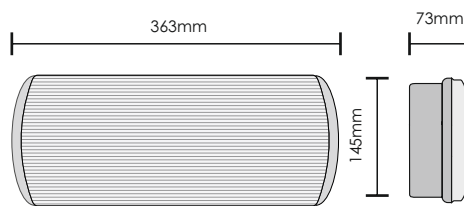

### Photometric

---

GR-900/30L/SC

cd/1000/m

— C0 - C180    C90 - C270

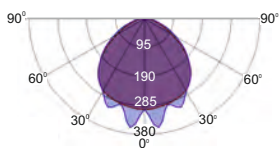

# WEATHER LIGHT



innovation  
without  
batteries



years  
guarantee



CODE	TYPE	ST	M	NM	Water	Battery	Light	Power	Mains/Emergency	Weight
923900000	GR-900/30L/SC	✓	✓	—	IP65	Supercapacitor	1h	6W/6.5VA/PF:0.92	250/90lm	1247 gr.

Using supercapacitors as energy storage media in place of conventional batteries is the most modern and sophisticated solution in emergency luminaires. Designed for, at of reliable function with much higher number of charging / least, 10 years discharging cycles. It can withstand extreme temperatures such as -40 ° C and +65 ° C without serious degradation of it's specifications.

Comparing table of the supercapacitor, Ni-CD and Ni-MH batteries	Supercapacitor	Ni-Cd battery	Ni-MH battery
Designed for	>10 years	4 years	4 years
Number of charging / discharging cycles	>500.000	500 - 2000	300 - 1500
Suitable ambient temperature	-40°C +65°C	0° +55°C	5° - 55C

GR-900/30L/SC has advanced microprocessor based circuits for all functioning blocks and sophisticated charging/discharging method that's targeting supercapacitor's longer life.

Specifications for the new supercapacitor self-testing luminaire

- The GR-900/30L/SC has a power pack consisting of super capacitors and not conventional batteries.
- It has a total guarantee of 10 years.
- It is self-testing with advanced circuits for charging and discharging the capacitors.
- It has low consumption and a high Power Factor 0.93.

## SINGLE-SIDE PICTOGRAMS

CODE	TYPE	DESCRIPTION	INCLUDED	ON DEMAND	Pictogram
705690016	S-93593/LO	Pictogram Left ISO single side 26m	✓		←
705690017	S-93593/RO	Pictogram Right ISO single side 26m	✓		→
705690018	S-93593/DO	Pictogram Down ISO single side 26m	✓		↓
705690019	S-93593/UO	Pictogram Up ISO single side 26m		✓	↑

## SINGLE-SIDE PICTOGRAMS FOR A-1017 DIFFUSER

CODE	DESCRIPTION	INCLUDED	ON DEMAND	Pictogram
705693003	Pictogram Left ISO single side 26m	✓		←
705693004	Pictogram Right ISO single side 26m	✓		→
705693005	Pictogram Down ISO single side 26m	✓		↓
705693002	Pictogram Up ISO single side 26m		✓	↑

## ACCESSORIES

CODE	TYPE	DESCRIPTION	Weight
927101700	A-1017	Plastic double sided diffuser	538 gr.
927900001	A-9000	Ceiling bracket for GR-9xx/xxL	879 gr.



A-1017



A-9000



# OLYMPUS LED

The Olympus series is the latest offering from Olympia Electronics for an emergency luminaire family suitable to cover multiple demands with low cost and modern design. The Olympus emergency luminaires are specially designed to cover emergency lighting specifications for small to medium-sized installations. The low profile and the ability for recessed mounting in false ceilings make them suitable for installation in hotels. For use in environmentally burdened areas, the luminaires of the Olympus series are available in IP65 ingress protection rating. Additionally, there is the LT version, suitable for use in low temperatures.

The self-testing versions of the Olympus family offer the option to set the autonomy of each luminaire to 1, 3, or 8 hours, via internal switches. Furthermore, the internal design provisions for different power sources such as Supercapacitors or LiFePO4 batteries, additionally to the standard Ni-Cd batteries.

The Olympus series of emergency luminaires have three basic versions. Specifically:

OLY-500: low-cost version with test button suitable for use as an emergency exit sign in residential and commercial installations with an autonomy of 3 hours.

OLY-1004: suitable as an emergency light and emergency exit sign for small to medium-sized installations, with the ability to set the desired autonomy via internal dip switches.

OLY-1024: version with asymmetric optics suitable as an emergency luminaire for illuminating exit routes.

The Olympus series of emergency luminaires can be used as double-sided emergency exit signs with the use of the SP-1100/XX exit signs.



OLY-500/1004  
OLY-1024

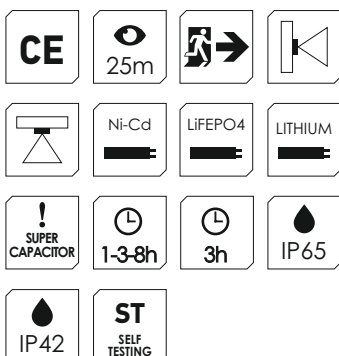





1  
OLY-500/1004



2  
OLY-1024  
For escape routes

Mounting method

Ceiling or wall mounting

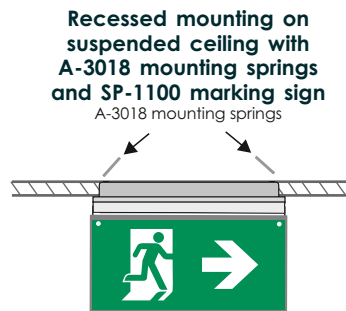
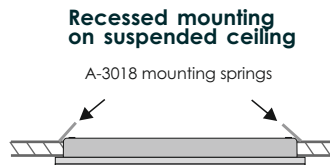
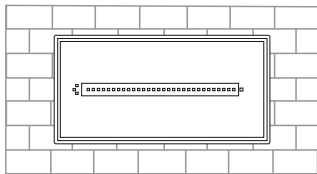

Dimensions

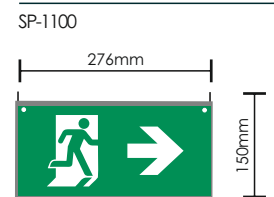

Dimensions

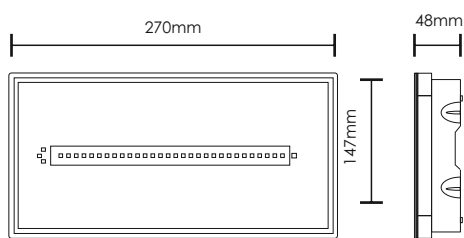

Photometric

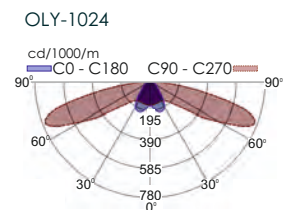
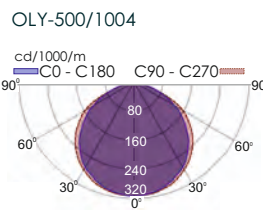

Required opening for suspended wall or ceiling installation

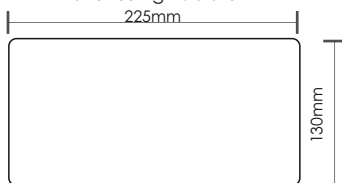

CODE	TYPE	IMAGE	ST	M	NM							
										1h	3h	8h
923500000	OLY-500	1	—	✓	✓	IP42	3,6V/1Ah Ni-Cd	3 h	3,4W/3,6VA	38/100 lm	822 gr.	
923500001	OLY-500/WP	1	—	✓	✓	IP65	3,6V/1Ah Ni-Cd	3 h	3,4W/3,6VA	38/100 lm	822 gr.	
923100403	OLY-1004	1	✓	✓	✓	IP42	3,6V/3Ah Ni-Cd	1h/3h/8h	4,5W/4,7VA	300/350 300/295 300/95lm	945 gr.	
923102403	OLY-1024	2	✓	✓	✓	IP42	3,6V/3Ah Ni-Cd	1h/3h/8h	4,6W/4,8VA	300/380 300/320 300/100lm	940 gr.	
923100400	OLY-1004/WP	1	✓	✓	✓	IP65	3,6V/3Ah Ni-Cd	1h/3h/8h	4,5W/4,7VA	300/350 300/295 300/95lm	945 gr.	
923102400	OLY-1024/WP	2	✓	✓	✓	IP65	3,6V/3Ah Ni-Cd	1h/3h/8h	4,6W/4,8VA	300/380 300/320 300/100lm	940 gr.	
923100410	OLY-1004/LT/WP*	1	✓	✓	✓	IP65	4,8V/2Ah LTO	1h/3h/8h	5,2W/5,4VA	300/350 300/190 300/50lm	863 gr.	
923100411	OLY-1004/LF/WP	1	✓	✓	✓	IP65	3,2V/2Ah LF	1h/3h/8h	4,8W/5VA	300/350 300/190 300/50lm	802 gr.	
923100412	OLY-1004/SC/WP	1	✓	✓	✓	IP65	Supercapacitor	-	5,3W/5,5VA	300/320 300/120 300/30lm	875 gr.	

\* For low temperature -25°-40°

The packaging contains 10pcs.

SINGLE-SIDE PICTOGRAMS				
CODE	TYPE	DESCRIPTION	INCLUDED	ON DEMAND
804011001	SW-110X/LO	Pictogram Left ISO single side 25m	✓	
804011000	SW-110X/RO	Pictogram Right ISO single side 25m	✓	
804011002	SW-110X/DRO	Pictogram Down ISO single side 25m	✓	
804011003	SW-110X/UO	Pictogram Up ISO single side 25m		✓

ACCESSORIES			
CODE	TYPE	DESCRIPTION	
980330180	A-3018	Suspended ceiling mounting springs	10,9 gr.
922110005	SP-1100/RLDUB	Double sided Plexiglass 6mm marking panel for all directions	454 gr.

BATTERIES		
CODE	TYPE	DESCRIPTION
601233610	A-931/HT	Battery 3,6V/1Ah HT NiCd
601233630	B-949/HT	Battery 3,6V/3Ah Ni-Cd
601404820	B-925/HT	Battery 4,8V/2Ah LTO Lithium Titanium
601303220	A-918/HT	Battery 3,2V/2Ah LiFePO4



# BAU LIGHT



1 GR-751/LP/LL  
GR-753/LP/HL

2 GR-750/HP/LL  
GR-752/HP/HL



CODE	TYPE	IMAGE	ST	M	NM	IP	Battery	Time	Power	Mains/Emergency	kg
923750001	GR-750/ST/HP/LL	2	✓	✓	✓	IP54	3,6V/1,5Ah Ni-Cd	1h/3h/8h	4,1W/4,3VA	270/300 270/150 270/30lm	937 gr.
923751000	GR-751/ST/LP/LL	1	✓	✓	✓	IP54	3,6V/1,5Ah Ni-Cd	1h/3h/8h	4,1W/4,3VA	270/300 270/150 270/30lm	888 gr.
923752000	GR-752/ST/HP/HL	2	✓	✓	✓	IP54	3,6V/3Ah Ni-Cd	1h/3h/8h	4,5W/4,7VA	270/350 270/280 270/90lm	1010 gr.
923753000	GR-753/ST/LP/HL	1	✓	✓	✓	IP54	3,6V/3Ah Ni-Cd	1h/3h/8h	4,5W/4,7VA	270/350 270/280 270/90lm	961 gr.

HP: High Profile/ High opal hood, LP: Low Profile /deep transparent hood, LL: Low luminosity/small light intensity HL: High luminosity/Great light intensity

The packaging contains 9pcs.

SINGLE-SIDE PICTOGRAMS					
CODE	TYPE	DESCRIPTION	IMAGE	INCLUDED	
807750006	S-75000/LO	Pictogram Left ISO single side 17m	1	✓	
807750004	S-75000/RO	Pictogram Right ISO single side 17m	1	✓	
807750008	S-75000/DO	Pictogram Down ISO single side 17m	1	✓	
807730006	S-73600/LO	Pictogram Left ISO single side 15m	2	✓	
807730004	S-73600/RO	Pictogram Right ISO single side 15m	2	✓	
807730008	S-73600/DO	Pictogram Down ISO single side 15m	2	✓	
807736006	S-73601/LO	Pictogram Left ISO single side 15m	2	✓	
807736004	S-73601/RO	Pictogram Right ISO single side 15m	2	✓	
807736008	S-73601/DO	Pictogram Down ISO single side 15m	2	✓	

BATTERIES		
CODE	TYPE	DESCRIPTION
601213615	B-972/HT	Battery 3,6V/1,5Ah NiCd
601233630	B-949/HT	Battery 3,6V/3Ah Ni-Cd

## Mounting methods

### Ceiling or wall mounting

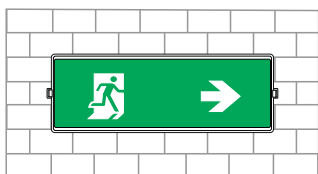

## Dimensions

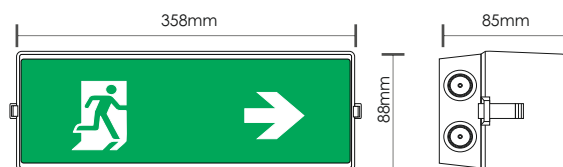

LP: Low Profile /deep transparent hood

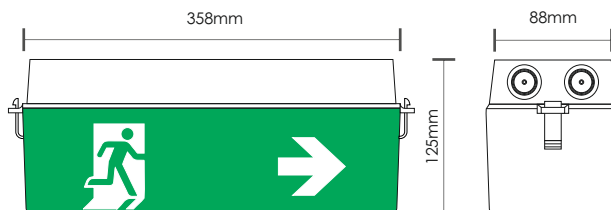

HP: High Profile/ High opal hood

## Photometric

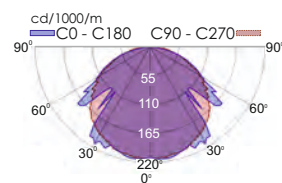



Small text label on the wall.

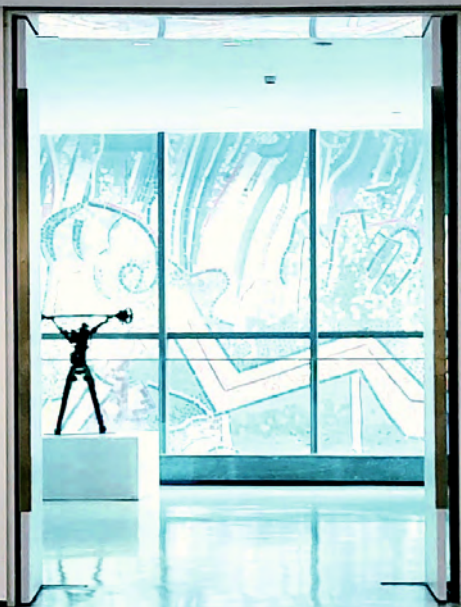

# LINEAR LIGHT



\*They have BSI certification



CODE	TYPE	ST	M	NM	IP	Battery	Runtime	Power	Mains/Emergency	Weight
922502057	KLIN-20/ST*	✓	✓	✓	IP54	3,6V/1,2Ah Ni-Mh	1-3-8 h	3,9W/4,4VA	80/250 80/77 80/12 lm	405 gr.

## ACCESSORIES ON DEMAND

CODE	TYPE	DESCRIPTION	Weight
927321300	A-2130	Set of accessories (1m) for ceiling mounting (white)	375 gr.
927321310	A-2131	Set of accessories (0,5m) for ceiling mounting (white)	280 gr.
927321320	A-2132	Set of accessories (0,25m) for ceiling mounting (white)	139 gr.
927321330	A-2133	Accessory for vertical wall mounting (white)	108 gr.
927321360	A-2136	Accessory set for ceiling mounted hanging installations with 2,5m cable	164 gr.
927252000	A-2520/PL/ST	Suspended ceiling base for self-testing luminaire KLD-xx	195 gr.



A-2130, A-2131, A-2132

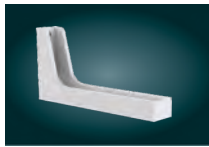

A-2133

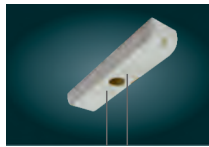

A-2136



A-2520/PL/ST

## BATTERIES

CODE	TYPE	DESCRIPTION
601103612	A-965/HT	Battery 3,6V/1,2Ah Ni-Mh

## Mounting method

### Wall mounting

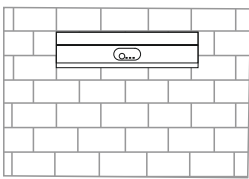

### Ceiling mounting



### Ceiling mounting with extension rod

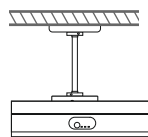

### Vertical wall mounting

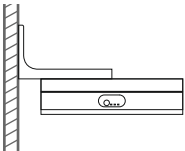

### Ceiling hanging installation with cable

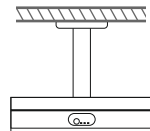

## Dimensions

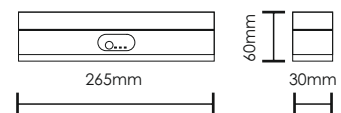

## Photometric

### KLIN-20/ST

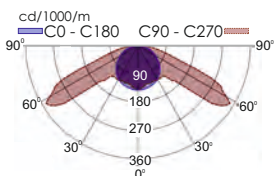









# ECO LIGHT

The EcoLight family of luminaires is designed with style, reliability and easy installation in mind. They are luminaires in different housing with a large number of low power and long life LEDs which guarantee uniform lighting of the sign. They are ideal for installation in office and cinema buildings, hotels, shopping malls, cafes and restaurant environments. The luminaires of this family are designed to cover long viewing distances and they can be easily mounted on the ceiling, parallel to the wall, hung with wire or recessed in the ceiling with the appropriate accessories.

The family is divided into 5 major categories, specifically:

**1. The series of luminaires ZLD-XX**, which are made of an elegant aluminum profile and are used only for marking for 16, 30 or 38 meters. The luminaires have been certified by the Polish Science and Research Center (CNBOP) and the British Standards Institution (BSI). They are self-testing luminaires, with continuous / non-continuous operation with an autonomy of 3 hours.

They can also be easily mounted on the wall and ceiling, through various mounting accessories:

- Recessed with bases A-1018/PL ST & A-1020/PL/ST
- Hanging ceiling mounted with accessories A-1130, A-1131, A-1132 for 1m, 0.5m and 0.25m respectively.
- Vertical to the wall with base A-1133 (only for ZLD-28 / EM & ZLD-34/EM)
- Wall mounted with accessory A-1134

**2. The series of luminaires MLD-XX**, which are designed in a thin plastic profile with a special style are used only for marking 16, 30 or 38 meters. The series is divided into 2 categories: MLD-XX /w with white LEDs and MLD-XX with green LEDs. The category of luminaires MLD-XX / w has received a certificate from the Scientific and Research Center of Poland (CNBOP) and from the Institute of British Standards (BSI). They are self-testing luminaires, continuous / non-continuous operation with an autonomy of 3 hours.

**3. The CLD-30 luminaires** which are designed in a unique cylindrical profile aluminum are used only for marking for 30 meters. They are self-testing luminaires of continuous / non-continuous operation with autonomy of 3 hours, while there is also the CLD-30 / NST version in the same series which are non-self testing

The luminaires can be easily mounted on the wall and ceiling, through various mounting accessories:

- Hanging ceiling mounted with accessories A-1130, A-1131, A-1132 for 1m, 0.5m and 0.25m respectively.
- Vertical to the wall with the base A-1133
- Wall mounted with accessory A-1134

**4. The luminaires PLD-25/NiMH/M** which are designed in a minimalist plastic profile, are easily connected and installed with a viewing distance of 26 meters. They are self testing luminaires of continuous / non-continuous operation with autonomy of 3 hours, while there is the PLD-25/NST version which are non-self testing. In addition there is a version with supercapacitors, the PLD-25/SC, with an autonomy of 1 hour and a temperature range from -40 °C to 65 °C and a of good operation guarantee of 10 years for the entire luminaire.

The luminaires can be easily mounted on the wall and ceiling, through various mounting accessories:

- Hanging ceiling mounted with accessories A-2130, A-2131, A-2132 for 1m, 0.5m and 0.25m respectively.
- Vertical to the wall with the base A-2133
- Recessed in suspended ceiling with bases A-2510 / PL and A-2510 / PL / ST / M

**5. The KLR, KLD series** are modern luminaires with a linear style and a flexible base which make them able to be installed with great ease on walls and ceilings. The luminaires of this series are of continuous / non-continuous operation, self-testing and non-self-testing, with different viewing distances. The self-testing versions have the capability of autonomy adjustment via switches with a choice between 1, 3 or 8 hours while the non-self testing versions are set to 3 hours autonomy.

This series is divided as follows:

- KLR-20 with a viewing distance of 20 meters
- KLD-22 with a viewing distance of 22 meters
- KLD-30 with a viewing distance of 30 meters

All luminaires can be mounted on walls and ceilings with various mounting accessories:

Recessed with bases A-2520 / PL / ST & A-2520 / PL (Only for KLD-XX)

- Hanging ceiling mounted with accessories A-2130, A-2131, A-2132 for 1m, 0.5m and 0.25m respectively.
- Vertical to the wall with the base A-2133
- Wall mounted on wall with accessory A-2138 (Included in the package)
- Ceiling mounted with accessory A-2137 (Included in the package)
- Suspended ceiling mounting with 2.5m cable with component A-2136



1

MLD-34X/x  
MLD-44X/x



2

MLD-28X/x

# ECO LIGHT



\*They have BSI & CNBOP-PIB certifications

3h	IP40	CE		16m
30m	38m	Ni-Cd		

## Mounting method



## Dimensions

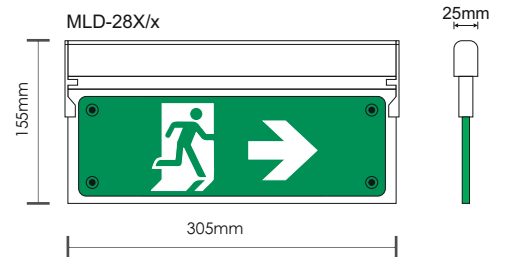
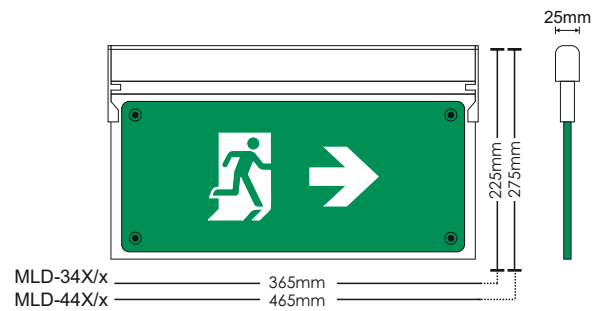

CODE	TYPE	ST	M	NM						kg
922502811	MLD-28D/w*	—	✓	✓	IP40	3,6V/1Ah Ni-Cd	3 h	3W/7,5VA	85/85 lm	705 gr.
922503426	MLD-34D/w*	—	✓	✓	IP40	3,6V/1Ah Ni-Cd	3 h	3W/8VA	105/85 lm	1135 gr.
922504417	MLD-44D/w*	—	✓	✓	IP40	3,6V/1Ah Ni-Cd	3 h	3W/8VA	105/85lm	1679 gr.
922502800	MLD-28S/g	—	✓	—	IP40	3,6V/1Ah Ni-Cd	3 h	3W/7,5VA	18/18 lm	685 gr.
922503400	MLD-34S/g	—	✓	—	IP40	3,6V/1Ah Ni-Cd	3 h	3W/8VA	22/18 lm	1020 gr.
922504400	MLD-44S/g	—	✓	—	IP40	3,6V/1Ah Ni-Cd	3 h	3W/8VA	22/18 lm	1531 gr.

The packaging contains 20pcs. of MLD-X/x, 10pcs. of MLD-34X/x, 10pcs. of MLD-44X/x

SINGLE-SIDE PICTOGRAMS				
CODE	TYPE	DESCRIPTION	INCLUDED	ON DEMAND
804012228	SW-28/L	PVC transparent 0,5mm for MLD-28 16m	✓	
804012028	SW-28/R	PVC transparent 0,5mm for MLD-28 16m	✓	
804012128	SW-28/DR	PVC transparent 0,5mm for MLD-28 16m		
804012328	SW-28/DL	PVC transparent 0,5mm for MLD-28 16m		
804012428	SW-28/UR	PVC transparent 0,5mm for MLD-28 16m		
804012429	SW-28/UL	PVC transparent 0,5mm for MLD-28 16m		
804012534	SW-34/L	PVC transparent 0,5mm for MLD-34 30m	✓	
804012034	SW-34/R	PVC transparent 0,5mm for MLD-34 30m	✓	
804012134	SW-34/DR	PVC transparent 0,5mm for MLD-34 30m		
804012634	SW-34/DL	PVC transparent 0,5mm for MLD-34 30m		
804012234	SW-34/UR	PVC transparent 0,5mm for MLD-34 30m		
804012235	SW-34/UL	PVC transparent 0,5mm for MLD-34 30m		
804013544	SW-44/L	PVC transparent 0,5mm for MLD-44 38m	✓	
804013444	SW-44/R	PVC transparent 0,5mm for MLD-44 38m	✓	
804014444	SW-44/DR	PVC transparent 0,5mm for MLD-44 38m		
804014544	SW-44/DL	PVC transparent 0,5mm for MLD-44 38m		
804012444	SW-44/UR	PVC transparent 0,5mm for MLD-44 38m		
804012445	SW-44/UL	PVC transparent 0,5mm for MLD-44 38m		

ACCESSORIES				
CODE	TYPE	DESCRIPTION	INCLUDED	ON DEMAND
927101801	A-1018/PL	Recess mounting base for MLD-28		✓
927102001	A-1020/PL	Recess mounting base for MLD-34		✓



A-1018/PL

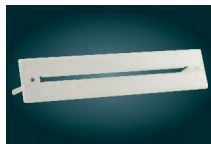

A-1020/PL

BATTERIES		
CODE	TYPE	DESCRIPTION
601223610	A-938/HT	Battery 3,6V/1Ah Ni-Cd



# ECO LIGHT



KM640081  
BS EN 60598-2-22

\*They have BSI & CNBOP-PIB certifications



## Mounting method

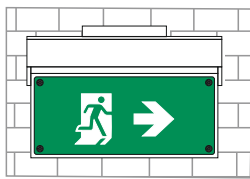

Ceiling mounting  
with extension rod 0,25-1m

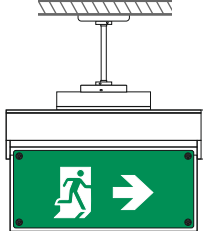

Ceiling mounting



Recessed ceiling mounting  
on suspended ceiling  
with mounting base

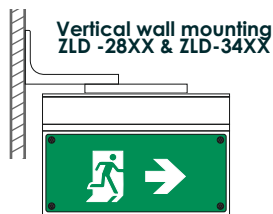

Vertical wall mounting  
ZLD -28XX & ZLD-34XX

## Dimensions

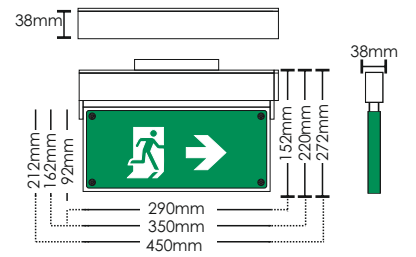

CODE	TYPE	ST	M	NM						kg
922502858	ZLD-28/EM*	✓	✓	—	IP40	3,6V/1,5Ah Ni-Mh	3 h	3,8W/6,5VA	125/125 lm	1021 gr.
922503462	ZLD-34/EM*	✓	✓	—	IP40	3,6V/1,5Ah Ni-Mh	3 h	4W/6,7VA	145/125 lm	1401 gr.
922504456	ZLD-44/EM	✓	✓	—	IP40	3,6V/1,5Ah Ni-Mh	3 h	4,3W/6,9VA	170/125 lm	1936 gr.

SINGLE-SIDE PICTOGRAMS				
CODE	TYPE	DESCRIPTION	INCLUDED	ON DEMAND
804012228	SW-28/L	PVC transparent 0,5mm for ZLD-28 16m	✓	
804012028	SW-28/R	PVC transparent 0,5mm for ZLD-28 16m	✓	
804012128	SW-28/DR	PVC transparent 0,5mm for ZLD-28 16m		✓
804012328	SW-28/DL	PVC transparent 0,5mm for ZLD-28 16m		✓
804012428	SW-28/UR	PVC transparent 0,5mm for ZLD-28 16m		✓
804012429	SW-28/UL	PVC transparent 0,5mm for ZLD-28 16m		✓
804012534	SW-34/L	PVC transparent 0,5mm for ZLD-34 30m	✓	
804012034	SW-34/R	PVC transparent 0,5mm for ZLD-34 30m	✓	
804012134	SW-34/DR	PVC transparent 0,5mm for ZLD-34 30m		✓
804012634	SW-34/DL	PVC transparent 0,5mm for ZLD-34 30m		✓
804012234	SW-34/UR	PVC transparent 0,5mm for ZLD-34 30m		✓
804012235	SW-34/UL	PVC transparent 0,5mm for ZLD-34 30m		✓
804013544	SW-44/L	PVC transparent 0,5mm for ZLD-44 38m	✓	
804013444	SW-44/R	PVC transparent 0,5mm for ZLD-44 38m	✓	
804014444	SW-44/DR	PVC transparent 0,5mm for ZLD-44 38m		✓
804014544	SW-44/DL	PVC transparent 0,5mm for ZLD-44 38m		✓
804012444	SW-44/UR	PVC transparent 0,5mm for ZLD-44 38m		✓
804012445	SW-44/UL	PVC transparent 0,5mm for ZLD-44 38m		✓

ACCESSORIES					
CODE	TYPE	DESCRIPTION	INCLUDED	ON DEMAND	kg
927101802	A-1018/PL/ST	Recess mounting base for self-testing luminaries		✓	165 gr.
927102002	A-1020/PL/ST	Recess mounting base for self-testing luminaries		✓	195 gr.
927311300	A-1130	Set of accessories (1m) for ceiling mounting (silver)		✓	375 gr.
927311310	A-1131	Set of accessories (0,5m) for ceiling mounting (silver)		✓	280 gr.
927311320	A-1132	Set of accessories (0,25m) for ceiling mounting (silver)		✓	139 gr.
927311330	A-1133	Accessory for vertical wall mounting (silver) (Only for ZLD 28/34 EM)		✓	106,5 gr
927311340	A-1134	Accessory for wall mounting (silver)	✓		111 gr.



A-1018/PL/ST  
A-1020/PL/ST



A-1130, A-1131,  
A-1132

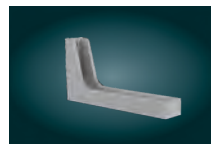

A-1133



A-1134

BATTERIES		
CODE	TYPE	DESCRIPTION
601103612	A-965/HT	Battery 3,6V/1,5Ah Ni-Mh



# ECO LIGHT



CODE	TYPE	ST	M	NM	IP	Battery	Runtime	Power	Mains/Emergency	kg
922503000	CLD-30	✓	✓	—	IP40	3,6V/1,5Ah Ni-MH	3 h	2,7W/3VA	63 / 125 lm	1350 gr.
922503001	CLD-30/NST	—	✓	—	IP40	3,6V/1Ah Ni-Cd	3 h	3,5W/3,7VA	45 / 95 lm	1323 gr.

SINGLE-SIDE PICTOGRAMS			INCLUDED	ON DEMAND	
CODE	TYPE	DESCRIPTION			
804030031	SW-30/L	Marking overlay with left indication 30m	✓		
804030030	SW-30/R	Marking overlay with right indication 30m	✓		
804030033	SW-30/DL	Marking overlay with down left indication 30m		✓	
804030032	SW-30/DR	Marking overlay with down right indication 30m		✓	

CODE	TYPE	DESCRIPTION	INCLUDED	ON DEMAND	kg
927311300	A-1130	Set of accessories (1m) for ceiling mounting (silver)		✓	375 gr.
927311310	A-1131	Set of accessories (0,5m) for ceiling mounting (silver)		✓	280 gr.
927311320	A-1132	Set of accessories (0,25m) for ceiling mounting (silver)		✓	139 gr.
927311330	A-1133	Accessory for vertical wall mounting (silver)		✓	106,5 gr
927311340	A-1134	Accessory for wall mounting (silver)	✓		111 gr.



A-1130, A-1131, A-1132

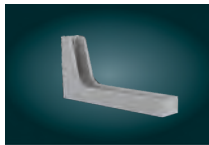

A-1133



A-1134

BATTERIES		
CODE	TYPE	DESCRIPTION
601103612	A-965/HT	Battery 3,6V/1,2Ah Ni-Mh
601223610	A-938/HT	Battery 3,6V/1Ah Ni-Cd

## Mounting method



Ceiling mounting with extension rod 0,25-1m

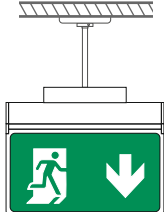

## Dimensions

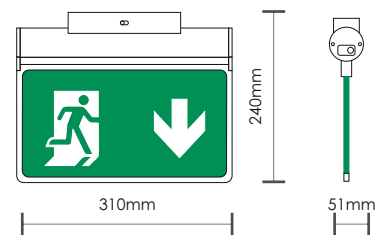





Mounting method



Dimensions

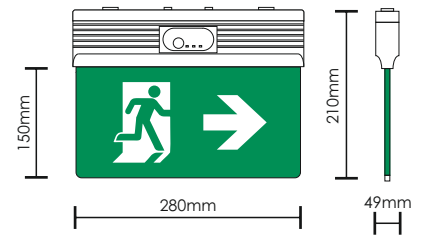

Required opening for suspended wall or ceiling installation

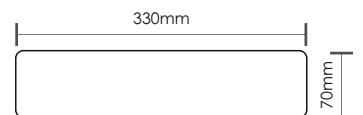

CODE	TYPE	ST	M	NM	IP	Battery	Time	Power	Mains/Emergency	kg
922502513	PLD-25/NiMH	✓	✓	—	IP44	3,6V/1,2Ah Ni-Mh	3 h	4W/4,4 VA	90/100 lm	1073 gr.
922502503	PLD-25/NST	—	✓	✓	IP44	3,6V/1,5Ah Ni-Mh	3 h	4,3W/4,6 VA	90/100 lm	1068 gr.
922502501	PLD-25/SC	✓	✓	—	IP44	Supercapacitor	1 h	4,3W/4,7VA	73/20 lm	1088 gr.

**SINGLE-SIDE PICTOGRAMS**

CODE	TYPE	DESCRIPTION	INCLUDED	ON DEMAND	Pictograms
804010125	SW-25/L	Marking overlay with left indication 26m	✓		←
804010025	SW-25/R	Marking overlay with right indication 26m	✓		→
804010325	SW-25/DL	Marking overlay with down left indication 26m		✓	↓
804010225	SW-25/DR	Marking overlay with down right indication 26m		✓	↘
804010525	SW-25/UL	Marking overlay with up left indication 26m		✓	↖
804010425	SW-25/UR	Marking overlay with up right indication 26m		✓	↗

**ACCESSORIES ON DEMAND**

CODE	TYPE	DESCRIPTION	kg
927251001	A-2510/PL	Suspended mounting base for luminaires without Autotest	169 gr.
927251002	A-2510/PL/ST/M	Suspended mounting base for Self-testing luminaires	181 gr.
927321300	A-2130	Set of accessories (1m) for ceiling mounting (white)	375 gr.
927321310	A-2131	Set of accessories (0,5m) for ceiling mounting (white)	280 gr.
927321320	A-2132	Set of accessories (0,25m) for ceiling mounting (white)	139 gr.
927321330	A-2133	Accessory for vertical wall mounting (white)	108 gr.

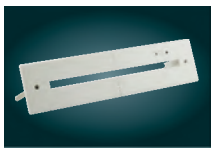

A-2510/PL

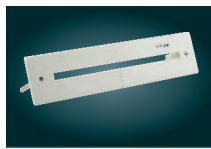

A-2510/PL/ST/M



A-2130, A-2131, A-2132

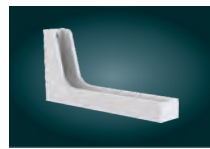

A-2133

**BATTERIES**

CODE	TYPE	DESCRIPTION
601103612	A-965/HT	Battery 3,6V/1,2Ah Ni-Mh
601103612	A-965/HT	Battery 3,6V/1,5Ah Ni-Mh

**10**  
years  
guarantee

**Innovation!**

The PLD-25/SC has one super capacitor instead of normal batteries and offers a 10 year guarantee for the good operation of the entire device. They are self-testing with advance capacitor charging and discharging circuits while simultaneously achieving low power consumption. Ambient operating temperature -40° +65°.

**!**  
innovation  
without  
batteries

Using supercapacitors as energy storage media in place of conventional batteries is the most modern and sophisticated solution in emergency luminaires. Designed for, at least, 10 years of reliable function with much higher number of charging /discharging cycles. It can withstand extreme temperatures like as -40°C and 65°C without seriously degradation of it's specifications.



Comparing table	Supercapacitor	Ni-Cd battery	Ni-MH battery
Designed for	>10 years	4 years	4 years
Number of charging / discharging cycles	>500.000	500 - 2000	300 - 1500
Working temperature range	-40 C <sup>o</sup> - 65C <sup>o</sup>	0 - 55C <sup>o</sup>	5 - 55C <sup>o</sup>



Mounting method for KLD-22 & KLD-30

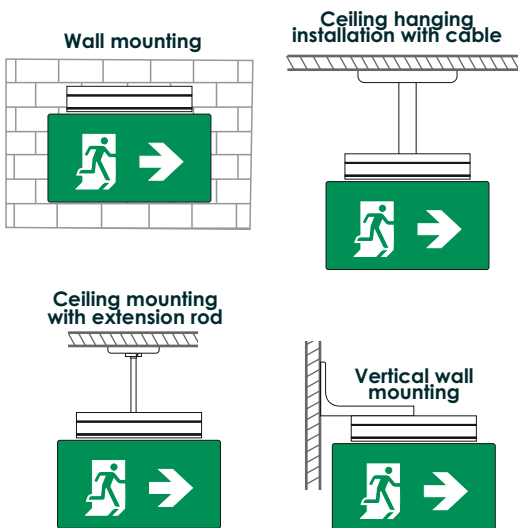

Dimensions

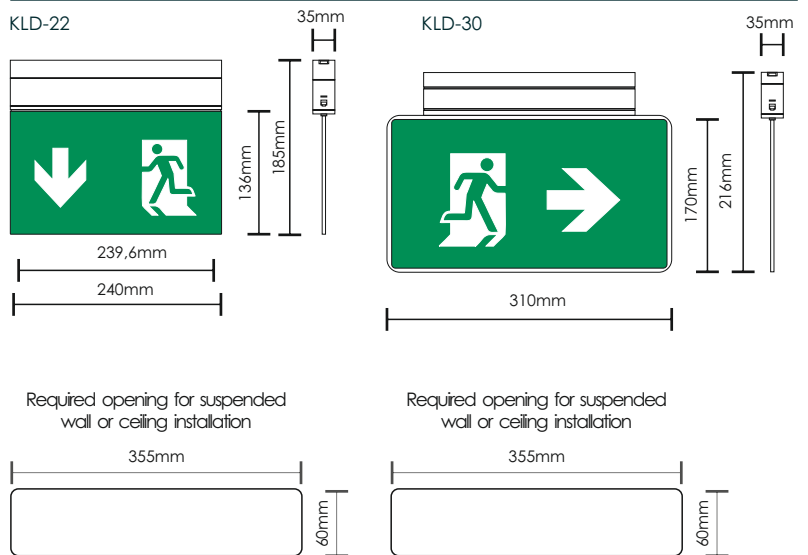



1  
KLD-22

1  
KLD-30

# ECO LIGHT



KM640081  
BS EN 60598-2-22

\*They have BSI certification

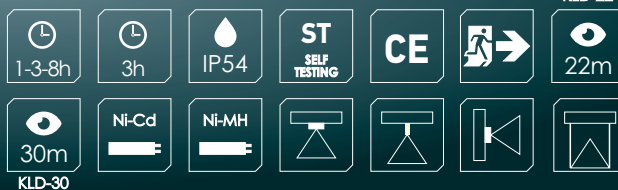

CODE	TYPE	ST	M	NM	IP	Battery	Runtime	Power	Dimensions	Weight
922502201	KLD-22/ST*	✓	✓	✓	IP54	3,6V/1,5Ah Ni-Mh	1-3-8 h	3,9W/4,4VA	80/250 80/110 80/15m	1104 gr.
922503051	KLD-30/ST*	✓	✓	✓	IP54	3,6V/1,5Ah Ni-Mh	1-3-8 h	3,9W/4,4VA	80/250 80/110 80/15m	1347 gr.
922502200	KLD-22	—	✓	✓	IP54	3,6V/1Ah Ni-Cd	3 h	3,2W/3,4VA	75/75m	1060 gr.
922503050	KLD-30	—	✓	✓	IP54	3,6V/1Ah Ni-Cd	3 h	3,2W/3,4VA	75/75m	1311 gr.

SINGLE-SIDE PICTOGRAMS		DESCRIPTION	INCLUDED	ON DEMAND	
CODE	TYPE				
804022001	SW-22/L	Marking overlay with left indication for 22m	✓		
804022000	SW-22/R	Marking overlay with right indication for 22m	✓		
804022003	SW-22/DL	Marking overlay with down left indication 22m	✓		
804022002	SW-22/DR	Marking overlay with down right indication 22m	✓		
804022004	SW-22/UR	Marking overlay with up right indication 22m		✓	
804022005	SW-22/UL	Marking overlay with up left indication 22m		✓	
804030001	SW-31/L	Marking overlay with left indication 30m	✓		
804030000	SW-31/R	Marking overlay with right indication 30m	✓		
804030003	SW-31/DL	Marking overlay with down left indication 30m	✓		
804030002	SW-31/DR	Marking overlay with down right indication 30m	✓		
804030004	SW-31/UR	Marking overlay with up right indication 30m		✓	
804030005	SW-31/UL	Marking overlay with up left indication 30m		✓	

ACCESSORIES ON DEMAND		DESCRIPTION	Weight
CODE	TYPE		kg
927321300	A-2130	Set of accessories (1m) for ceiling mounting (white)	375 gr.
927321310	A-2131	Set of accessories (0,5m) for ceiling mounting (white)	280 gr.
927321320	A-2132	Set of accessories (0,25m) for ceiling mounting (white)	139 gr.
927321330	A-2133	Accessory for vertical wall mounting (white)	108 gr.
927321360	A-2136	Accessory set for ceiling mounted hanging installations with 2,5m cable	164 gr.
927252000	A-2520/PL/ST	Suspended ceiling base for self-testing luminary KLD-xx	195 gr.
927252001	A-2520/PL	Suspended ceiling base	202 gr.



A-2130, A-2131,  
A-2132



A-2133

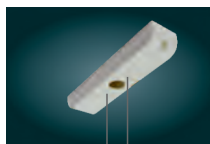

A-2136



A-2520/PL/ST



A-2520/PL

BATTERIES		
CODE	TYPE	DESCRIPTION
601103612	A-965/HT	Battery 3,6V/1,2Ah Ni-Mh
601223610	A-938/HT	Battery 3,6V/1Ah Ni-Cd



# ECO LIGHT



\*They have BSI certification

1-3-8h	IP54	ST SELF TESTING	CE		20m
Ni-Cd	Ni-MH				

## Mounting method

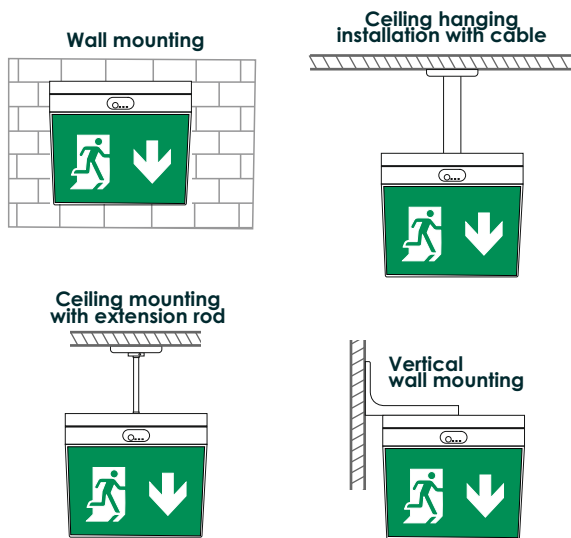

## Dimensions

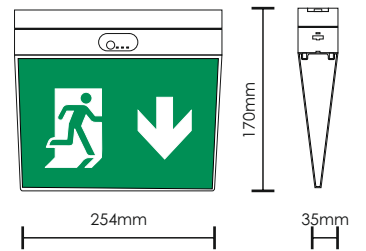

CODE	TYPE	ST	M	NM						
922502051	KLR-20/ST*	✓	✓	✓	IP54	3,6V/1,5Ah Ni-Mh	1-3 h	3,5W/4VA	80/250 80/110 80/15m	816 gr.
922502050	KLR-20	—	✓	✓	IP54	3,6V/1Ah Ni-Cd	3 h	3,2W/3,4VA	75/75m	816 gr.

SINGLE-SIDE PICTOGRAMS				
CODE	TYPE	DESCRIPTION	INCLUDED	ON DEMAND
804020001	SW-20/L	Marking overlay with left indication 20m	✓	
804020000	SW-20/R	Marking overlay with right indication 20m	✓	
804020003	SW-20/DL	Marking overlay with down left indication 20m	✓	
804020002	SW-20/DR	Marking overlay with down right indication for 20m	✓	
804020004	SW-20/UR	Marking overlay with up right indication 20m		✓
804020005	SW-20/UL	Marking overlay with up left indication 20m		✓

ACCESSORIES ON DEMAND			
CODE	TYPE	DESCRIPTION	kg
927321300	A-2130	Set of accessories (1m) for ceiling mounting (white)	375 gr.
927321310	A-2131	Set of accessories (0,5m) for ceiling mounting (white)	280 gr.
927321320	A-2132	Set of accessories (0,25m) for ceiling mounting (white)	139 gr.
927321330	A-2133	Accessory for vertical wall mounting (white)	108 gr.
927321360	A-2136	Accessory set for ceiling mounted hanging installations with 2,5m cable	164 gr.
927252000	A-2520/PL/ST	Suspended ceiling base for self-testing luminary KLD-xx	195 gr.
927252001	A-2520/PL	Suspended ceiling base	202 gr.



A-2130, A-2131,  
A-2132

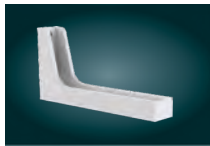

A-2133

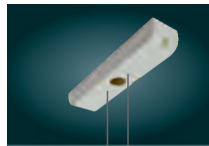

A-2136

BATTERIES		
CODE	TYPE	DESCRIPTION
601103612	A-965/HT	Battery 3,6V/1,2Ah Ni-Mh
601223610	A-938/HT	Battery 3,6V/1Ah Ni-Cd



## Mounting method

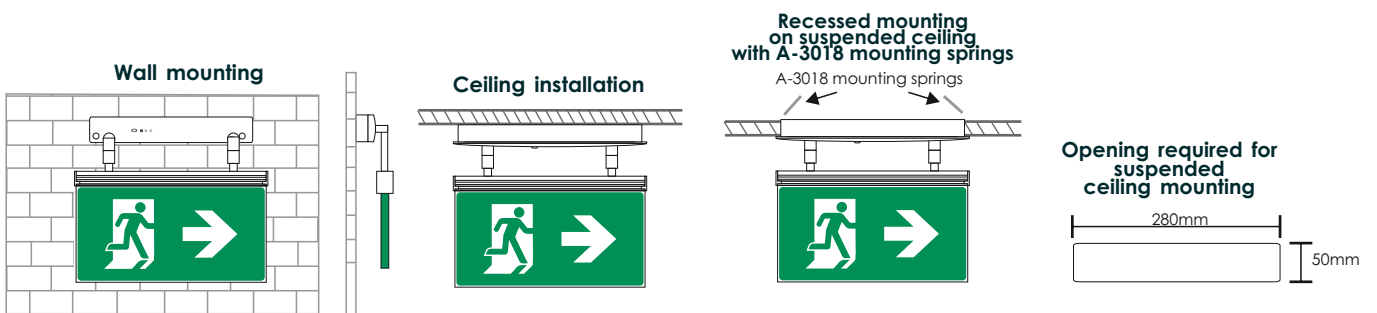

## Dimensions

### SLD/SP

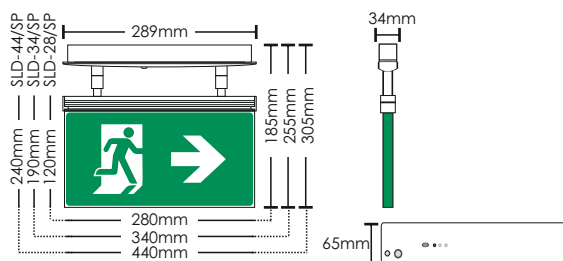

### SLD/DZ

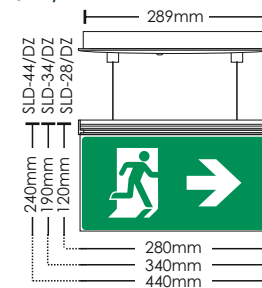



1  
SLD-xx/SP

2  
SLD-xx/DZ

# LOUNGE LIGHT



CODE	TYPE	IMAGE	ST	M	NM	IP	Battery	Runtime	Power	Mains/Emergency	Weight
922028008	SLD-28/SP	1	✓	✓	—	IP30	3,6V/1,5Ah Ni-Mh	3 h	9VA	100/100 lm	1010 gr.
922034009	SLD-34/SP	1	✓	✓	—	IP30	3,6V/1,5Ah Ni-Mh	3 h	9,5VA	125/125 lm	1448 gr.
922044006	SLD-44/SP	1	✓	✓	—	IP30	3,6V/1,5Ah Ni-Mh	3 h	9,5VA	125/125 lm	1900 gr.
922028000	SLD-28/DZ	2	✓	✓	—	IP30	3,6V/1,5Ah Ni-Mh	3 h	9VA	100/100 lm	1007 gr.
922034000	SLD-34/DZ	2	✓	✓	—	IP30	3,6V/1,5Ah Ni-Mh	3 h	9,5VA	125/125 lm	1358 gr.
922044000	SLD-44/DZ	2	✓	✓	—	IP30	3,6V/1,5Ah Ni-Mh	3 h	9,5VA	125/125 lm	1796 gr.

SINGLE-SIDE PICTOGRAMS		DESCRIPTION	INCLUDED	ON DEMAND	
CODE	TYPE				
804012228	SW-28/L	Pictogram Left ISO single side 16m	✓		
804012028	SW-28/R	Pictogram Right ISO single side 16m	✓		
804012328	SW-28/DL	Pictogram Down Left ISO single side 16m		✓	
804012128	SW-28/DR	Pictogram Down Right ISO single side 16m		✓	
804012428	SW-28/UR	Pictogram Up Right ISO single side 16m		✓	
804012429	SW-28/UL	Pictogram Up Left ISO single side 16m		✓	
804012534	SW-34/L	Pictogram Left ISO single side 30m	✓		
804012034	SW-34/R	Pictogram Right ISO single side 30m	✓		
804012634	SW-34/DL	Pictogram Down Left ISO single side 30m		✓	
804012134	SW-34/DR	Pictogram Down Right Right ISO single side 30m		✓	
804012234	SW-34/UR	Pictogram Up Right ISO single side 30m		✓	
804012235	SW-34/UL	Pictogram Up Left ISO single side 30m		✓	
804013544	SW-44/L	Pictogram Left ISO single side 38m	✓		
804013444	SW-44/R	Pictogram Right ISO single side 38m	✓		
804014544	SW-44/DL	Pictogram Down Left ISO single side 38m		✓	
804014444	SW-44/DR	Pictogram Down Right ISO single side 38m		✓	
804012444	SW-44/UR	Pictogram Up Right ISO single side 38m		✓	
804012445	SW-44/UL	Pictogram Up Left ISO single side 38m		✓	

ACCESSORIES		DESCRIPTION	INCLUDED	ON DEMAND	Weight
CODE	TYPE				
980330180	A-3018	Suspended ceiling mounting springs	✓		10,9 gr.

BATTERIES		DESCRIPTION
CODE	TYPE	
601103612	A-965/HT	Battery 3,6V/1,2Ah Ni-Mh



A-3018





# PROJECT LIGHT

1,5-3h	IP42	ST SELF TESTING	CE	<b>GRL-82x</b>	37m
49m <b>GRL-83x</b>	65m <b>GRL-84x</b>	Ni-Cd			

## Mounting method



**Ceiling mounting with extension rod 0,25-1m**

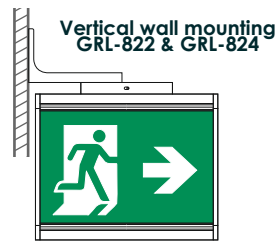
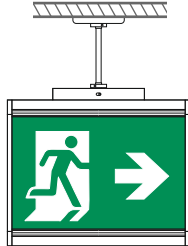

## Dimensions

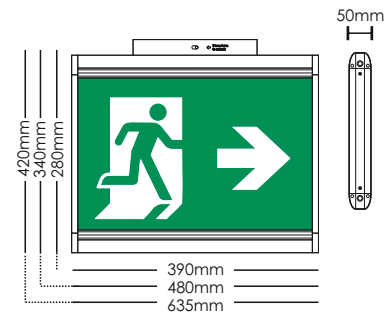

CODE	TYPE	ST	M	NM	IP	Battery	Time	Power	Mains/Emergency	kg
923822102	GRL-822/EM	✓	✓	✓	IP42	3,6V/1,5Ah Ni-Cd	1,5 h	7,5W/10,1VA	510/255 lm	1628 gr.
923824102	GRL-824/EM	✓	✓	✓	IP42	4,8V/1,5Ah Ni-Cd	3 h	7,5W/10,1VA	510/255 lm	1669 gr.
923832102	GRL-832/EM	✓	✓	✓	IP42	4,8V/1,5Ah Ni-Cd	1,5 h	9,8W/12,3VA	680/340 lm	2327 gr.
923834102	GRL-834/EM	✓	✓	✓	IP42	4,8V/3Ah Ni-Cd	3 h	10,1W/12,7VA	680/340 lm	2427 gr.
923842102	GRL-842/EM	✓	✓	✓	IP42	4,8V/1,5Ah Ni-Cd	1,5 h	11,7W/14,2VA	850/425 lm	2993 gr.
923844102	GRL-844/EM	✓	✓	✓	IP42	4,8V/3Ah Ni-Cd	3 h	12,1W/14,9VA	850/425 lm	3065 gr.

GRL-XXX/EM/○ All the above models can be manufactured as single sided luminaries with an aluminum backplate

SINGLE-SIDE PICTOGRAMS			INCLUDED	ON DEMAND	
CODE	TYPE	DESCRIPTION			
813860012	PL-86x/LO	Plexiglass 2mm with left indication for GRL-822/824/860 EM	✓		←
813860011	PL-86x/RO	Plexiglass 2mm with right indication for GRL-822/824/860 EM	✓		→
813860014	PL-86x/DLO	Plexiglass 2mm with down left indication for GRL-822/824/860 EM		—	↓
813860013	PL-86x/DRO	Plexiglass 2mm with down right indication for GRL-822/824/860 EM		—	↘
813860016	PL-86x/ULO	Plexiglass 2mm with up left indication for GRL-822/824/870 EM		—	↑
813860015	PL-86x/URO	Plexiglass 2mm with up right indication for GRL-822/824/860 EM		—	↗
813870010	PL-87x/LO	Plexiglass 2mm with left indication for GRL-832/834/860 EM	✓		←
813870009	PL-87x/RO	Plexiglass 2mm with right indication for GRL-832/834/860 EM	✓		→
813870012	PL-87x/DLO	Plexiglass 2mm with down left indication for GRL-832/834/860 EM		—	↓
813870011	PL-87x/DRO	Plexiglass 2mm with down right indication for GRL-832/834/860 EM		—	↘
813870014	PL-87x/ULO	Plexiglass 2mm with up left indication for GRL-832/834/860 EM		—	↑
813870013	PL-87x/URO	Plexiglass 2mm with up right indication for GRL-832/834/860 EM		—	↗
813880010	PL-88x/LO	Plexiglass 2mm with left indication for GRL-842/844/880 EM	✓		←
813880009	PL-88x/RO	Plexiglass 2mm with right indication for GRL-842/844/880 EM	✓		→
813880012	PL-88x/DLO	Plexiglass 2mm with down left indication for GRL-842/844/880 EM		—	↓
813880011	PL-88x/DRO	Plexiglass 2mm with down right indication for GRL-842/844/880 EM		—	↘
813880014	PL-88x/ULO	Plexiglass 2mm with up left indication for GRL-GRL-842/844/880 EM		—	↑
813880013	PL-88x/URO	Plexiglass 2mm with up right indication for GRL-GRL-842/844/880 EM		—	↗

ACCESSORIES ON DEMAND			kg
CODE	TYPE	DESCRIPTION	
927311300	A-1130	Set of accessories (1m) for ceiling mounting (silver)	375 gr.
927311310	A-1131	Set of accessories (0,5m) for ceiling mounting (silver)	280 gr.
927311320	A-1132	Set of accessories (0,25m) for ceiling mounting (silver)	139 gr.
927311330	A-1133	Accessory for vertical wall mounting (silver)	106,5 gr
927311340	A-1134	Accessory for wall mounting (silver)	111 gr.



A-1130, A-1131, A-1132

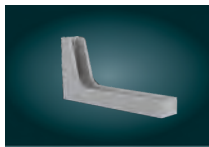

A-1133



A-1134

BATTERIES		
CODE	TYPE	DESCRIPTION
601213615	B-972/HT	Battery 3,6V/1,5Ah NiCd
601214815	B-973/HT	Battery 4,8V/1,5Ah Ni-Cd
601214830	B-941/HT	Battery 4,8V/3Ah Ni-Cd



# LED LIGHT BOX

1,5-3h	IP44	ST SELF TESTING	CE	→	LLB-26 26m
40m LLB-40	64m LLB-64	Ni-Mh	←	↖	

## Mounting method

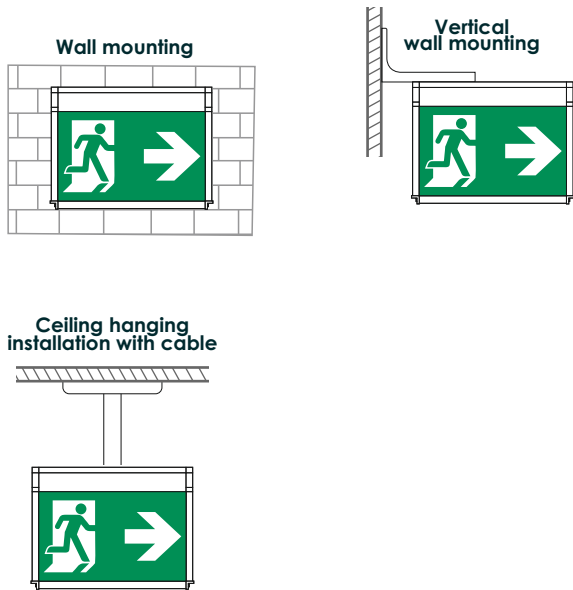

## Dimensions

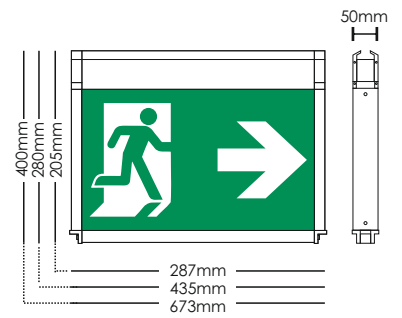

CODE	TYPE	ST	M	NM						kg
923026001	LLB-26/90	✓	✓	✓	IP44	4,8V/1,2Ah Ni-Mh	1,5 h	6W/6,4VA	230/300 lm	1072 gr.
923026003	LLB-26/180	✓	✓	✓	IP44	4,8V/1,2Ah Ni-Mh	3 h	6W/6,4VA	230/123 lm	1072 gr.
923040001	LLB-40/90	✓	✓	✓	IP44	4,8V/1,2Ah Ni-Mh	1,5 h	7W/7,4VA	370/300 lm	1774 gr.
923040003	LLB-40/180	✓	✓	✓	IP44	4,8V/2,4Ah Ni-Mh	3 h	7W/7,4VA	370/300 lm	1881 gr.
923064001	LLB-64/90	✓	✓	✓	IP44	4,8V/2Ah Ni-Mh	1,5 h	9,3W/9,8VA	600/500 lm	2445 gr.
923064003	LLB-64/180	✓	✓	✓	IP44	4,8V/4Ah Ni-Mh	3 h	9,3W/9,8VA	600/500 lm	3372 gr.

SINGLE-SIDE PICTOGRAMS			INCLUDED	ON DEMAND	
CODE	TYPE	DESCRIPTION			
804502612	PL-26/L	Plexiglass 2mm with left indication for LLB-26 26m	✓		
804502611	PL-26/R	Plexiglass 2mm with right indication for LLB-26 26m	✓		
804502610	PL-26/DL	Plexiglass 2mm with down left indication for LLB-26 26m		—	
804502609	PL-26/DR	Plexiglass 2mm with down right indication for LLB-26 26m		—	
804502614	PL-26/UL	Plexiglass 2mm with up left indication for LLB-26 26m		—	
804502613	PL-26/UR	Plexiglass 2mm with up right indication for LLB-26 26m		—	
804502615	PL-26/B	Plexiglass 2mm for LLB-26 26m		—	
804504011	PL-40/L	Plexiglass 2mm with left indication for LLB-40 40m	✓		
804504010	PL-40/R	Plexiglass 2mm with right indication for LLB-40 40m	✓		
804504013	PL-40/DL	Plexiglass 2mm with down left indication for LLB-40 40m		—	
804504012	PL-40/DR	Plexiglass 2mm with down right indication for LLB-40 40m		—	
804504015	PL-40/UL	Plexiglass 2mm with up left indication for LLB-40 40m		—	
804504014	PL-40/UR	Plexiglass 2mm with up right indication for LLB-40 40m		—	
804504016	PL-40/B	Plexiglass 2mm for LLB-40 40m		—	
804506411	PL-64/L	Plexiglass 2mm with left indication for LLB-64 64m	✓		
804506410	PL-64/R	Plexiglass 2mm with right indication for LLB-64 64m	✓		
804506413	PL-64/DL	Plexiglass 2mm with down left indication for LLB-64 64m		—	
804506412	PL-64/DR	Plexiglass 2mm with down right indication for LLB-64 64m		—	
804506415	PL-64/UL	Plexiglass 2mm with up left indication for LLB-64 64m		—	
804506414	PL-64/UR	Plexiglass 2mm with up right indication for LLB-64 64m		—	
804506416	PL-64/B	Plexiglass 2mm for LLB-64 64m		—	

BATTERIES		
CODE	TYPE	DESCRIPTION
601104812	C-930/HT	Battery 4,8V/1,2Ah Ni-Mh
601134820	B-954/HT	Battery 4,8V/2Ah Ni-Mh
601134840	B-936/HT60SC	Battery 4,8V/4Ah Ni-Mh

ACCESSORIES ON DEMAND			kg
CODE	TYPE	DESCRIPTION	
927311350	A-1135	Accessory for vertical wall mounting (For LLB-26/90/180)	204 gr.
927311360	A-1136	Accessory set for ceiling mounted hanging installations with 0,25m cable (For LLB-26 & LLB-40)	164 gr.
927311340	A-1134	Accessory for wall mounting	111 gr.



A-1135

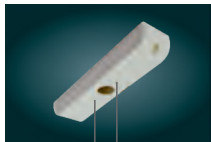

A-1136



A-1134





# 3D LIGHT



CODE	TYPE	ST	M	NM	IP	Battery	Runtime	Power	Beam Distance	Mains/Emergency	Weight	
923415003	GR-415/1PL	✓	✓	✓	IP40	4.8V/2Ah Ni-Mh	1-3.8 h	6.4W/6.4VA	370/370	370/270	370/100m	3370 gr.

SINGLE-SIDE PICTOGRAMS		DESCRIPTION	INCLUDED	ON DEMAND	
CODE	TYPE				
804000062	PL-4xx/L	Marking overlay with left indication	—	✓	
804000061	PL-4xx/R	Marking overlay with right indication	—	✓	
804000063	PL-4xx/DR	Marking overlay with down right indication	—	✓	
804000064	PL-4xx/UR	Marking overlay with up right indication	—	✓	
804000036	PL-4xx	Marking overlay without print			

BATTERIES		
CODE	TYPE	DESCRIPTION
601134820	B-954/HT	Battery 4.8V/2Ah Ni-Mh

## Mounting method



## Dimensions

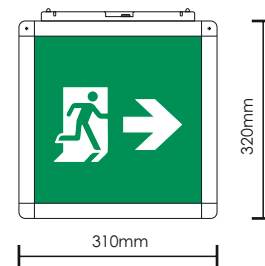



# TUNNEL LIGHT

Car passenger and freight transport are the dominant transport modes in EU and as modern road networks become more crowded, the use of tunnels and underpasses is expanding. Tunnel installations are demanding, due to limited maintenance access and corrosive atmospheric conditions and emergency luminaires have to satisfy the requirement for both reliable performance and absolute minimum of operation requirements.

The aim of evacuation lighting is to guide tunnel users during evacuation of the tunnel on foot in emergency circumstances. This aim is fulfilled with the use of emergency signs that unambiguously indicate the route of escape to a place of safety

Emergency exit signs in tunnel installations are manufactured in accordance to the following specifications

EN 16276:2013 Evacuation lighting in Road Tunnels: the standard specifies evacuation lighting in road tunnels longer than 500m and with an AADT (Annual Average Daily Traffic) higher than 500 vehicles.

EN 1838 Lighting applications: Emergency lighting: the standard specifies the luminous requirements for emergency escape lighting and standby lighting systems and is referenced in EN 16276:2013.

Directive 2004/54/EC: This Directive of the European Parliament specifies the minimum safety requirements for tunnels in the Trans-European Road Network.

CIE 88-2004: This technical report provides guidance for design of lighting systems of road tunnels and underpasses.

EN ISO 7010: the standard specifies the safety colors and safety signs in registered safety signs.

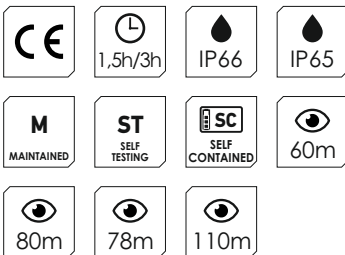





# TUNNEL LIGHT



CODE	TYPE	ST	M	NM				Mains/ Emergency
923573005	GR-573/L/316Ti/CBS/R	—	—	—	IP66	9,6W / 9,9VA		230cd/m2 (sign) - 120cd/m2 (indication)

SINGLE-SIDE PICTOGRAMS			
CODE	TYPE	DESCRIPTION	
804573001	PL-57x	Marking overlay indication	INCLUDED ON DEMAND ✓

## Mounting method

### Wall mounting

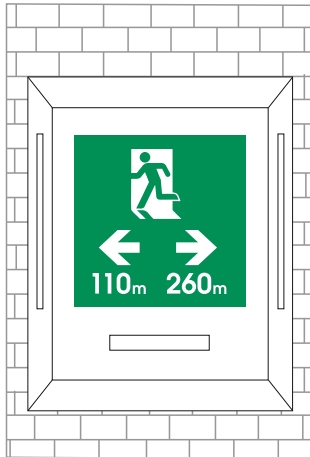

## Dimensions

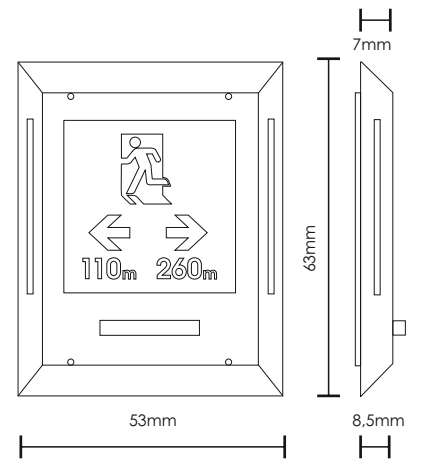



1

GR-579/L/90/WP  
GR-579/L/180/WP



# TUNEL LIGHT



CODE	TYPE	IMAGE	ST	M	NM	IP	Battery	Time	Power	Mains/Emergency
923579000	GR-579/L/90/WP	1	✓	✓	—	IP66	2x4.8V/1.5Ah Ni-Cd	1.5 h	2x9W/2x9.5VA	2 x 680m / 2 x 340m
923579001	GR-579/L/180/WP	1	✓	✓	—	IP66	2x4.8V/3Ah Ni-Cd	3 h	2x9W/2x9.5VA	2 x 680m / 2 x 340m
923577005	GR-577/L/15/ST/WP	2	✓	✓	—	IP65	4.8V/1.5Ah	1.5 h	9W/9.5VA	680/340m
923577006	GR-577/L/18/ST/WP	2	✓	✓	—	IP65	4.8V/1.5Ah	1.5 h	11.2W/11.7VA	850/425m
923578006	GR-578/L/15/ST/WP	2	✓	✓	—	IP65	4.8V/3Ah	3 h	9.5W/10VA	680/390m
923578007	GR-578/L/18/ST/WP	2	✓	✓	—	IP65	4.8V/3Ah	3 h	12W/12.5VA	850/425m

GR-XXX/L/XX/ST/WP/O All the above models can be manufactured as single sided with aluminum backplate.  
GR-XXX/L/XX/ST/WP/B All the above models can be manufactured with xenon red beacon on top.

BATTERIES		
CODE	TYPE	DESCRIPTION
601214815	B-973/HT	Battery 2x4.8V/1.5Ah Ni-Cd
601214815	B-973/HT	Battery 4.8V/1.5Ah Ni-Cd
601133640	B-975/HT	Battery 4.8V/3Ah Ni-Cd

Mounting method for GR-579/L/90/WP, GR-579/L/180/WP

### Wall mounting

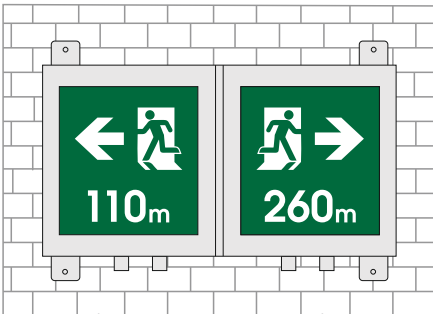

Dimensions

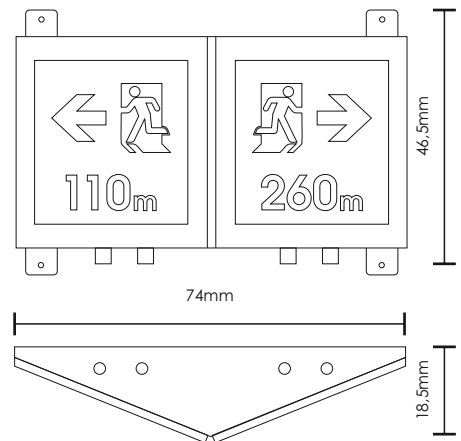

Mounting method for GR-577/L/15/ST/WP, GR-577/L/18/ST/WP,  
GR-578/L/15/ST/WP, GR-578/L/18/ST/WP

Double sided luminaire with exit marking sign mounted vertically to the wall with a base adapted to the geometry of the tunnel.

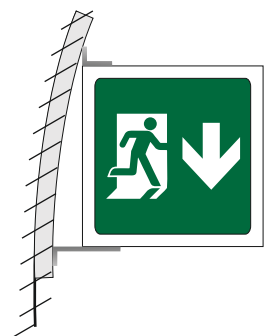

Double sided luminaire mounted vertically to the wall with emergency telephone marking sign.



Single sided luminaire mounted parallel to the wall with marking distances from the escape routes.

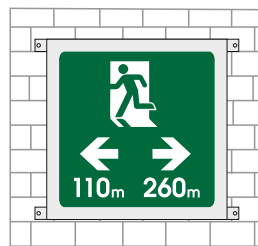

Dimensions

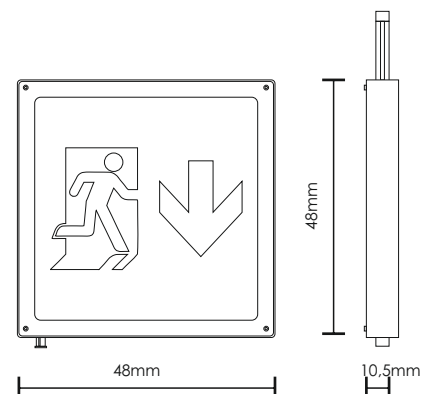



# POWER LED LIGHT

The emergency luminaires of the Power Light series are designed with large, industrial areas in mind. Two independently adjustable lenses and high power led light sources enable the luminaires of the series to better illuminate each installation space, satisfying the most demanding specifications. They are characterized by a robust construction with an impact rating of IK10 while the available versions with an

increased IP 65 rating are suitable for environmentally burdened spaces. The luminaires also come in versions with 1,5 and 3 hours of autonomy.

The Power Light series is suitable for large open areas with high ceilings such as warehouses and logistic centers, car parking, and large industrial installations.

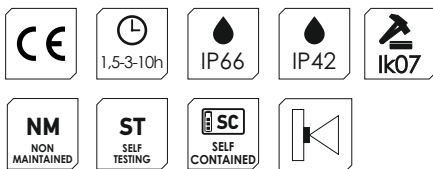

SWAROVSKI

SWAROVSKI  
PRESENTS  
KINGDOM

SWAROVSKI  
PRESENTS

SWAROVSKI  
PRESENTS  
KINGDOM  
OF JEWELS





# POWER LED LIGHT



CODE	TYPE	IMAGE	ST	M	NM	IP	Battery	Time	Power	Light Source	Mains/Emergency	kg
923021031	GRL-21	1	—	—	✓	IP42	6V/4Ah Pb	1,5 h	5,6W/7,5VA	2x42 Leds	790 lm	2210 gr.
923021040	GRL-21/H/90	1	—	—	✓	IP42	12V/7Ah Pb	1,5 h	13,3W/14VA	2x6P Leds	3200 lm	4303 gr.
923021042	GRL-21/H/180	1	—	—	✓	IP42	2x12V/7Ah Pb	3 h	13,3W/14VA	2x6P Leds	3200 lm	6781 gr.
923022100	GRL-22	3	—	—	✓	IP42	12V/7Ah Pb	10 h	16VA	84 Leds	710 lm	3270 gr.
923021041	GRL-21/H/90/WP	2	—	—	✓	IP65	12V/7Ah Pb	1,5 h	13,3W/14VA	2x6P Leds	3200 lm	3587 gr.
923021043	GRL-21/H/180/WP	2	—	—	✓	IP65	2x12V/7Ah Pb	3 h	13,3W/14VA	2x6P Leds	3200 lm	6065 gr.
923037002	GRL-37/90*	1	✓	—	✓	IP42	12V/7Ah Pb	1,5 h	13,3W/14VA	2x6P Leds	3200 lm	4383 gr.
923037005	GRL-37/180*	1	✓	—	✓	IP42	2x12V/7Ah Pb	3 h	13,3W/14VA	2x6P Leds	3200 lm	6544 gr.
923029009	GRL-29	1	✓	—	✓	IP42	12V/7Ah Pb	3 h	12,6W / 13,1VA	2x84 Leds	1760 lm	3658 gr.
923038000	GRL-38/90/M	1	✓	—	✓	IP42	12V/7Ah Pb	1,5 h	13,3W/14VA	2x1COB Leds	3000 lm	4407 gr.
923037004	GRL-37/90/WP*	2	✓	—	✓	IP65	12V/7Ah Pb	1,5 h	13,3W/14VA	2x6P Leds	3200 lm	4602 gr.
923037006	GRL-37/180/WP*	2	✓	—	✓	IP65	2x12V/7Ah Pb	3 h	13,3W/14VA	2x6P Leds	3200 lm	6763 gr.
923029010	GRL-29/WP	2	✓	—	✓	IP65	12V/7Ah Pb	3 h	12,6W/13,1VA	2x84 Leds	1760 lm	3888 gr.

## SINGLE-SIDE PICTOGRAMS FOR GRL-22

CODE	TYPE	DESCRIPTION	INCLUDED	ON DEMAND
807008019	S-00800/LO	Marking overlay with left indication	✓	
807008017	S-00800/RO	Marking overlay with right indication	✓	
807008021	S-00800/DO	Marking overlay with down indication	✓	
807008023	S-00800/UO	Marking overlay with up indication	—	

## BATTERIES

CODE	TYPE	DESCRIPTION
603000645	A-988	Battery 6V/4,5Ah
603001270	A-986	Battery 12V/7Ah

## Mounting method

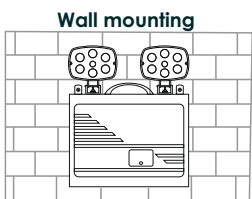

## Dimensions Image 1 & 2

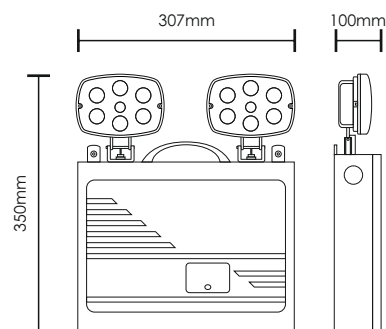

## Photometric

GRL-21/H, GRL-37, GRL-38

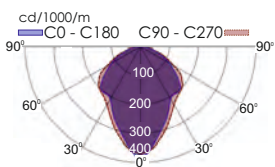

GRL-21, GRL-22, GRL-29

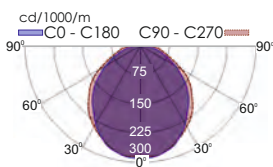

## Dimensions Image 3

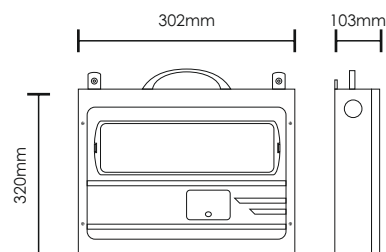



- Designed for installation in explosive atmospheres
- The main body is constructed of aluminum (painted yellow, RAL-1003) and the diffuser from polycarbonate with UV-protection or with special durable glass.
- The luminaires that contain batteries have a charge indicator and connector for installing a remote test button.

#### General characteristics

- Ni-Cd batteries
- High power illumination
- Suitable for explosive gas atmospheres and explosive dust atmospheres
- IP66, IK05 & IK07 degrees of cover protection
- Charge indication LED
- Construction material: Aluminum and Polycarbonate or Aluminum and glass
- Operation temperature range: 0 C up to 40 C the emergency luminaires, -20 C up to 40 C for the CBS luminaires
- Complying with the ATEX 94/9/EC
- Humidity: up-to 95% relative humidity

#### Dimensions

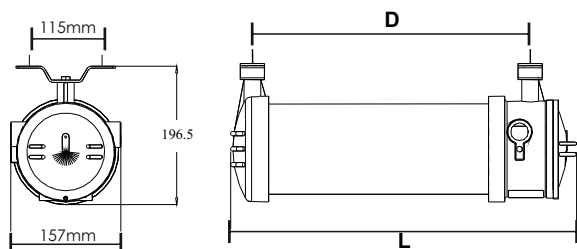

CATEGORY	Dimensions DxL
E1	375mmx485mm
E2	640mmx750mm

# ANTIEXPLOSIVE LED LIGHT



Polycarbonate Glass

1-3h IP66 CE Ik07 Ik05

Ex db IIC T6 Gb  
Ex tb IIIC T85 Db

Ex

CODE	TYPE	ST	M	NM	IP66	6V/1,6Ah	1 h	< 130mA	DIFFUSER	Mains/ Emergency	DIMENSIONS	kg
923411701	PTD1700XP	✓	✓	✓	IP66	6V/1,6Ah	1 h	< 130mA	Polycarbonate	2100/750lm	E1	4.600 gr.
923412703	PTD2700XP	—	✓	✓	IP66	6V/1,6Ah	1 h	< 190mA	Polycarbonate	4600/750lm	E2	5.900 gr.
923412707	PTD2700XP3	—	✓	✓	IP66	6V/4Ah	3 h	< 200mA	Polycarbonate	4600/750lm	E2	6.300 gr.
923411703	GTD1700XP	—	✓	✓	IP66	6V/1,6Ah	1 h	< 130mA	Glass 5mm	2400/800lm	E1	5.400 gr.
923412711	GTD2700XP	—	✓	✓	IP66	6V/1,6Ah	1 h	< 190mA	Glass 5mm	4800/800lm	E2	6.600 gr.
923412715	GTD2700XP3	—	✓	✓	IP66	6V/4Ah	3 h	< 200mA	Glass 5mm	4800/800lm	E2	7.000 gr.
923411401	PTD1400X	—	—	✓	IP66	3,6V/1,6Ah	1 h	< 25mA	Polycarbonate	350lm	E1	4.745 gr.
923412701	PTD2700X	—	—	✓	IP66	6V/1,6Ah	1 h	< 25mA	Polycarbonate	750lm	E2	5.800 gr.
923411403	PTD1400X3	—	—	✓	IP66	3,6V/4Ah	3 h	< 30mA	Polycarbonate	350lm	E1	4.700 gr.
923412705	PTD2700X3	—	—	✓	IP66	6V/4Ah	3 h	< 35mA	Polycarbonate	750lm	E2	6.200 gr.
923411405	GTD1400X	—	—	✓	P66	3,6V/1,6Ah	1 h	< 25mA	Glass 5mm	400lm	E1	5.300 gr.
923412709	GTD2700X	—	—	✓	IP66	6V/1,6Ah	1 h	< 25mA	Glass 5mm	800lm	E2	6.500 gr.
923411407	GTD1400X3	—	—	✓	IP66	3,6V/4Ah	3 h	< 30mA	Glass 5mm	400lm	E1	5.500 gr.
923412713	GTD2700X3	—	—	✓	IP66	6V/4Ah	3 h	< 35mA	Glass 5mm	800lm	E2	6.900 gr.

## SINGLE-SIDE PICTOGRAMS

CODE	TYPE	DESCRIPTION	INCLUDED	ON DEMAND
705690016	S65/L	Marking overlay with left indication	✓	
705690017	S65/R	Marking overlay with right indication	✓	
705690018	S65/D	Marking overlay with down indication	✓	
705690019	S65/U	Marking overlay with up indication		✓

## INCLUDED IN THE PACKAGE

CODE	TYPE	DESCRIPTION	kg
751500102	NPT34	Sealing grommet	105,5 gr.
808700069	A-FSA	Mounting base	156,5 gr.



NPT34

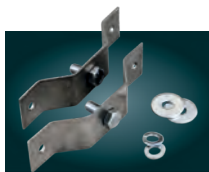

A-FSA

## Mounting methods

### Wall mounting

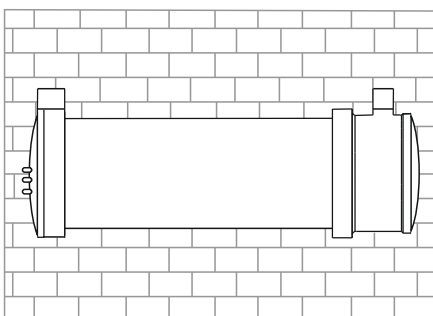

### Ceiling installation with A-FSA mounting base

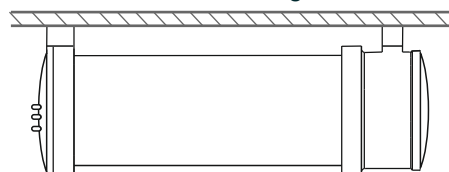





# SPOT LIGHT

Olympia Electronics's SpotLight luminaires are designed to provide safety illumination with lenses appropriately designed for use in either open areas or escape routes.

The GRL-2XX series of the SpotLight family of luminaires finds application in installations that require the discreet presence of safety luminaires such as hotels and high-rise apartment buildings, while the GR-4XX range can be used to meet safety lighting requirements in sports or industrial installations, providing easy cabling to the electrician installer. SpotLight family lamps are divided into two basic versions:

- GR-2XX: suitable for recessed installation in suspended ceilings and use in large spaces with high ceilings, where the discreet presence of luminaires is required

- GR-4XX: designed for installation under cable trays and for use in industrial or parking spaces.

The SpotLight family of luminaires is available in versions with IP40 and IP42 or IP65 degree of waterproof for use in harsh environmental conditions, while there are versions with a range of 1.5 or 3 hours. In addition, the GR-29X / M / HL luminaire series is suitably designed for recessed installation in areas with high ceilings where a range of 3 hours is required.

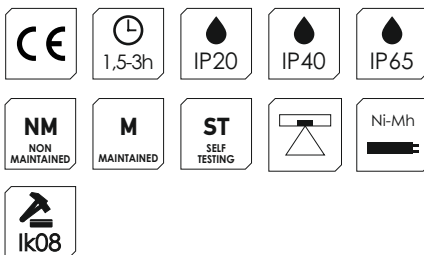



- 1  
Open areas
- 2  
Escape routes
- 3  
Open areas/  
Escape routes
- 4  
Points of interest



# SPOT LIGHT



CODE	TYPE	IMAGE	ST	M	NM	Water	Battery	Time	Power	Mains/Emergency	INSTALLATION	kg
923291007	GR-291/M	1	✓	—	✓	IP40	4,8V/1,2Ah Ni-Mh	1,5 h	4,3W/4,7VA	300 lm	Open areas	543 gr.
923293003	GR-293/M	1	✓	—	✓	IP40	4,8V/1,2Ah Ni-Mh	3 h	4,3W/4,7VA	150 lm	Open areas	543 gr.
923290006	GR-290/M	2	✓	—	✓	IP40	4,8V/1,2Ah Ni-Mh	1,5 h	4,3W/4,7VA	300 lm	Escape routes	543 gr.
923292003	GR-292/M	2	✓	—	✓	IP40	4,8V/1,2Ah Ni-Mh	3 h	4,3W/4,7VA	150 lm	Escape routes	543 gr.
923291008	GR-291/WP/M	1	✓	—	✓	IP65	4,8V/1,2Ah Ni-Mh	1,5 h	4,3W/4,7VA	300 lm	Open areas	543 gr.
923293004	GR-293/WP/M	1	✓	—	✓	IP65	4,8V/1,2Ah Ni-Mh	3 h	4,3W/4,7VA	150 lm	Open areas	543 gr.
923290007	GR-290/WP/M	2	✓	—	✓	IP65	4,8V/1,2Ah Ni-Mh	1,5 h	4,3W/4,7VA	300 lm	Escape routes	543 gr.
923292004	GR-292/WP/M	2	✓	—	✓	IP65	4,8V/1,2Ah Ni-Mh	3 h	4,3W/4,7VA	150 lm	Escape routes	543 gr.
923292007	GR-292/M/HL	2	✓	—	✓	IP20	4,8V/4Ah Ni-Mh	3 h	4,9W/5,2VA	330 lm	Escape routes	818 gr.
923293007	GR-293/M/HL	1	✓	—	✓	IP20	4,8V/4Ah Ni-Mh	3 h	4,9W/5,2VA	330 lm	Open areas	818 gr.
923271000	GR-271*	1	—	—	✓	IP40	3,6V/1,2Ah Ni-Mh	1,5 h	2,4W/2,7VA	160 lm	Open areas	450 gr.
923273000	GR-273*	1	—	—	✓	IP40	3,6V/1,2Ah Ni-Mh	3 h	2,4W/2,7VA	120 lm	Open areas	450 gr.
923270000	GR-270*	2	—	—	✓	IP40	3,6V/1,2Ah Ni-Mh	1,5 h	2,4W/2,7VA	160 lm	Escape routes	450 gr.
923272000	GR-272*	2	—	—	✓	IP40	3,6V/1,2Ah Ni-Mh	3 h	2,4W/2,7VA	120 lm	Escape routes	450 gr.
923290008	GR-290/WP	2	✓	—	✓	IP65	4,8V/1,2Ah Ni-Mh	1,5 h	3,7W/4,1VA	270 lm	Escape routes	456 gr.
923291009	GR-291/WP	1	✓	—	✓	IP65	4,8V/1,2Ah Ni-Mh	1,5 h	3,7W/4,1VA	270 lm	Open areas	456 gr.
923292005	GR-292/WP	2	✓	—	✓	IP65	4,8V/1,2Ah Ni-Mh	3 h	3,7W/4,1VA	160 lm	Escape routes	456 gr.
923293005	GR-293/WP	1	✓	—	✓	IP65	4,8V/1,2Ah Ni-Mh	3 h	3,7W/4,1VA	160 lm	Open areas	456 gr.
923290000	GR-290**	2	✓	—	✓	IP40	4,8V/1,2Ah Ni-Mh	1,5 h	3,7W/4,1VA	270 lm	Escape routes	456 gr.
923291000	GR-291**	1	✓	—	✓	IP40	4,8V/1,2Ah Ni-Mh	1,5 h	3,7W/4,1VA	270 lm	Open areas	456 gr.
923292000	GR-292**	2	✓	—	✓	IP40	4,8V/1,2Ah Ni-Mh	3 h	3,7W/4,1VA	160 lm	Escape routes	456 gr.
923293000	GR-293**	1	✓	—	✓	IP40	4,8V/1,2Ah Ni-Mh	3 h	3,7W/4,1VA	160 lm	Open areas	456 gr.
923298000	GR-298/30L/180	3	✓	—	✓	IP40	4,8V/1,2Ah Ni-Mh	3 h	3,3W/3,7VA	220 lm	Open areas/ Escape routes	535 gr.
923298001	GR-298/60L/90	3	✓	—	✓	IP40	4,8V/1,2Ah Ni-Mh	1,5 h	3,3W/3,7VA	450 lm	Open areas/ Escape routes	535 gr.
923298003	GR-298/60L/90/WP	3	✓	—	✓	IP65	4,8V/1,2Ah Ni-Mh	1,5 h	3,3W/3,7VA	450 lm	Open areas/ Escape routes	535 gr.
923297000	GR-297/60L/180	3	—	✓	—	IP40	4,8V/1,2Ah Ni-Mh	3 h	5,9W/7,3VA	350/110 lm	Open areas/ Escape routes	535 gr.
923266000	GR-266/M	4	✓	—	✓	IP40	4,8V/1,2Ah Ni-Mh	1,5 h	4,3W/4,7VA	300 lm	Points of interest	442 gr.
923267000	GR-267/M	4	✓	—	✓	IP40	4,8V/1,2Ah Ni-Mh	3 h	4,3W/4,7VA	150 lm	Points of interest	442 gr.

## BATTERIES

CODE	TYPE	DESCRIPTION
601134840	B-936/HT60SC	Battery 4,8V/4Ah Ni-Mh
601104812	C-930/HT	Battery 4,8V/1,2Ah Ni-Mh
601103612	A-965/HT	Battery 3,6V/1,2Ah Ni-Mh

## Mounting methods

### Ceiling mounting

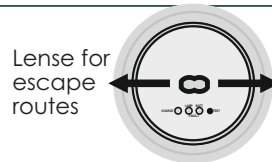
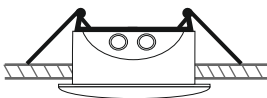

GR-290, GR-292,  
GR-270, GR-272



GR-291, GR-293,  
GR-271, GR-273

## Dimensions

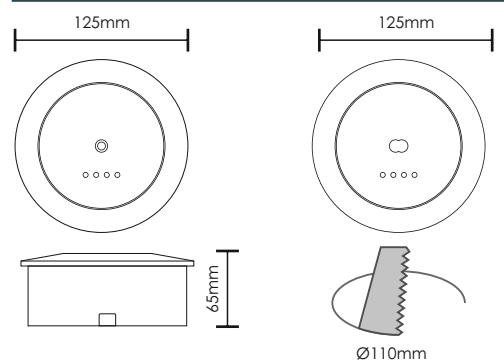

## Photometric

### GR-291 & GR-293

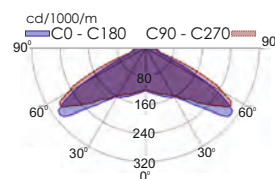

### GR-290 & GR-292

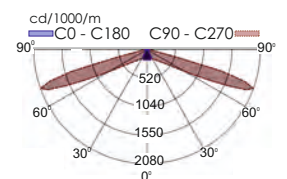



1 Open areas

2

With two interchangeable lenses.  
One for corridor and one for open areas



2

KIT-77/84

# SPOT LIGHT

ST  
SELF  
TESTING

1,5-3h

IP40

Ni-Mh



CODE	TYPE	IMAGE	ST	M	NM	IP	Battery	Time	Power	Mains/Emergency	Weight
923220000	GR-220/DUO/M	1	✓	—	—	IP40	4,8V/1,2Ah Ni-Mh	1,5 h	4,3W/4,7VA	300 lm	474 gr.
923221000	GR-221/DUO/M	1	✓	—	✓	IP40	4,8V/1,2Ah Ni-Mh	3 h	4,3W/4,7VA	150 lm	474 gr.
923084001	KIT-77/84*	2	—	—	—	IP20	4,8V/1,2Ah Ni-Mh	3 h	2,5W/6VA	140 lm	262 gr

\*The KIT contains GR-77 electronic ballast, GR-84 emergency luminaire & Ni-Mh battery

## BATTERIES

CODE	TYPE	DESCRIPTION
601104812	C-930/HT	Battery 4,8V/1,2Ah Ni-Mh

## Mounting methods

### Ceiling mounting

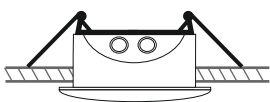

Lens for escape routes

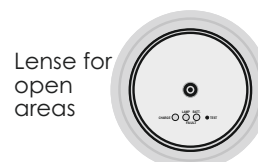

Lens for open areas

## Dimensions

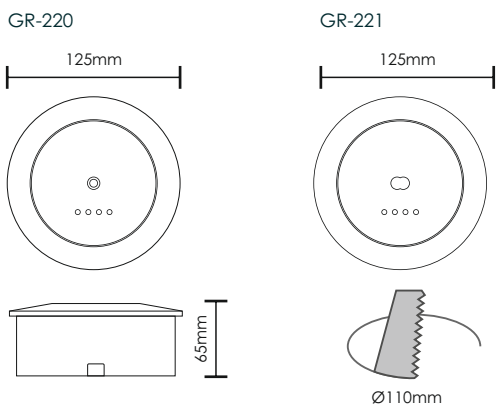

## Photometric

### Lens for open area

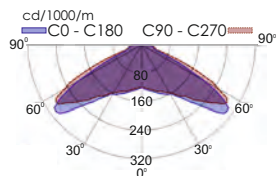

### Lens for escape routing

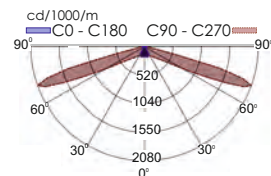

### KIT-77/84

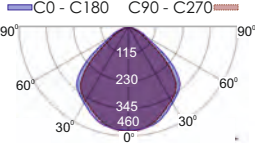

## KIT-77/84\*

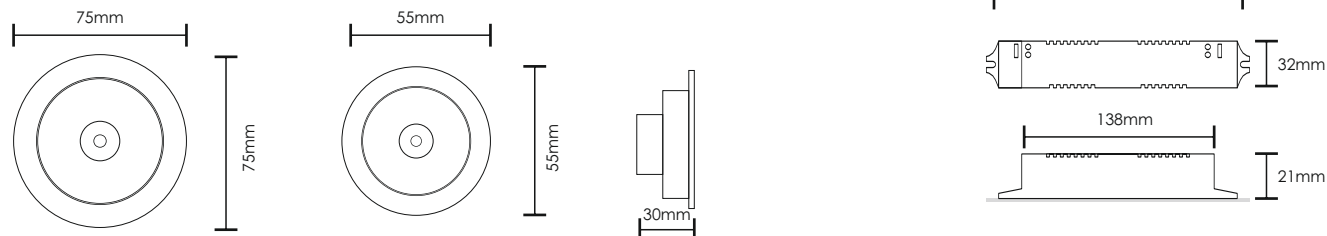

# TETRAGONO LIGHT



CODE	TYPE	ST	M	NM	IP	Battery	Time	Power	Mains/Emergency	INSTALLATION	kg
923491001	GR-491	✓	—	✓	IP40	4,8V/1,2Ah Ni-Mh	1,5 h	3,9W/4,4VA	280 lm	Open areas	843 gr.
923493001	GR-493	✓	—	✓	IP40	4,8V/1,2Ah Ni-Mh	3 h	3,9W/4,4VA	140 lm	Open areas	843 gr.
923490001	GR-490	✓	—	✓	IP40	4,8V/1,2Ah Ni-Mh	1,5 h	3,9W/4,4VA	280 lm	Escape routes	843 gr.
923492001	GR-492	✓	—	✓	IP40	4,8V/1,2Ah Ni-Mh	3 h	3,9W/4,4VA	140 lm	Escape routes	843 gr.
923491000	GR-491/WP	✓	—	✓	IP65	4,8V/1,2Ah Ni-Mh	1,5 h	3,9W/4,4VA	280 lm	Open areas	852 gr.
923493000	GR-493/WP	✓	—	✓	IP65	4,8V/1,2Ah Ni-Mh	3 h	3,9W/4,4VA	140 lm	Open areas	852 gr.
923490000	GR-490/WP	✓	—	✓	IP65	4,8V/1,2Ah Ni-Mh	1,5 h	3,9W/4,4VA	280 lm	Escape routes	852 gr.
923492000	GR-492/WP	✓	—	✓	IP65	4,8V/1,2Ah Ni-Mh	3 h	3,9W/4,4VA	140 lm	Escape routes	852 gr.
923471001	GR-471	—	—	✓	IP42	3,6V/1Ah Ni-Cd	1,5 h	2,6W/2,9VA	145 lm	Open areas	727 gr.
923473001	GR-473	—	—	✓	IP42	3,6V/1Ah Ni-Cd	3 h	2,6W/2,9VA	80 lm	Open areas	727 gr.
923470001	GR-470	—	—	✓	IP42	3,6V/1Ah Ni-Cd	1,5 h	2,6W/2,9VA	145 lm	Escape routes	727 gr.
923472001	GR-472	—	—	✓	IP42	3,6V/1Ah Ni-Cd	3 h	2,6W/2,9VA	80 lm	Escape routes	727 gr.
923471000	GR-471/WP	—	—	✓	IP65	3,6V/1Ah Ni-Cd	1,5 h	2,6W/2,9VA	145 lm	Open areas	745 gr.
923473000	GR-473/WP	—	—	✓	IP65	3,6V/1Ah Ni-Cd	3 h	2,6W/2,9VA	80 lm	Open areas	745 gr.
923470000	GR-470/WP	—	—	✓	IP65	3,6V/1Ah Ni-Cd	1,5 h	2,6W/2,9VA	145 lm	Escape routes	745 gr.
923472000	GR-472/WP	—	—	✓	IP65	3,6V/1Ah Ni-Cd	3 h	2,6W/2,9VA	80 lm	Escape routes	745 gr.

The packaging contains 12pcs.

## BATTERIES

CODE	TYPE	DESCRIPTION
601104812	C-930/HT	Battery 4,8V/1,2Ah Ni-Mh
601223610	A-938/HT	Battery Ni-Cd 3,6V/1Ah Ni-Cd

## Mounting methods

### Ceiling mounting

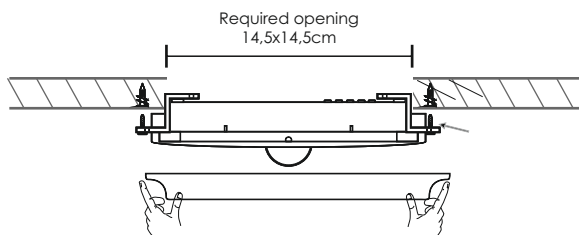

### Dimensions

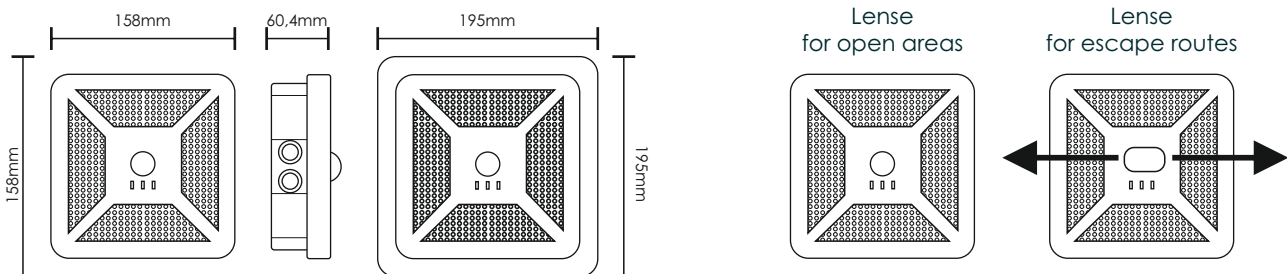

## Photometric

### GR-4x0, GR-4x2

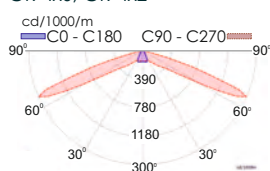

### GR-4x1, GR-4x3

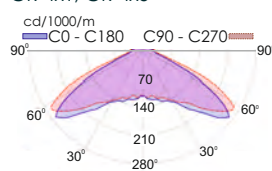

# WEATHER SPOTLIGHT



CODE	TYPE	IMAGE	RECHARGEABLE	M	NM	IP	Battery	Runtime	Power	Mains/Emergency	Weight
923083001	GR-83	1	✓	—	✓	IP40	3,6V/120mAh Ni-Mh	3 h	2VA	4 white LED	99 gr.
923080001	GR-80/W	1	—	—	—	IP65	—	—	6VA	9 LED	100,5 gr.
923080002	GR-80/W/SL*	1	—	—	—	IP65	—	—	6VA	9 LED	103,5 gr.
923080013	GR-80/WW**	1	—	—	—	IP65	—	—	6VA	9 LED	103,5 gr.
923082001	GR-82/230V	2	✓	✓	—	IP40	3,6V/120mAh Ni-Mh	3 h	4VA	1 lm / 22 lm	99,5 gr.
923082006	GR-82/230V/SQ**	2	✓	✓	—	IP40	3,6V/120mAh Ni-Mh	3 h	4VA	1 lm / 22 lm	115 gr.
923082002	GR-82/WP/230V	3	✓	✓	—	IP65	3,6V/120mAh Ni-Mh	3 h	4VA	1 lm / 22 lm	115 gr.
923082009	GR-82/WP/230V/SQ**	3	✓	✓	—	IP65	3,6V/120mAh Ni-Mh	3 h	4VA	1 lm / 22 lm	125 gr.

\* GR-80/W/SL - Silver case

\*\* Initials SQ stand for square case

The packaging contains 100pcs.

## BATTERIES

CODE	TYPE	DESCRIPTION
601103601	A-947	Battery 3,6V/120mAh Ni-Mh

## Mounting methods

### Ceiling mounting

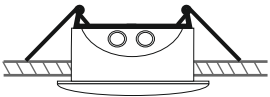

## Dimensions

### Image 1

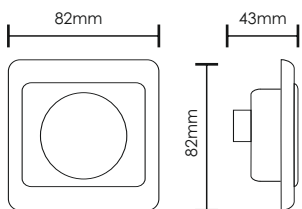

### Image 2

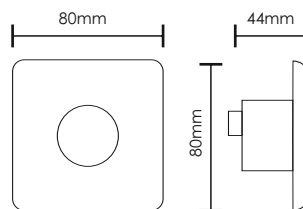

### Image 3

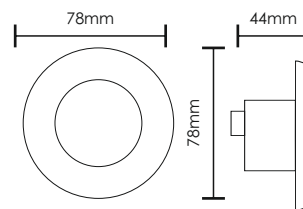



1  
GR-60



2  
GR-11

# HOME LIGHT



CODE	TYPE	IMAGE	RECHARGEABLE	M	NM	IP	Battery	Runtime	Power	Mains/Emergency	Weight
923060000	GR-60	1	✓	✓	—	IP20	3,6V/1Ah Ni-Cd	4 - 14 h	3VA	40m/23-95lm	539 gr.
923011000	GR-11	2	✓	✓	—	IP20	3,6V/120mAh Ni-MH	3 h	3VA	-	85 gr.

The GR-60 packaging contains 20pcs and the GR-11 10pcs.

## BATTERIES

CODE	TYPE	DESCRIPTION
601233610	A-931/HT	Battery 3,6V/1Ah Ni-Cd
*601103601	A-947	Battery 3,6V/120mAh Ni-Mh

## Dimensions

### GR-60

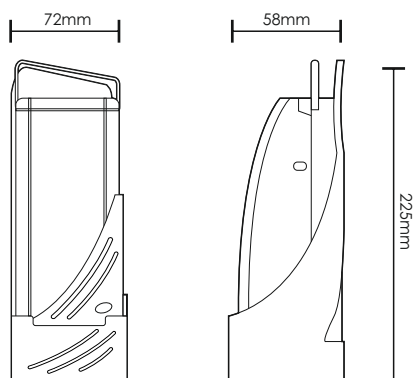

### GR-11

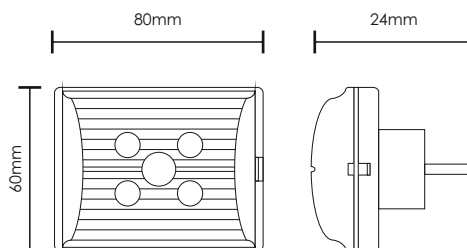

# CONVERTERS





# CONVERTERS FOR FLUORESCENT LUMINARIES

PROGRAMMABLE COMMON TO EMERGENCY LUMINARY CONVERTER FOR FLUORESCENT LAMPS T5/T8 6-80W 220-240V AC / 50-60Hz (without battery)

CODE	TYPE	DESCRIPTION					
960100400	GR-1004	Programmable converter for fluorescent tubes 90min lamps 80W T5	IP20	4,8 - 8,4 V/1,5 - 4Ah	1 - 3 h	13VA	129 gr.

NON PROGRAMMABLE CONVERTERS FOR FLUORESCENT LAMPS T5/T8 6-80W 220-240V AC / 50-60Hz

CODE	TYPE	DESCRIPTION					
960100461	GR-1004-A/61	Converter for fluorescent tubes with battery	IP20	4,8V/1,5Ah	1,5 h	13VA	418 gr.
960100462	GR-1004-B/62	Converter for fluorescent tubes with battery	IP20	4,8V/3Ah	3 h	13VA	510 gr.
960100471	GR-1004-C/71	Converter for fluorescent tubes with battery	IP20	8,4V/1,5Ah	1,5 h	13VA	520 gr.
960100472	GR-1004-D/72	Converter for fluorescent tubes with battery	IP20	8,4V/3Ah	3 h	13VA	695 gr.
960100481	GR-1004-E/81	Converter for fluorescent tubes with battery	IP20	6V/1,5Ah	1,5 h	13VA	235 gr.
960100482	GR-1004-F/82	Converter for fluorescent tubes with battery	IP20	6V/3Ah	3 h	13VA	360 gr.

TYPE	GR-4/UN/A-966	GR-4/UN/65	GR-4/UN/66	GR-4/UN/67	GR-6/UN/61	GR-6/UN/62	GR-6/UN/64
18W (T8)	-----	90 min.	180 min.	240 min.	80 min.	160 min.	220 min.
36W (T8)	-----	70 min.	140 min.	180 min.	60 min.	120 min.	160 min.
58W (T8)	-----	60 min.	120 min.	160 min.	50 min.	100 min.	140 min.
18W (COMPACT)	-----	90 min.	180 min.	240 min.	80 min.	160 min.	220 min.
38W (2D/4PIN)	-----	70 min.	140 min.	180 min.	60 min.	130 min.	170 min.
36W (COMPACT)	-----	70 min.	140 min.	180 min.	70 min.	130 min.	180 min.
7-9W CFL	60 min.	-----	-----	-----	-----	-----	-----

Type	Battery	6W (T5)	8W (T5)	11W (CFL)	13W (CFL)	14W (T5)	18W (CFL)	21W (T5)	24W (T5)	24W (CFL)	28W (T5)	32W(CIRC)	32W (CFL)	35W(T5)	36W(T8)	36W (CFL)	49W(T5)	54W(T5)	55W(CFL)	58W(T8)	80W(T5)	Duration
GR-1004-A/61	4,8V - 1,5Ah	●	●	●	●	●	●	●	●	●												90'
GR-1004-B/62	4,8V - 3Ah	●	●	●	●	●	●	●	●	●												3 h
GR-1004-C/71	8,4V - 1,5Ah	●	●	●	●	●	●	●	●	●	●	●	●	●	●	●	●	●	●	●	●	90'
GR-1004-D/72	8,4V - 3Ah	●	●	●	●	●	●	●	●	●	●	●	●	●	●	●	●	●	●	●	●	3 h
GR-1004-E/81	6V - 1,5Ah	●	●	●	●	●	●	●	●	●	●	●	●	●	●	●	●					90'
GR-1004-F/82	6V - 3Ah	●	●	●	●	●	●	●	●	●	●	●	●	●	●	●	●					3 h

## Dimensions

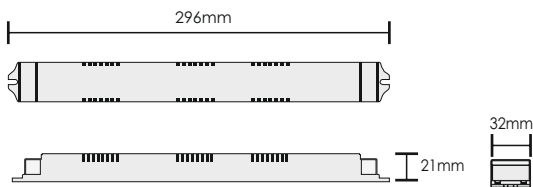

BATTERIES		
CODE	TYPE	DESCRIPTION
601214815	B-973/HT	Battery 4,8V/1,5Ah HT Ni-Cd
601214830	B-941/HT	Battery 4,8V/3Ah Ni-Cd
923071000	GR-71	Set of batteries Ni-Cd 8,4V/1,5Ah
923072000	GR-72	Set of batteries Ni-Cd 8,4V/3Ah
923081000	GR-81	Set of batteries Ni-Cd 6V/1,5Ah
923082015	GR-82	Set of batteries Ni-Cd 6V/3Ah

# CONVERTERS FOR LED LUMINARIES



PROGRAMMABLE COMMON LED LUMINAIRE TO EMERGENCY LED LUMINARY CONVERTER 4,8V 1,5Ah/3Ah (LED volt output 12-58V DC / batteries are not included)

CODE	TYPE					
960110700	GR-1107/60V*	IP20	4,8V / 1,5 / 3Ah	1,5 or 3 h	4,75W/5VA	135 gr.

PROGRAMMABLE COMMON LED LUMINAIRE TO EMERGENCY LED LUMINARY CONVERTER 220-240V AC/ 50-60Hz (LED volt output 12-58V DC with capability to connect 4,8V/1,5 Ah or 3Ah battery)

CODE	TYPE					
960110701	GR-1107/60V/B-973/HT*	IP20	4,8V / 1,5Ah	1,5	4,75W/5VA	391,5 gr.
960110702	GR-1107/60V/B-941/HT*	IP20	4,8V / 3Ah	3 h	4,75W/5VA	477 gr.

PROGRAMMABLE COMMON LED LUMINAIRE TO EMERGENCY LED LUMINARY CONVERTER 4,8V 1,5Ah/3Ah (LED volt output 50-100V DC / batteries are not included)

CODE	TYPE					
960110705	GR-1107/100V	IP20	4,8V / 1,5Ah / 3Ah	1,5 or 3 h	4,75W/5VA	135 gr.

PROGRAMMABLE COMMON LED LUMINAIRE TO EMERGENCY LED LUMINARY CONVERTER 4,8V 1,5Ah/3Ah (LED volt output 50-100V DC)

CODE	TYPE					
960110706	GR-1107/100V/B-973/HT	IP20	4,8V / 1,5Ah	1,5	4,75W/5VA	391 gr.
960110707	GR-1107/100V/B-941/HT	IP20	4,8V / 3Ah	3 h	4,75W/5VA	477 gr.

PROGRAMMABLE COMMON LED LUMINAIRE TO EMERGENCY LED LUMINARY CONVERTER 4,8V 1,5Ah

CODE	TYPE					
960110710	GR-1107/100V/B-973/HT/3H	IP20	4,8V / 1,5Ah	default 3h	4,75W/5VA	392 gr.

## Dimensions

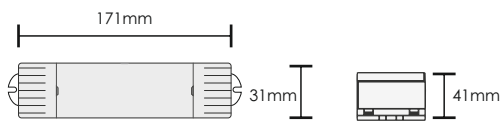

## BATTERIES

CODE	TYPE	DESCRIPTION
601214815	B-973/HT	Battery 4,8V/1,5Ah HT Ni-Cd
601214830	B-941/HT	Battery 4,8V/3Ah Ni-Cd



# ADDRESSABLE LIGHT

## GR-6500 Addressable panel

- Up to 250 addressable emergency luminaires can be connected
- Inhibit function for all luminaires
- Single Luminaire Monitoring: monitors the control circuit, the light source (ledstripe) and the battery of each luminaire separately
- 16 zones
- Capability for connecting several panels on an ethernet network
- The programming, control and testing of the system can be done using a web browser (Internet Explorer, Mozilla Firefox, Chrome)





KM640086  
BS EN 62034





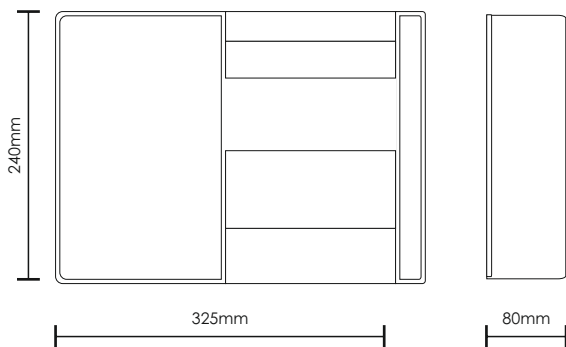

\*They have BSI certification

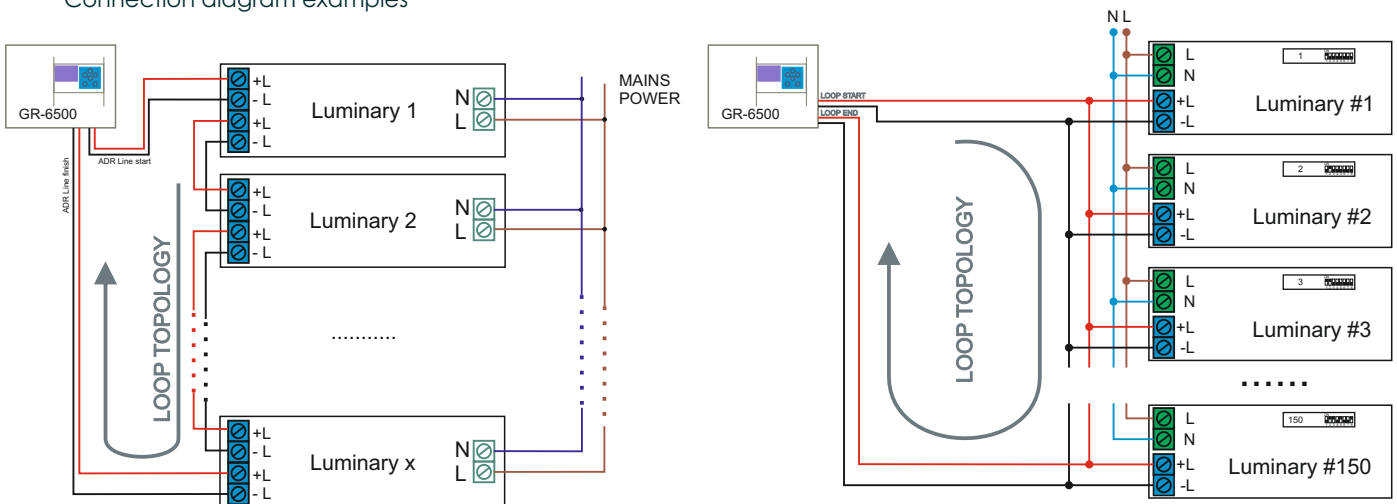
### Dimensions



### Connection diagram examples



CODE	TYPE	DESCRIPTION		 Pb				 kg
923650001	GR-6500*	Addressable panel	IP30	12V / 7Ah	>3h	25W / 35 VA	-	1605,5 gr.



ACCESSORIES				ON DEMAND	 kg
CODE	TYPE	DESCRIPTION			
923607900	GR-6079	Addressable module for LED GR-1107xx and fluorescent lamp converters GR-1004xx		✓	31 gr.
923853000	GR-8530	Network Ethernet adaptor		✓	154 gr.



GR-6079



GR-8530

## GR-6500 Addressable panel

- Up to 250 addressable emergency luminaires
- Inhibit function for all luminaires
- 16 zones
- Ethernet connectivity
- The programming, control and testing of the system can be done using a web browser (Internet Explorer, Mozilla Firefox, Chrome)
- 25W / 35VA max. power consumption
- 12V / 7Ah battery
- 3h autonomous duration

### Hardware related specifications:

- Up to 250 addressable luminaires in total (150 per loop)
- 4 monitored outputs dedicated for connecting the address communication lines that can be connected with 3 methods:
  - a. 2 loops (2 circular connections of address communication lines, with maximum 150 addressable luminaires per loop) – loop connection is always recommended
  - b. 4 independent lines or star connections (50 devices maximum per line) – only for smaller/shorter cable runs
  - c. Combined (1 loop + 2 independent lines) – flexible solution
- LED indications for operating modes, tests, faults, other
- LCD backlit display capable of multiple line text, with 4 informational sections in main screen (mode, status, luminary status, time/date)
- Easy to use keypad
- 220-240VAC/50-60Hz mains input power supply, with 25VA power consumption
- 12V/7Ah lead-acid battery for backup operation (>3h duration)
- Relay contacts for Operation / Emergency / Fault state that can be used as an input for other safety or informative equipment
- Polycarbonate ABS casing, IP 30

### Firmware related specifications:

- Constant monitoring of emergency lighting fittings with live view of events/faults
- 16 zones for grouping addressable luminaires, capable of performing test per zone
- Log of the latest 250 events on the system
- Programmable function test (lamp) that can run repeatedly (every day, every weekday, every weekend, etc) on a specific time.
- Programmable capacity test that can run 1 or 2 times per year on a specific date and time.
- Automatic scanning and registering all found addressable luminaires
- Option to disable segments

### Other specifications:

- Ethernet network connectivity (with card GR-8530 – optional), that provides remote monitoring and control of the GR-6500 panel, over a local area network, via a common web browser (Firefox, Chrome, Opera, etc).
- USB communication port, that can be used to transfer a configuration file to or from the PC Software "GR-6500", where the user can easily perform settings, set devices names and keep backup files. Can also be used for possible future firmware upgrades.

# ADDRESSABLE OLYMPUS LIGHT



CODE	TYPE	IMAGE	ST	M	NM	Water	Battery	Time	Wattage	Emergency	Weight
923100401	OLY-1004/WP/ADR HIGH LUMINOCITY	1	✓	✓	✓	IP65	3,6V/3Ah Ni-Cd	1h/3h/8h	4,5W/4,7VA	300/350 300/295 300/95lm	958 gr.
923100404	OLY-1004/ADR HIGH LUMINOCITY	1	✓	✓	✓	IP42	3,6V/3Ah Ni-Cd	1h/3h/8h	4,5W/4,7VA	300/350 300/295 300/95lm	958 gr.
923102401	OLY-1024/WP/ADR HIGH LUMINOCITY	2	✓	✓	✓	IP65	3,6V/3Ah Ni-Cd	1h/3h/8h	4,6W/4,8VA	300/380 300/320 300/100lm	953 gr.
923102404	OLY-1024/ADR HIGH LUMINOCITY	2	✓	✓	✓	IP42	3,6V/3Ah Ni-Cd	1h/3h/8h	4,6W/4,8VA	300/380 300/320 300/100lm	953 gr.

## Dimensions

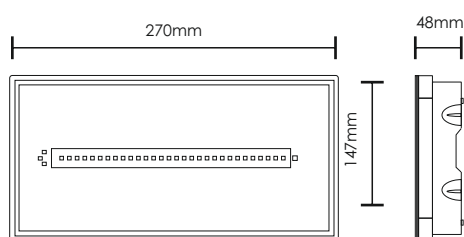

## Photometric

### OLY-500/1004

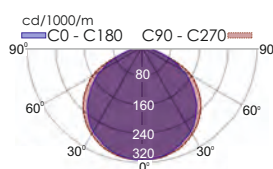

### OLY-1024

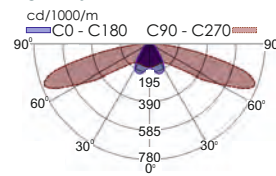

# ADDRESSABLE WEATHER LIGHT

# ADDRESSABLE LINEAR LIGHT



GR-19XX

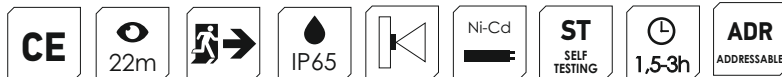

KLIN-20



CODE	TYPE	IMAGE	ST	M	NM	Water	Battery	Time	Power	Mains/Emergency	kg
923193804	GR-1938/15L/ADR*	1	✓	✓	✓	IP65	3,6V/600mAh Ni-Cd	1,5 h	3,4W/3,8VA	105/105 lm	738 gr.
923193805	GR-1938/30L/ADR*	1	✓	✓	✓	IP65	3,6V/1,5Ah Ni-Cd	1,5 h	4,5W/4,9VA	210/210 lm	811 gr.
923193904	GR-1939/15L/ADR*	1	✓	✓	✓	IP65	3,6V/1,5Ah Ni-Cd	3 h	3,3W/3,7VA	105/105 lm	818 gr.
923193905	GR-1939/30L/ADR*	1	✓	✓	✓	IP65	3,6V/3Ah Ni-Cd	3 h	5,3W/5,6VA	210/210 lm	890 gr.
922502058	KLIN-20/ST/ADR*	2	✓	✓	✓	IP54	3,6V/1,5Ah Ni-Mh	1-3-8 h	3,9W/4,4VA	80/250 80/77 80/12lm	418 gr.

## Dimensions

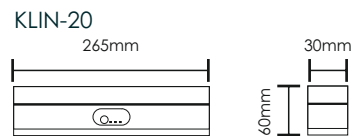
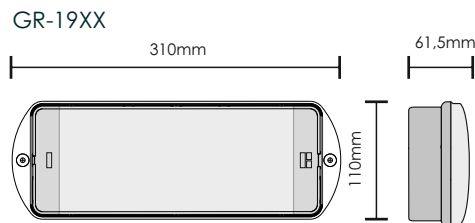

## Photometric

GR-1935\_15L

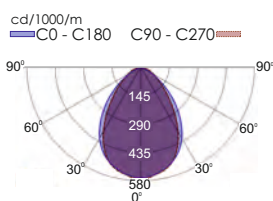

GR-1938-30L

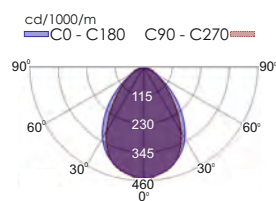

GR-1938-4P

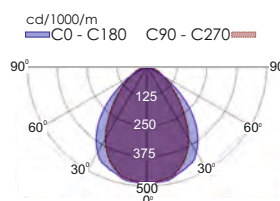

GR-1938-6P

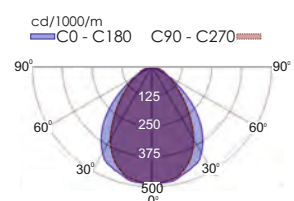

► For accessories & mounting methods go to pages 24-25  
 ► For spacing tables go to pages 166-168

► For accessories & mounting methods go to page 37  
 ► For spacing tables go to page 171



# ADDRESSABLE ECO LIGHT



**ZLD-xx**    ZLD-28    ZLD-34    ZLD-44

**CE**    16m    30m    38m       3h    IP40    **ST** SELF TESTING    **Ik07**    Ni-Mh             **ADR** ADDRESSABLE

**PLD-28**

**CE**    26m       3h    IP44    **ST** SELF TESTING    **Ik09**    Ni-Mh             **ADR** ADDRESSABLE   

CODE	TYPE	IMAGE	ST	M	NM					Mains/ Emergency	kg
922502862	ZLD-28/EM/ADR*	1	✓	✓	✓	IP40	3,6V/1,5Ah Ni-Mh	3 h	3,8W/6,5VA	125/125 lm	1021 gr.
922503467	ZLD-34/EM/ADR*	1	✓	✓	✓	IP40	3,6V/1,5Ah Ni-Mh	3 h	4W/6,7VA	145/125 lm	1401 gr.
922504458	ZLD-44/EM/ADR	1	✓	✓	✓	IP40	3,6V/1,5Ah Ni-Mh	3 h	4,3W/6,9VA	170/125 lm	1936 gr.
922502515	PLD-25/NiMh/M/ADR	2	✓	✓	✓	IP44	3,6V/1,5Ah Ni-Mh	3 h	4W/4,4 VA	90/100 lm	1084 gr.

## Dimensions

### ZLD-xx

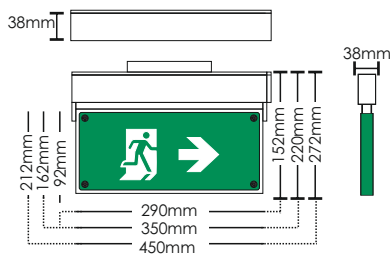

### PLD-25

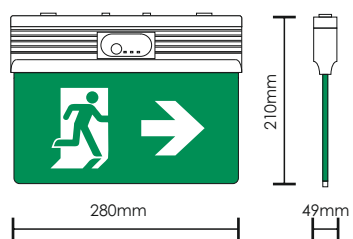

# ADDRESSABLE LOUNGELIGHT



CODE	TYPE	IMAGE	ST	M	NM	IP	Battery	Time	Power	Mains/Emergency	Weight
922028026	SLD-28/DZ/M/ADR	2	✓	✓	✓	IP30	3,6V/1,5Ah Ni-Mh	3 h	2,7W/3,9VA	100/100 lm	943 gr.
922034025	SLD-34/DZ/M/ADR	2	✓	✓	✓	IP30	3,6V/1,5Ah Ni-Mh	3 h	3W/4,2VA	125/125 lm	1298 gr.
922044017	SLD-44/DZ/M/ADR	2	✓	✓	✓	IP30	3,6V/1,5Ah Ni-Mh	3 h	3W/4,2VA	125/125 lm	1751 gr.
922028027	SLD-28/SP/M/ADR	1	✓	✓	✓	IP30	3,6V/1,5Ah Ni-Mh	3 h	2,7W/3,9VA	100/100 lm	1053 gr.
922034026	SLD-34/SP/M/ADR	1	✓	✓	✓	IP30	3,6V/1,5Ah Ni-Mh	3 h	3W/4,2VA	125/125 lm	1388 gr.
922044018	SLD-44/SP/M/ADR	1	✓	✓	✓	IP30	3,6V/1,5Ah Ni-Mh	3 h	3W/4,2VA	125/125 lm	1970 gr.

## Dimensions

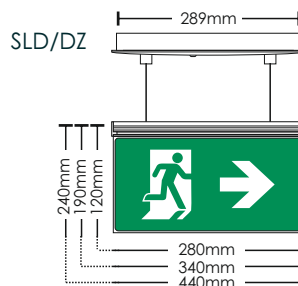
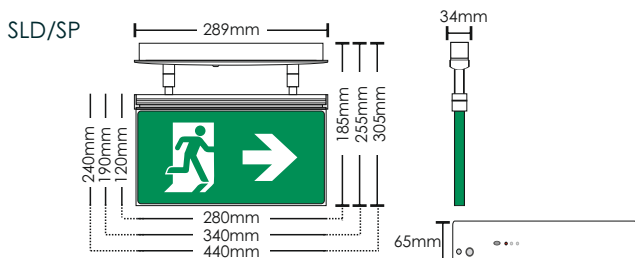

# ADDRESSABLE ECO LIGHT



CODE	TYPE	IMAGE	ST	M	NM	IP	Battery	Time	Power	Mains/Emergency	kg
922502204	KLD-22/ST/ADR*	1	✓	✓	✓	IP54	3.5W/4VA Ni-Cd	1-3-8 h	3.9W/4.4VA	80/250 80/110 80/15m	872 gr.
922503054	KLD-30/ST/ADR*	2	✓	✓	✓	IP54	3.5W/4VA Ni-Cd	1-3-8 h	3.9W/4.4VA	80/250 80/110 80/15m	1358 gr.

## Dimensions

KLD-22

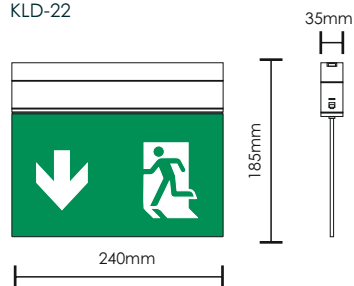

KLD-30

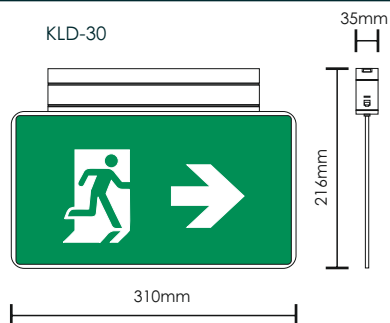

# ADDRESSABLE ECO LIGHT



CODE	TYPE	ST	M	NM	Water	Battery	Time	Power	Mains/Emergency	Weight
922502054	KLR-20/ST/ADR*	✓	✓	✓	IP54	3.6V/1.5Ah Ni-Cd	1-3-8 h	3,9W/4,4VA	80/250 80/110 80/15m	872 gr.

## Dimensions

KLR-20

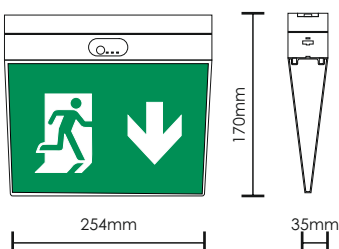

# ADDRESSABLE BAU LIGHT

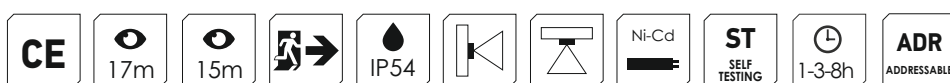

CODE	TYPE	ST	M	NM	IP	Battery	Life	Power	Mains/Emergency	kg
923750004	GR-750/ST/HP/LL/ADR LOW LUMINOSITY	✓	✓	✓	IP54	3,6V/1,5Ah Ni-Cd	1-3-8 h	4,1W/4,3VA	270/300 270/150 270/30m	950 gr.
923751003	GR-751/ST/LP/LL/ADR LOW LUMINOSITY	✓	✓	✓	IP54	3,6V/1,5Ah Ni-Cd	1-3-8 h	4,1W/4,3VA	270/300 270/150 270/30m	950 gr.
923752003	GR-752/ST/HP/HL/ADR HIGH LUMINOSITY	✓	✓	✓	IP54	3,6V/3Ah Ni-Cd	1-3-8 h	4,5W/4,7VA	270/350 270/280 270/90m	1023 gr.
923753003	GR-753/ST/LP/HL/ADR HIGH LUMINOSITY	✓	✓	✓	IP54	3,6V/3Ah Ni-Cd	1-3-8 h	4,5W/4,7VA	270/350 270/280 270/90m	1023 gr.

## Dimensions

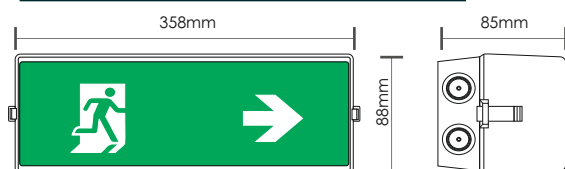

**LP:** Low Profile / deep transparent hood

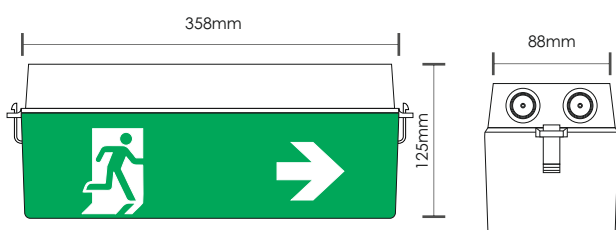

**HP:** High Profile/ High opal hood

# ADDRESSABLE LED LIGHT BOX



CODE	TYPE	ST	M	NM	IP	Battery	Time	Power	Mains/Emergency	Weight
923026007	LLB-26/90/ADR	✓	✓	✓	IP44	4,8V/1,2Ah Ni-Mh	1,5 h	6W/6,4VA	230/300 lm	1083 gr.
923026008	LLB-26/180/ADR	✓	✓	✓	IP44	4,8V/1,2Ah Ni-Mh	3 h	6W/6,4VA	230/123 lm	1083 gr.
923040006	LLB-40/90/ADR	✓	✓	✓	IP44	4,8V/1,2Ah Ni-Mh	1,5 h	7W/7,4VA	370/300 lm	1785 gr.
923040007	LLB-40/180/ADR	✓	✓	✓	IP44	4,8V/2,4Ah Ni-Mh	3 h	7W/7,4VA	370/300 lm	1892 gr.
923064006	LLB-64/90/ADR	✓	✓	✓	IP44	4,8V/2Ah Ni-Mh	1,5 h	9,3W/9,8VA	600/500 lm	2456 gr.
923064007	LLB-64/180/ADR	✓	✓	✓	IP44	4,8V/4Ah Ni-Mh	3 h	9,3W/9,8VA	600/500 lm	3383 gr.

## Dimensions

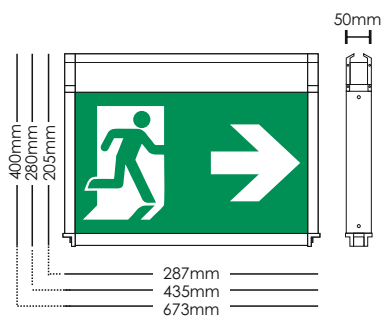

# ADDRESSABLE SPOT LIGHT



\*They have BSI & CNBOP-PIB certifications



CODE	TYPE	ST	M	NM	Water	Battery	Time	Power	Mains/Emergency	kg
923291003	GR-291/ADR*	✓	—	✓	IP40	4,8V/1,2Ah Ni-Mh	1,5 h	3,7W/4,1VA	270 lm	542 gr.
923293001	GR-293/ADR*	✓	—	✓	IP40	4,8V/1,2Ah Ni-Mh	3 h	3,7W/4,1VA	160 lm	542 gr.
923290003	GR-290/ADR*	✓	—	✓	IP40	4,8V/1,2Ah Ni-Mh	1,5 h	3,7W/4,1VA	270 lm	542 gr.
923292001	GR-292/ADR*	✓	—	✓	IP40	4,8V/1,2Ah Ni-Mh	3 h	3,7W/4,1VA	160 lm	542 gr.
923291010	GR-291/ADR/WP	✓	—	✓	IP65	4,8V/1,2Ah Ni-Mh	1,5 h	3,7W/4,1VA	270 lm	542 gr.
923293006	GR-293/ADR/WP	✓	—	✓	IP65	4,8V/1,2Ah Ni-Mh	3 h	3,7W/4,1VA	160 lm	542 gr.
923290009	GR-290/ADR/WP	✓	—	✓	IP65	4,8V/1,2Ah Ni-Mh	1,5 h	3,7W/4,1VA	270 lm	542 gr.
923292006	GR-292/ADR/WP	✓	—	✓	IP65	4,8V/1,2Ah Ni-Mh	3 h	3,7W/4,1VA	160 lm	542 gr.
923292008	GR-292/M/HL/ADR	✓	—	✓	IP20	4,8V/4Ah Ni-Mh	3 h	4,9W/5,2VA	330 lm	923 gr.
923293008	GR-293/M/HL/ADR	✓	—	✓	IP40	4,8V/4Ah Ni-Mh	3 h	4,9W/5,2VA	330 lm	923 gr.

## Dimensions

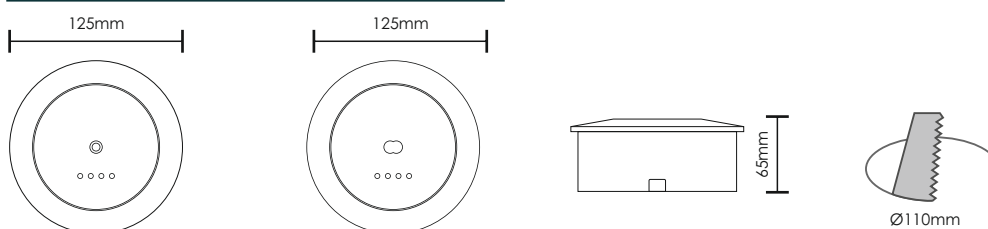

## Photometric

GR-291/ADR & GR-293/ADR

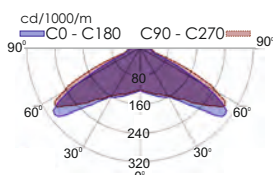

GR-290/ADR & GR-292/ADR

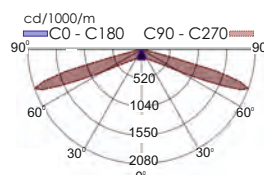

# ADDRESSABLE TETRAGONO LIGHT



CODE	TYPE	ST	M	NM	Waterproof	Battery	Runtime	Power	Emergency	Weight
923490002	GR-490/WP/ADR	✓	—	✓	IP65	3,9W / 4,4VA	1,5 h	3,9W/4,4VA	280lm	854 gr.
923491002	GR-491/WP/ADR	✓	—	✓	IP65	3,9W / 4,4VA	1,5 h	3,9W/4,4VA	280lm	854 gr.
923492002	GR-492/WP/ADR	✓	—	✓	IP65	3,9W / 4,4VA	3 h	3,9W/4,4VA	140lm	854 gr.
923493002	GR-493/WP/ADR	✓	—	✓	IP65	3,9W / 4,4VA	3 h	3,9W/4,4VA	140lm	854 gr.
923490003	GR-490/ADR	✓	—	✓	IP42	3,9W / 4,4VA	1,5 h	3,9W/4,4VA	280lm	854 gr.
923491003	GR-491/ADR	✓	—	✓	IP42	3,9W / 4,4VA	1,5 h	3,9W/4,4VA	280lm	854 gr.
923492003	GR-492/ADR	✓	—	✓	IP42	3,9W / 4,4VA	3 h	3,9W/4,4VA	140lm	854 gr.
923493003	GR-493/ADR	✓	—	✓	IP42	3,9W / 4,4VA	3 h	3,9W/4,4VA	140lm	854 gr.

## Dimensions

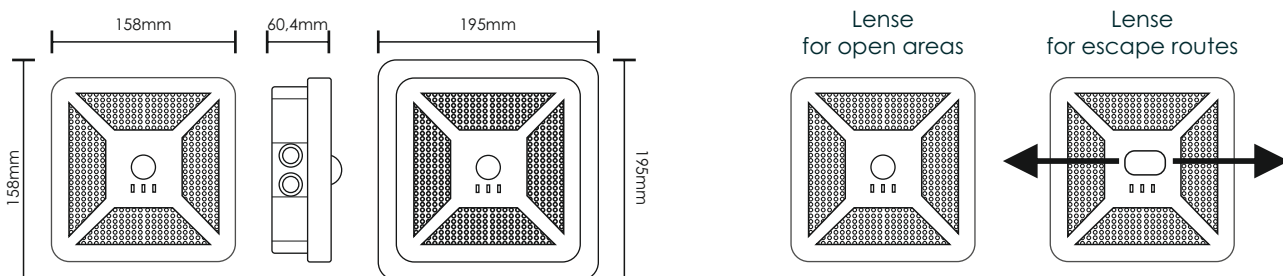

## Photometric

GR-4x0, GR-4x2

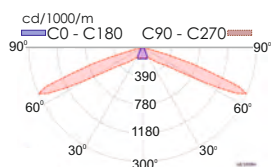

GR-4x1, GR-4x3

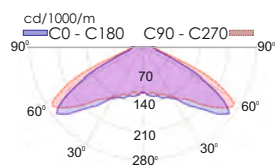

► For accessories & mounting methods go to page 76. For spacing tables go to pages 178-179





# ADDRESSABLE POWER LIGHT



CODE	TYPE	IMAGE	ST	M	NM	Water	Battery	Clock	Light source	Light output	kg
923037007	GRL-37/90/ADR*	1	✓	—	✓	IP42	12V/7Ah Pb	1,5 h	2x6P Leds	3200 lm	4360 gr.
923037008	GRL-37/180/ADR*	1	✓	—	✓	IP42	2x12V/7Ah Pb	3 h	2x6P Leds	3200 lm	6560 gr.
923029013	GRL-29/ADR	1	✓	—	✓	IP42	12V/7Ah Pb	3 h	2x84 Leds	1760 lm	3684 gr.
923037009	GRL-37/90/WP/ADR*	2	✓	—	✓	IP65	12V/7Ah Pb	1,5 h	2x6P Leds	3200 lm	4616 gr.
923037010	GRL-37/180/WP/ADR*	2	✓	—	✓	IP65	2x12V/7Ah Pb	3 h	2x6P Leds	3200 lm	6677 gr.
923029012	GRL-29/WP/ADR	2	✓	—	✓	IP65	12V/7Ah Pb	3 h	2x84 Leds	1760 lm	3915 gr.

## Dimensions

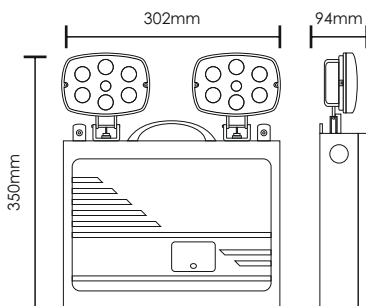



phos<sup>4.0</sup>  
software



# WIRELESS EMERGENCY LIGHTING SYSTEM



The Phos 4.0 is the latest offering on wireless emergency lighting monitoring systems by Olympia Electronics. It is based on encrypted wireless communications between luminaires, offering complete monitoring of all connected luminaires with robust security from unwanted access.

The Phos 4.0 software enables the user to monitor and control up to 16 wireless gateways for a total of 3200 devices from a centralized location. The software offers complete monitoring capabilities of all connected devices, a complete installation

graphical view, BMS connectivity via Modbus TCP, and robust notifications options.

The system preserves the ease of installation offered by self-contained luminaires, avoiding the need for specialized installation crews, as each luminaire only requires a local power supply. Furthermore, each wireless device operates as a separate node, receiving and transmitting the signal to neighboring devices, thus enabling the network to self-heal and bypass any malfunctioning nodes.





## Dimensions

GR-7610/V2

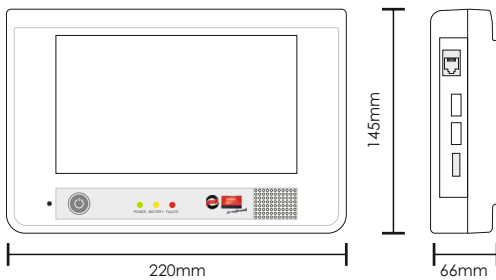

Description	GR-7610/V2 i-OLEG Olympia Electronics LumiGate
Code	923761001
Consumption	23VA
CPU	quad-core 1.8GHz
RAM / FLASH MEMORY	2GB / 32GB
Display	7" capacitive touch IPS display (1024x600)
Battery	SPA 6V/1.3Ah (Lead acid)
Duration	1h
Mounting	Wall or desktop

The GR-7610/V2 i-OLEG is the standalone control panel version of the wireless emergency lighting system. The i-OLEG is equipped with a 7" control touch screen and the backup battery offers 1h autonomy. The GR-7610/V2 comes with the Standard version of "Phos4.0" software pre-installed and can support up to 2 USB Gateways (GR-7607/V2 or GR-7605/V2).

### Features:

- Status indication LEDs (Power, Battery, Fault)
- 1x Ethernet connection (Rj45)
- 2x USB connection
- 1x HDMI connection
- WiFi Connection (802.11 b/g/n)
- System buzzer (alert on system fault)

## Mounting methods

### Wall



### Desktop



# WIRELESS EMERGENCY LIGHTING MONITORING



**The Phos 4.0 is an advanced wireless emergency lighting ecosystem, designed to satisfy all safety demands of a building while providing the ease of installation and maintenance of a modern, centralized wireless system.**

The building block of the Phos 4.0 wireless system is the Wireless Gateway. Each Wireless Gateway can monitor up to 200 wireless devices, with the wireless connection between the devices established via a fast, mesh-type network, operating at 868 MHz, either directly or through another wireless device. The Wireless Gateway is available in three versions, USB, Wifi, and Ethernet, offering a wide array of connectivity options.

The Phos 4.0 software is the brains of the wireless system. The software is the one responsible for monitoring the connected wireless devices, performing preprogrammed tests, and notifying the results to the end-user via email or Modbus to a central BMS.

The Phos4.0 software has two separate versions: the Advanced and the Standard versions.

The Advanced version of the Phos 4.0 software offers the complete capabilities of the system, as it provides the user the ability to independently set up each Gateway as well as allowing the connection of up to 16 Gateways to a single central PC.

The Standard version of the Phos 4.0 software comes pre-installed on the GR-7610/V2 i-OLEG tablet. The GR-7610/V2 i-OLEG tablet can accept up to two USB

Gateways, which are automatically recognized by the software, thus greatly facilitating and simplifying the installation and commissioning procedures.

- ▶ Supports multiple Gateway versions (USB/Wifi/Ethernet)
- ▶ Multiple repeater support for remote system monitoring and control (Advance Version)
- ▶ Up to 16 Gateways (Advance Version)
- ▶ 200 Devices per Gateway
- ▶ 16 programmable digital zones
- ▶ Central Information Screen
- ▶ Multiple Floor plans with active device icons
- ▶ Current Events View
- ▶ Event Logging
- ▶ Email report
- ▶ Automated device search and installation
- ▶ Easy device separation in different gateway networks
- ▶ Automatic device categorization for instantaneous setup and updating
- ▶ Immediate information for each connected device

## Typical Phos 4.0 system layout.

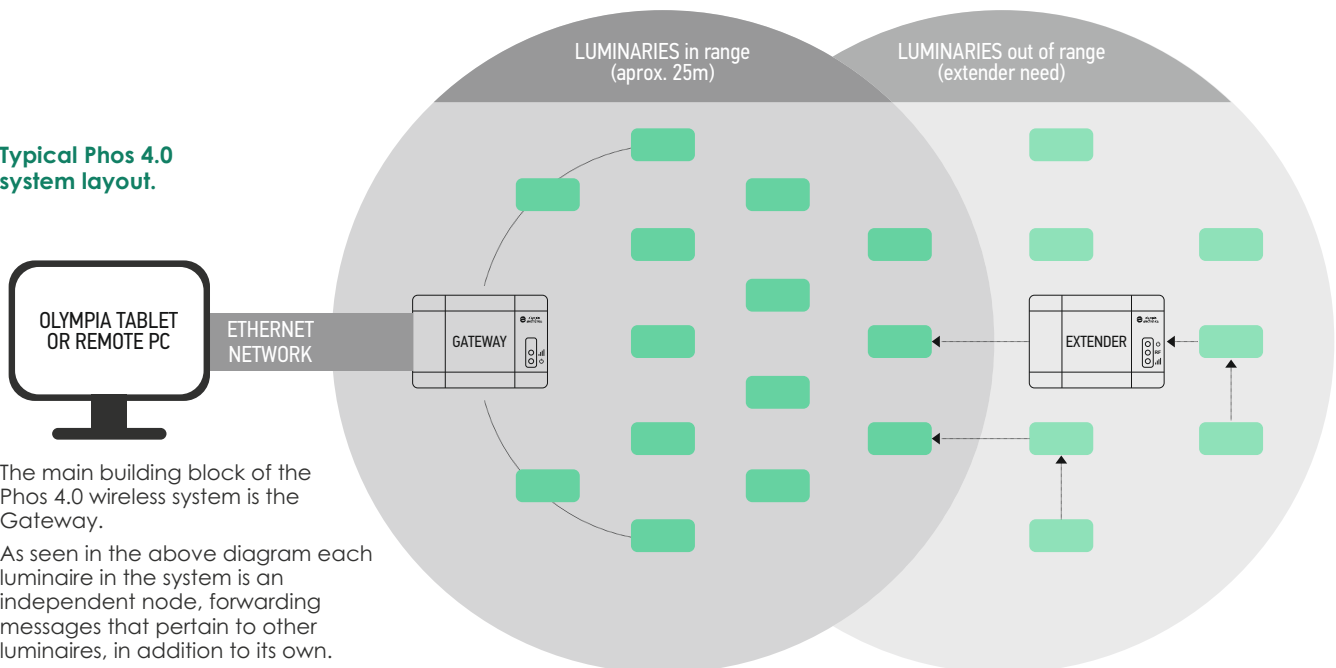

The main building block of the Phos 4.0 wireless system is the Gateway.

As seen in the above diagram each luminaire in the system is an independent node, forwarding messages that pertain to other luminaires, in addition to its own.

The Extender enables communication with devices beyond the normal range of the nodes (20m-25m).

# WIRELESS LIGHTING MONITORING



1  
GR-7606/V2



2  
GR-7607/V2

## Dimensions

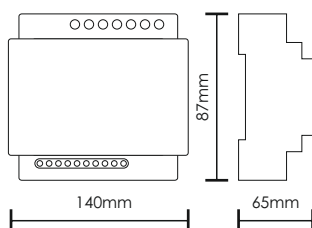

<b>Description</b>	GR-7606/V2 In/Out Wireless Unit
--------------------	------------------------------------

<b>Code</b>	923760601
-------------	-----------

<b>Consumption in standby mode</b>	6.1mA / 34.2 - 58.3mA
------------------------------------	-----------------------

<b>Outputs</b>	2, relay 30V/1 $\frac{1}{2}$ , 125V/0.5A
----------------	--

The **GR-7606/V2** Wireless I/O Unit is a device that can be used to bridge another (safety or monitoring) system with the wireless emergency lighting. It implements 2 relay outputs (dry-contact) that are programmable and can be armed in case of emergency, fault, test. The 2 inputs are also programmable and can be used to run a test procedure (lamp or battery).

<b>Description</b>	GR-7607/V2 USB gateway
<b>Code</b>	923760700
<b>Max. wireless devices capacity</b>	200
<b>Tx/Rx frequency range</b>	868.150 - 868.450MHz
<b>Tx power</b>	11dBm



<b>Description</b>	GR-6600/WL/V2 Spare wireless adapter for emergency luminaires	GR-6601/WL/V2 Spare wireless adapter for emergency luminaires (with SMA connector)
<b>Code</b>	923660007	923660100

# WIRELESS LIGHTING MONITORING



## Dimensions

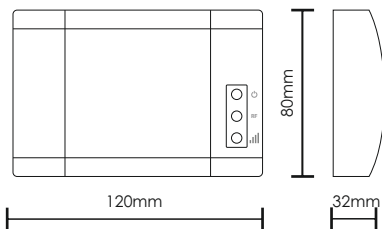

Description	GR-7603/V2 Ethernet/Wifi Gateway	GR-7604/V2 Network Extender
Code	923760300	923760401
Consumption	2VA	1,5VA
Max. Wireless Device Capacity	200	
Tx power	11dBm	11dBm
Wi-Fi Protocol	802.11 b/g/n	
Tx/Rx frequency range		868 - 870MHz

**The GR-7603/V2** Ethernet + Wifi Gateway is a Gateway (master) device for a wireless emergency lighting network. It provides Wi-Fi (WPA/PSK or WPS) and Ethernet connection options, with dynamic (DHCP) or static Ipv4 addressing, to be connected to the local network and communicate with the master control application (Phos4.0). The configurations are applied through a simple webpage (connect via mini Access Point). Capable of controlling up to 200 wireless devices. It is supplied via mains power (220-240V/50-60Hz) without self-contained backup operation. For uninterruptible operation a UPS power line must be used. Works exclusively with 'Advanced' version of "Phos4.0" software application. (with the use of PC).

**GR-7604/V2** Network Extender is a signal range extension device, thus a signal repeater. It re-transmits received messages, similarly to wireless emergency luminaires (20~25m range). It is supplied via mains power (220-240V/50-60Hz) without self contained backup operation. For uninterruptible operation a UPS power line must be used.

## Dimensions

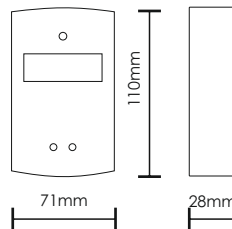

Description	GR-7605/V2 Rssi tester / USB gateway
Code	923760501
Power supply	4.9V to 5.1V (USB)
Consumption	0.7W / 0.14A (max) 3.6V / 240mAh NiMH (rechargeable, non-replaceable)
Battery	

**GR-7605/V2** RSSI Tester / USB Gateway main functionality is to be used as a handheld signal level measuring device during installation of wireless emergency lighting, to check signal coverage in a position, before installing a device. Can alternatively be used as a USB Gateway, a Spectrum Analyzer or a Manual Installation Tool (along with the 'Wireless Installation Tool' application).



# WIRELESS EASY LIGHT



CODE	TYPE	IMAGE	ST	M	NM	IP	Battery	Time	Power	Mains/Emergency	kg
923370000	GR-370/LL/WL LOW LUMINOSITY*	1	✓	✓	—	IP40	3.6V/1500mAh Ni-Cd	1h/3h/8h	4.4W/4.6VA	300/280 300/150 300/35lm	-
923371000	GR-371/HL/WL HIGH LUMINOSITY*	1	✓	✓	—	IP40	3.6V/3000mAh Ni-Cd	1h/3h/8h	5.3W/5.5VA	300/330 300/280 300/90lm	-
923135002	GR-1350/LL/WL HIGH LUMINOSITY	2	✓	✓	—	IP40	3.6V/1500mAh Ni-Cd	1h/3h/8h	4.4W/4.6VA	300/280 300/150 300/35lm	-
923135100	GR-1351/HL/WL LOW LUMINOSITY	2	✓	✓	—	IP40	3.6V/3000mAh Ni-Cd	1h/3h/8h	5.3W/5.5VA	300/330 300/280 300/90lm	-

## Dimensions

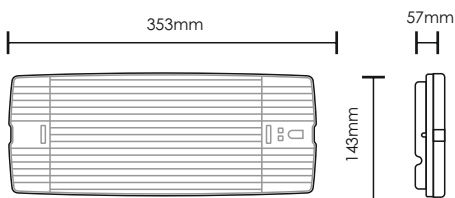

## Dimensions

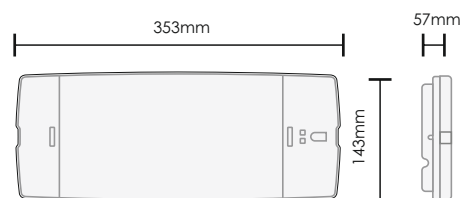

## Photometric

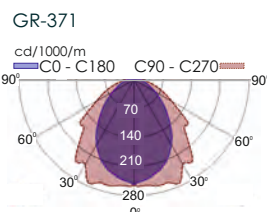

## Photometric

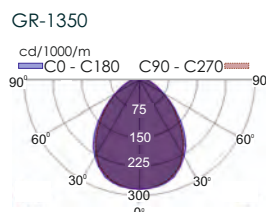

# WIRELESS OLYMPUS LIGHT



CODE	TYPE	IMAGE	ST	M	NM	IP	Battery	Time	Power	Mains/Emergency	kg
923100402	OLY-1004/WP/WL HIGH LUMINOCTY	1	✓	✓	✓	IP65	3,6V/3Ah Ni-Cd	1h/3h/8h	4,5W/4,7VA	300/350 300/295 300/95lm	958 gr.
923100405	OLY-1004/WL HIGH LUMINOCTY	1	✓	✓	✓	IP42	3,6V/3Ah Ni-Cd	1h/3h/8h	4,5W/4,7VA	300/350 300/295 300/95lm	958 gr.
923102402	OLY-1024/WP/WL HIGH LUMINOCTY	2	✓	✓	✓	IP65	3,6V/3Ah Ni-Cd	1h/3h/8h	4,6W/4,8VA	300/380 300/320 300/100lm	953 gr.
923102405	OLY-1024/WL HIGH LUMINOCTY	2	✓	✓	✓	IP42	3,6V/3Ah Ni-Cd	1h/3h/8h	4,6W/4,8VA	300/380 300/320 300/100lm	953 gr.

## Dimensions

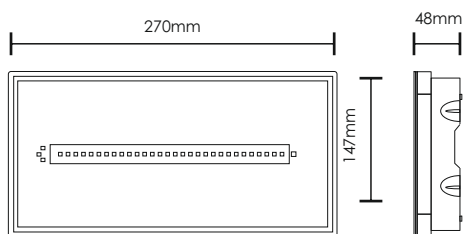

## Photometric

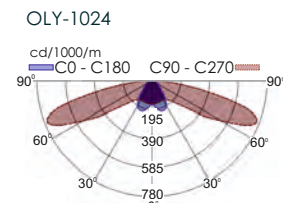
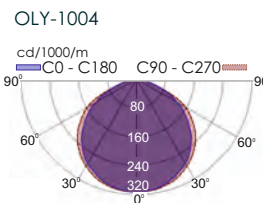

# WIRELESS WEATHER LIGHT

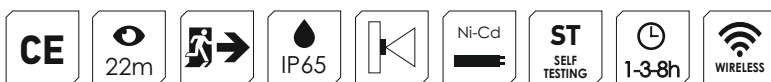

CODE	TYPE	ST	M	NM	IP	Battery	Time	Power	Mains/Emergency
923195000	GR-1950/LL/WL LOW LUMINOSIT	✓	✓	✓	IP65	3.6V/1500mAh	1h/3h/8h	4.4W/4.6VA	300/280 300/150 300/35m
923195100	GR-1951/HL/WL HIGH LUMINOSITY	✓	✓	✓	IP65	3.6V/3000mAh	1h/3h/8h	5.3W/5.5VA	300/330 300/280 300/90m

## Dimensions

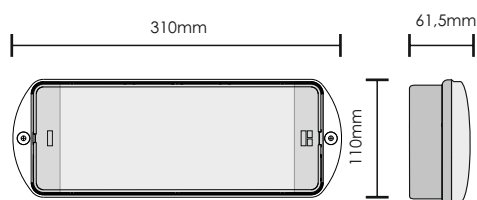

## Photometric

GR-1950 & GR-1951

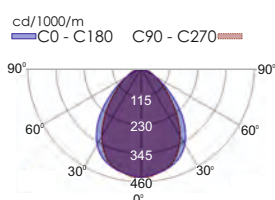

# WIRELESS LINEAR LIGHT



CODE	TYPE	ST	M	NM	Water Drop	Battery	Clock	Lightning Bolt	Mains/Emergency	kg
922502059	KLIN-20/ST/ML	✓	✓	✓	IP54	3,6V/1,5Ah Ni-Mh	1-3-8 h	3,9W/4,4VA	80/250 80/77 80/12m	418 gr.

## Dimensions

KLIN-20

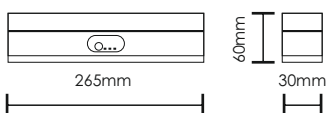

# WIRELESS BAU LIGHT

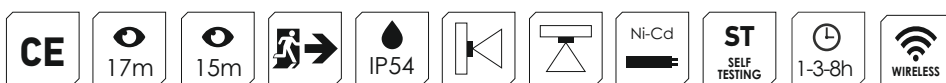
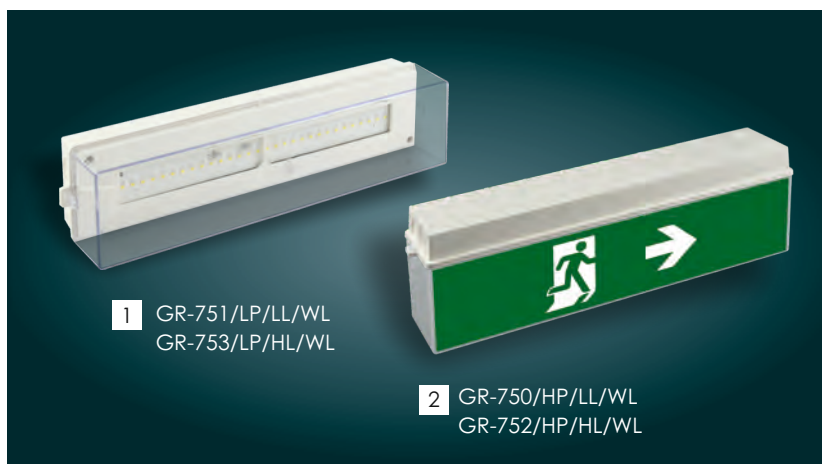

CODE	TYPE	ST	M	NM	IP	Battery	ST	Power	Mains/Emergency	kg
923750005	GR-750/ST/HP/LL/WL LOW LUMINOSITY	✓	✓	✓	IP54	3,6V/1.5Ah Ni-Cd	1-3-8 h	4,1W/4,3VA	270/300 270/150 270/30m	884 gr.
923751004	GR-751/ST/LP/LL/WL LOW LUMINOSITY	✓	✓	✓	IP54	3,6V/1.5Ah Ni-Cd	1-3-8 h	4,1W/4,3VA	270/300 270/150 270/30m	884 gr.
923752004	GR-752/ST/HP/HL/WL HIGH LUMINOSITY	✓	✓	✓	IP54	3,6V/3Ah Ni-Cd	1-3-8 h	4,5W/4,7VA	270/350 270/280 270/90m	952 gr.
923753004	GR-753/ST/LP/HL/WL HIGH LUMINOSITY	✓	✓	✓	IP54	3,6V/3Ah Ni-Cd	1-3-8 h	4,5W/4,7VA	270/350 270/280 270/90m	952 gr.

## Dimensions

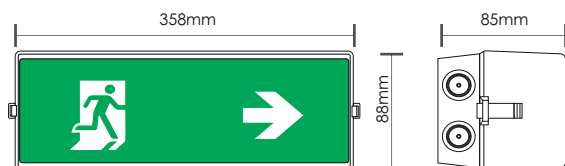

LP: Low Profile /deep transparent hood

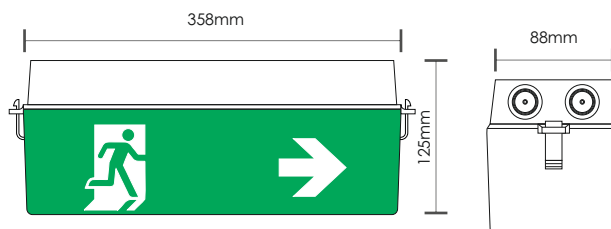

HP: High Profile/ High opal hood

# WIRELESS LED LIGHT BOX



LLB-26 LLB-40 LLB-64  
CE 26m 40m 64m → 3h IP44 ST SELF TESTING Ni-Mh ▶ ▶ WIRELESS

CODE	TYPE	ST	M	NM	IP	Battery	Time	Power	Mains/Emergency	kg
923026009	LLB-26/90/WL	✓	✓	✓	IP44	4,8V/1,2Ah Ni-Mh	1,5 h	6W / 6,4VA	230/300 lm	1085 gr.
923026010	LLB-26/180/WL	✓	✓	✓	IP44	4,8V/1,2Ah Ni-Mh	3 h	6W / 6,4VA	230/123 lm	1085 gr.
923040008	LLB-40/90/WL	✓	✓	✓	IP44	4,8V/1,2Ah Ni-Mh	1,5 h	7W / 7,4VA	370/300 lm	1787 gr.
923040009	LLB-40/180/WL	✓	✓	✓	IP44	4,8V/2,4Ah Ni-Mh	3 h	7W / 7,4VA	370/300 lm	1894 gr.
923064008	LLB-64/90/WL	✓	✓	✓	IP44	4,8V/2Ah Ni-Mh	1,5 h	9,3W / 9,8VA	600/500 lm	2458 gr.
923064009	LLB-64/180/WL	✓	✓	✓	IP44	4,8V/4Ah Ni-Mh	3 h	9,3W / 9,8VA	600/500 lm	3385 gr.

LLB-XX/O All the above models can be manufactured as one sided luminaries with aluminum backplate

## Dimensions

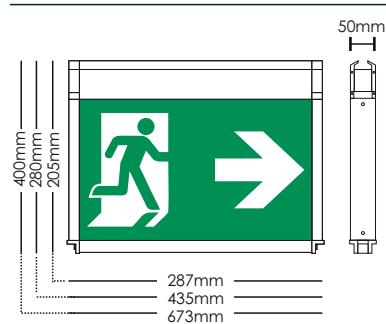

# WIRELESS ECO LIGHT



CODE	TYPE	IMAGE	ST	M	NM	IP	Battery	Time	Power	Mains/Emergency	kg
922502205	KLD-22/ST/WL	1	✓	✓	✓	IP54	3,6V/1,5Ah Ni-Cd	1-3-8 h	3,9W/4,4VA	80/250 80/110 80/15lm	872 gr.
922503055	KLD-30/ST/WL	2	✓	✓	✓	IP54	3,6V/1,5Ah Ni-Cd	1-3-8 h	3,9W/4,4VA	80/250 80/110 80/15lm	1358 gr.

## Dimensions

KLD-22

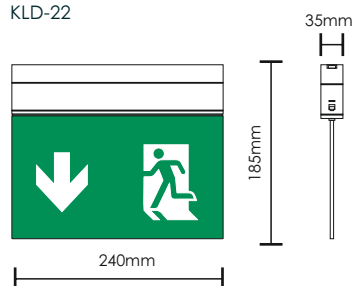

KLD-30

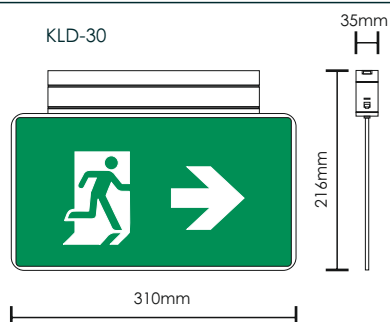

# WIRELESS ECO LIGHT



CODE	TYPE	IMAGE	ST	M	NM	IP	Battery	Life	Power	Mains/Emergency	Weight
922502055	KLR-20/ST/WL	1	✓	✓	✓	IP54	3,6V/1,5Ah Ni-Cd	1-3-8 h	3,5W/4VA	75/75 lm	872 gr.

## Dimensions

KLR-20

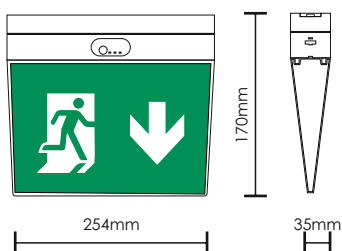



# WIRELESS ECO LIGHT



CODE	TYPE	ST	M	NM	IP	Battery	Time	Power	Light	Weight
922502516	PLD-25/NiMh/M/WL	✓	✓	✓	IP44	3,6V/1,5Ah Ni-Mh	3 h	4W/4,4 VA	90/100 lm	1086 gr.

## Dimensions

### ZLD-xx

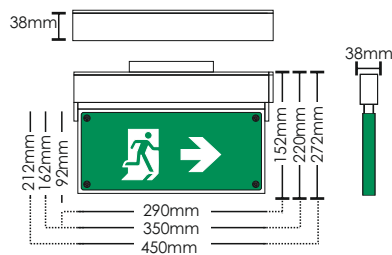

### PLD-25

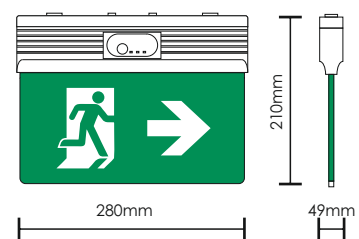

# WIRELESS LOUNGE LIGHT

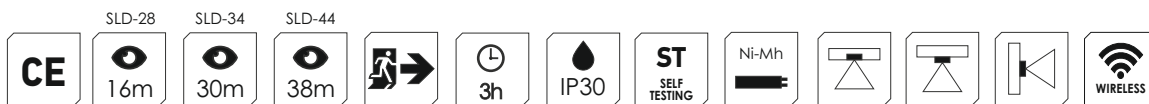

CODE	TYPE	IMAGE	ST	M	NM	IP	Battery	Time	Power	Mains/Emergency	Weight
922028028	SLD-28/DZ/M/WL	2	✓	✓	✓	IP30	3,6V/1,5Ah Ni-Mh	3 h	2,7W/3,9VA	100/100 lm	945 gr.
922034027	SLD-34/DZ/M/WL	2	✓	✓	✓	IP30	3,6V/1,5Ah Ni-Mh	3 h	3W/4,2VA	125/125 lm	1300 gr.
922044019	SLD-44/DZ/M/WL	2	✓	✓	✓	IP30	3,6V/1,5Ah Ni-Mh	3 h	3W/4,2VA	125/125 lm	1753 gr.
922028029	SLD-28/SP/M/WL	1	✓	✓	✓	IP30	3,6V/1,5Ah Ni-Mh	3 h	2,7W/3,9VA	100/100 lm	1055 gr.
922034028	SLD-34/SP/M/WL	1	✓	✓	✓	IP30	3,6V/1,5Ah Ni-Mh	3 h	3W/4,2VA	125/125 lm	1390 gr.
922044020	SLD-44/SP/M/WL	1	✓	✓	✓	IP30	3,6V/1,5Ah Ni-Mh	3 h	3W/4,2VA	125/125 lm	1972 gr.

## Dimensions

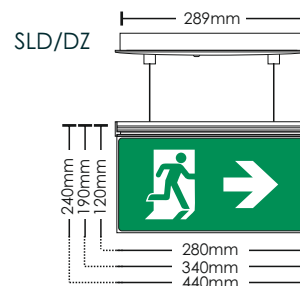
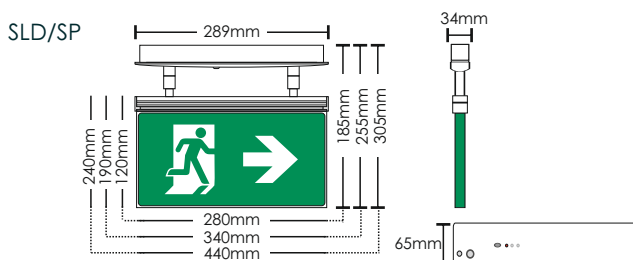

# WIRELESS SPOT LIGHT

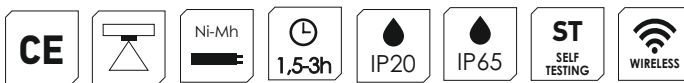
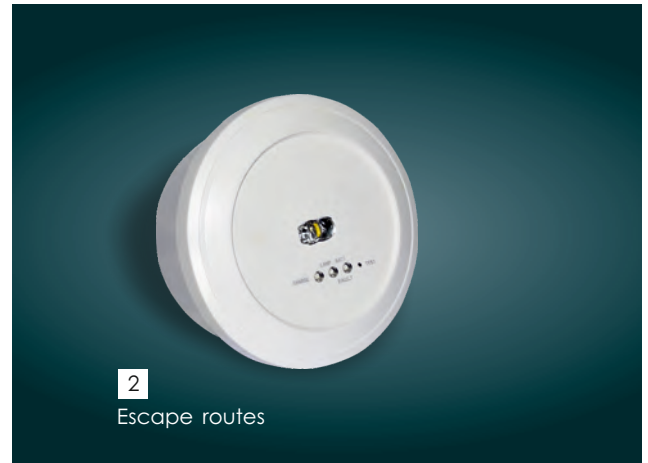

CODE	TYPE	IMAGE	ST	M	NM	Water	Battery	Time	Power	INSTALLATION	Mains/Emergency	kg
923290011	GR-290/M/WL	2	✓	—	✓	IP20	4,8V/4Ah Ni-Mh	1,5h	4,3W/4,7VA	Escape routes	300 lm	439 gr.
923290012	GR-290/WP/M/WL	2	✓	—	✓	IP20	4,8V/4Ah Ni-Mh	1,5h	4,3W/4,7VA	Escape routes	300 lm	439 gr.
923291011	GR-291/M/WL	1	✓	—	✓	IP20	4,8V/4Ah Ni-Mh	1,5h	4,3W/4,7VA	Open areas	300 lm	439 gr.
923291012	GR-291/WP/M/WL	1	✓	—	✓	IP20	4,8V/4Ah Ni-Mh	1,5h	4,3W/4,7VA	Open areas	300 lm	439 gr.
923292010	GR-292/M/WL	2	✓	—	✓	IP20	4,8V/4Ah Ni-Mh	3h	4,3W/4,7VA	Escape routes	150 lm	439 gr.
923292009	GR-292/M/HL/WL	2	✓	—	✓	IP20	4,8V/4Ah Ni-Mh	3h	4,9W/5,2VA	Escape routes	330 lm	925 gr.
923292011	GR-292/WP/M/WL	2	✓	—	✓	IP65	4,8V/4Ah Ni-Mh	3h	4,3W/4,7VA	Escape routes	150 lm	439 gr.
923293010	GR-293/M/WL	1	✓	—	✓	IP65	4,8V/4Ah Ni-Mh	3h	4,3W/4,7VA	Open areas	150 lm	439 gr.
923293009	GR-293/M/HL/WL	1	✓	—	✓	IP65	4,8V/4Ah Ni-Mh	3h	4,9W/5,2VA	Open areas	330 lm	925 gr.
923293011	GR-293/WP/M/WL	1	✓	—	✓	IP65	4,8V/4Ah Ni-Mh	3h	4,3W/4,7VA	Open areas	150 lm	439 gr.

## Dimensions

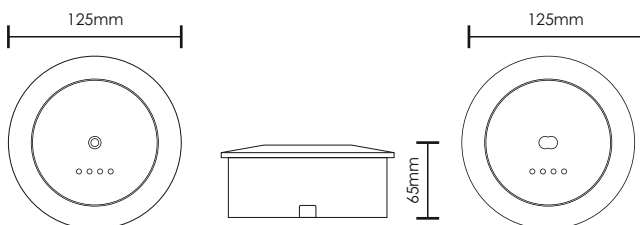

## Photometric

GR-291 & GR-293

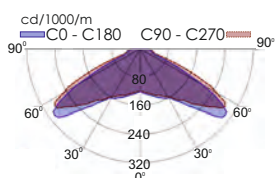

GR-290 & GR-292

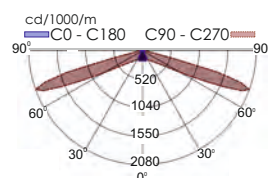

# WIRELESS TETRAGONO LIGHT



CODE	TYPE	ST	M	NM	Waterproof	Battery	Runtime	Power	INSTALLATION	Mains/Emergency	Weight
923490004	GR-490/WP/WL	✓	—	✓	IP65	4,8V/1,2Ah Ni-Mh	1,5 h	3,9W/4,4VA	Escape routes	280lm	854 gr.
923491004	GR-491/WP/WL	✓	—	✓	IP65	4,8V/1,2Ah Ni-Mh	1,5 h	3,9W/4,4VA	Open areas	280lm	854 gr.
923492004	GR-492/WP/WL	✓	—	✓	IP65	4,8V/1,2Ah Ni-Mh	3 h	3,9W/4,4VA	Escape routes	140lm	854 gr.
923493004	GR-493/WP/WL	✓	—	✓	IP65	4,8V/1,2Ah Ni-Mh	3 h	3,9W/4,4VA	Open areas	140lm	854 gr.
923490005	GR-490/WL	✓	—	✓	IP42	4,8V/1,2Ah Ni-Mh	1,5 h	3,9W/4,4VA	Escape routes	280lm	856 gr.
923491005	GR-491/WL	✓	—	✓	IP42	4,8V/1,2Ah Ni-Mh	1,5 h	3,9W/4,4VA	Open areas	280lm	856 gr.
923492005	GR-492/WL	✓	—	✓	IP42	4,8V/1,2Ah Ni-Mh	3 h	3,9W/4,4VA	Escape routes	140lm	856 gr.
923493005	GR-493/WL	✓	—	✓	IP42	4,8V/1,2Ah Ni-Mh	3 h	3,9W/4,4VA	Open areas	140lm	856 gr.

## Dimensions

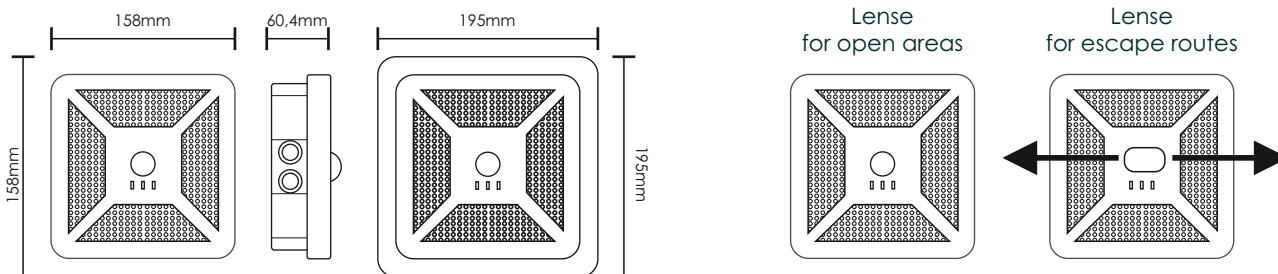

## Photometric

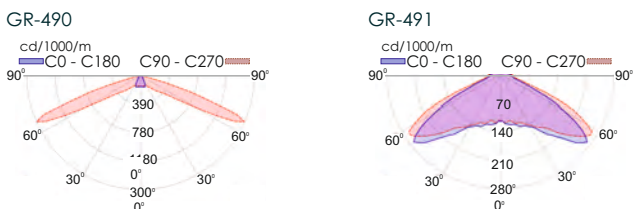

► For accessories & mounting methods go to page 76. For spacing methods go to pages 178-179



# WIRELESS POWER LIGHT



CODE	TYPE	ST	M	NM	Water	Battery	Time	Power	Light source	Light output	kg
923037016	GRL-37/90/WL	✓	—	✓	IP42	12V/7Ah Pb	1,5 h	16VA	2x6P Leds	3200 lm	4360 gr.
923037017	GRL-37/180/WL	✓	—	✓	IP42	2x12V/7Ah Pb	3 h	16VA	2x6P Leds	3200 lm	6560 gr.
923029014	GRL-29/WL	✓	—	✓	IP42	12V/7Ah Pb	3 h	12,6W / 13,1VA	2x84 Leds	1760 lm	3684 gr.
923037018	GRL-37/90/WP/WL	✓	—	✓	IP65	12V/7Ah Pb	1,5 h	16VA	2x6P Leds	3200 lm	4616 gr.
923037019	GRL-37/180/WP/WL	✓	—	✓	IP65	2x12V/7Ah Pb	3 h	16VA	2x6P Leds	3200 lm	6677 gr.
923029015	GRL-29/WP/WL	✓	—	✓	IP65	12V/7Ah Pb	3 h	12,6W / 13,1VA	2x84 Leds	1760 lm	3915 gr.

## Dimensions

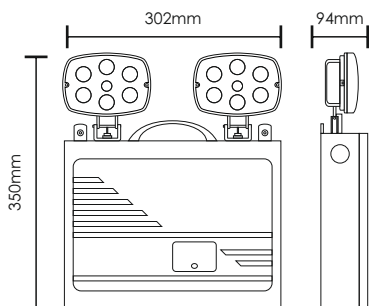



# CENTRAL BATTERY SYSTEMS (CBS)

The CBS family consists of 12 models of central battery systems for emergency illumination.

They are produced in accordance with the current European norms EN50171 and EN50172. Depending on the model they contain 4–16 illumination circuits that can be individually programmed to operate as maintained or non-maintained.

In the maintained illumination circuits a 24VDC voltage is provided from a built-in DC power supply when there is power supply to the facility. In case of an interruption of the mains power supply, the illumination circuits are provided with 24VDC power from the interior of the panel is divided into 2 compartments, the electronics compartment and the battery compartment. A sensor monitors the battery temperature continuously

**Better Energy efficiency** compared to self contained luminaries.

**Low maintenance cost.** The batteries in a CBS system are located in the main panel compared to self contained luminaries that have their batteries built in. This saves a lot of time and money during maintenance, inspection or when batteries need to be changed.

**More effective inspection.** With CBS panels you have the ability to inspect the function of all luminaries from the main panel. If a luminary has a fault then there is an update in the main panel during a programmed test.

**The cost of the CBS luminaries** is comparable to self contained luminaries. With CBS systems you have a long-term cost due to all saving because of all the previous reasons regarding the self contained luminaries.





# CONVENTIONAL BATTERY SYSTEM CBS 24V DC



1

- Output: 24V DC in main & battery
- 300 - 600W panels
- 4 - 16 zones
- Capability for connecting several panels on an ethernet network
- The programming, control and testing of the system can be done using a web browser (Internet Explorer, Mozilla Firefox, Chrome)
- Independent program for each zone for maintained or non-maintained operation.



KM645103  
BS EN 50171

\*They have BSI certification

## Dimensions

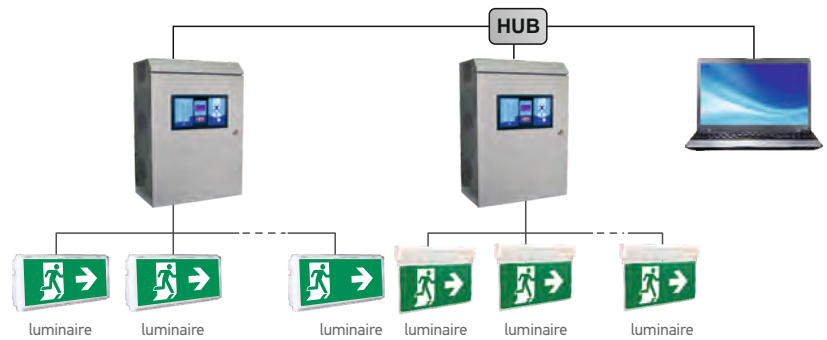
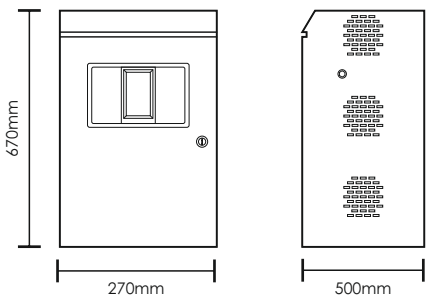

### CENTRAL UNIT PANELS

CODE	TYPE	IMAGE	DESCRIPTION	kg
923850000	GR-8500/300/4	1	300 Watt panel with 4 lighting circuits. Requires 2 batteries 12V/33Ah (A-1200)	19400 gr.
923850001	GR-8500/300/8*	1	300 Watt panel with 8 lighting circuits. Requires 2 batteries 12V/33Ah (A-1200)	19700 gr.
923850002	GR-8500/300/12	1	300 Watt panel with 12 lighting circuits. Requires 2 batteries 12V/33Ah (A-1200)	20000 gr.
923850003	GR-8500/300/16	1	300 Watt panel with 16 lighting circuits. Requires 2 batteries 12V/33Ah (A-1200)	20300 gr.

### 600W / 24V DC PANELS

CODE	TYPE	IMAGE	DESCRIPTION	kg
923850004	GR-8500/600/8	1	600 Watt panel with 8 lighting circuits. Requires 2 batteries 12V/55Ah (A-1202)	20900 gr.
923850005	GR-8500/600/16*	1	600 Watt panel with 16 lighting circuits. Requires 2 batteries 12V/55Ah (A-1202)	21500 gr.

### ACCESSORIES ON DEMAND

CODE	TYPE	IMAGE	DESCRIPTION	kg
923851000	GR-8510	3	4 zone lighting circuit extension card 24V / 300 Watt	293 gr.
923853000	GR-8530	4	Network card through ETHERNET	32 gr.
923821000	GR-8210/MONIT	5	Monitoring device for CBS systems	300 gr.
603101233	A-1200	-	Lead battery 12V/33Ah for 300W Panel	9200 gr.
603101255	A-1202	-	Lead battery 12V/55Ah for 600W Panel	15300 gr.

### PERIPHERALS UPON DEMAND

CODE	TYPE	IMAGE	DESCRIPTION	kg
808385002	GR-8500/PS	6	Spare power supply for maintained operation (GR-8500, GR-8600)	
808385003	GR-8500/PSC	7	Spare power supply for charging (GR-8500, GR-8600, GR-9500)	

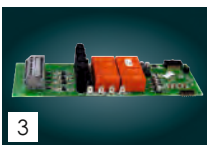

GR-8510



GR-8530



GR-8210/MONIT



GR-8500/PS

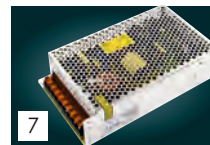

GR-8500/PSC

# CBS 24V DC OLYMPUS LED



Mains 24V

CODE	TYPE	IMAGE	Mains 24V	IP	W	lm	kg
923102408	OLY-1024/CBS/24VDC/WP	2	✓	IP65	2.8W	460lm	675 gr.
923100408	OLY-1004/CBS/24VDC/WP	1	✓	IP65	2.1W	290lm	680 gr.
923102409	OLY-1024/CBS/24VDC	2	✓	IP42	2.8W	460lm	675 gr.
923100409	OLY-1004/CBS/24VDC	1	✓	IP42	2.1W	290lm	680 gr.

## Dimensions

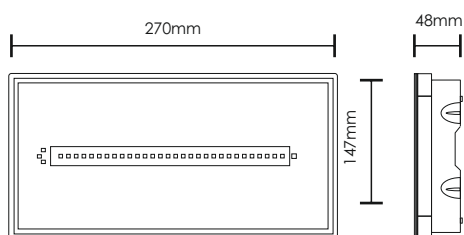

## Photometric

### OLY-1004

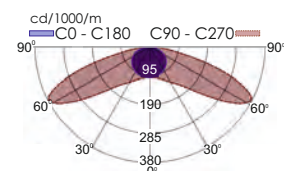
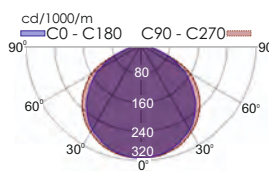

### OLY-1024

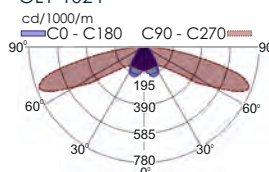

# CBS 24V DC EASY LIGHT



\*They have BSI certification

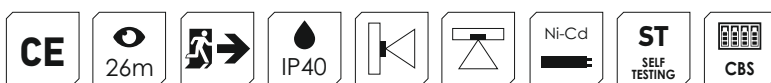

CODE	TYPE	Mains 24V	Water	Light	Mains/Emergency	kg
923325008	GR-325/6P/24V DC/A	✓	IP40	5,7W	580 lm	684 gr.
923324018	GR-324/15L/24V DC/A*	✓	IP40	1W	125 lm	684 gr.
923324019	GR-324/30L/24V DC/A*	✓	IP40	2W	255 lm	684 gr.

## Dimensions

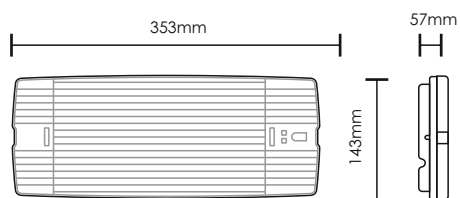

## Photometric

GR-325/6P/24V DC/A, GR-324/15L/24V DC/A, GR-324/30L/24V DC/A

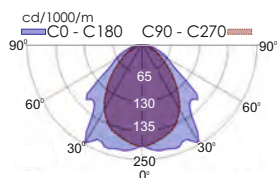

# CBS 24V DC EASY LIGHT



\*They have BSI certification



CODE	TYPE	Mains 24V	Waterproof	Power	Mains/Emergency	Weight
923132404	GR-1324/15L/24V DC	✓	IP40	1W	125 lm	687 gr.
923132405	GR-1324/30L/24V DC	✓	IP40	2W	250 lm	687 gr.

## Dimensions

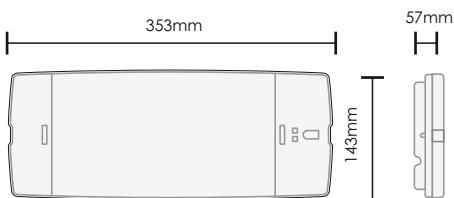

## Photometric

GR-1324/15L/24V DC, GR-1324/30L/24V DC

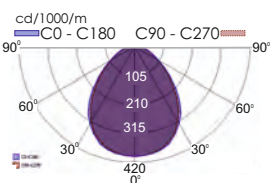

► For accessories & mounting methods go to pages 20-21. For spacing tables go to pages 163-165

# CBS 24V DC WEATHER LIGHT



CODE	TYPE	IMAGE				
923926014	GR-926/15L/24V DC	1	IP65	1,2W	125 lm	835 gr.
923926015	GR-926/30L/24V DC	1	IP65	2,1W	250 lm	835 gr.
923192604	GR-1926/15L/24V DC*	2	IP65	1W	125 lm	620 gr.
923192605	GR-1926/30L/24V DC*	2	IP65	2W	255 lm	620 gr.

## Dimensions

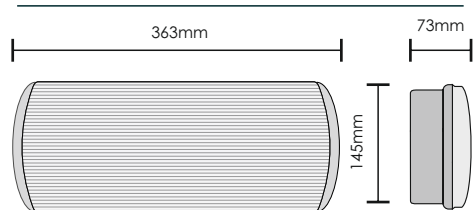

## Dimensions

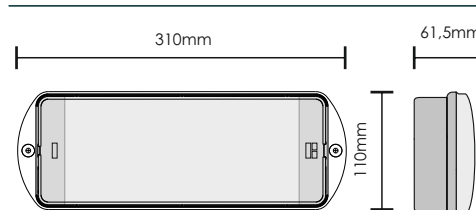

## Photometric

### GR-926/xx

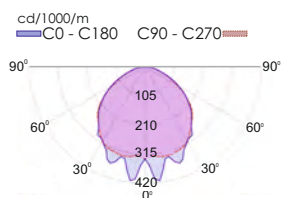

## Photometric

### GR-1926/xx

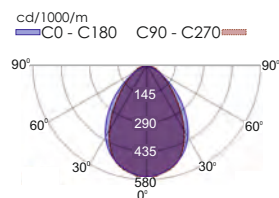

# CBS 24V DC SPOT LIGHT

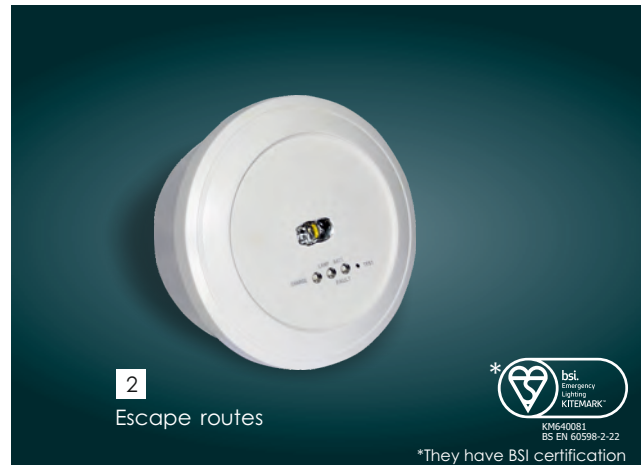
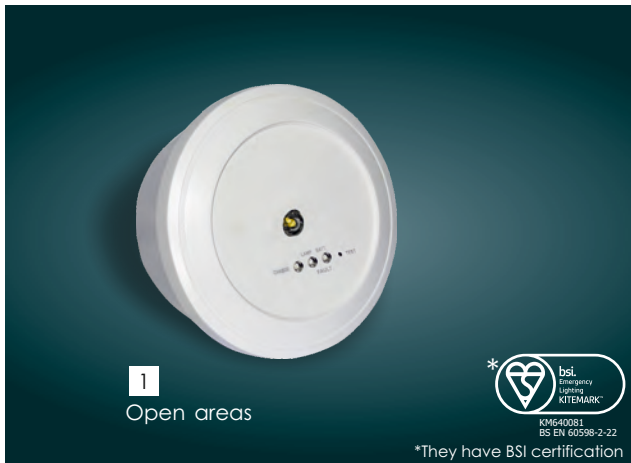

\*They have BSI certification

CODE	TYPE	IMAGE				
923280003	GR-280/24V DC*	2	IP40	2,9W	270 lm	316 gr.
923281003	GR-281/24V DC*	1	IP40	2,9W	270 lm	316 gr.

## Dimensions

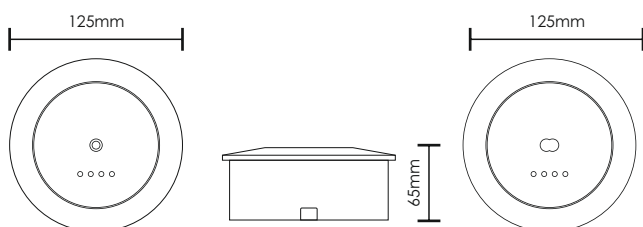

## Photometric

GR-281

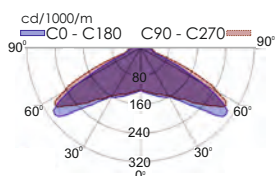

## Photometric

GR-280

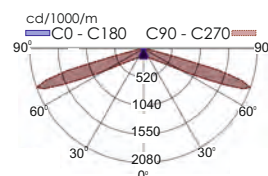

# CBS 24V DC ECO LIGHT



CODE	TYPE	IP	Power	Beam Distance	Weight
922502867	ZLD-28/CBS/24V DC/EM*	IP40	1,4W	150 lm	880 gr.
922503471	ZLD-34/CBS/24V DC/EM*	IP40	1,6W	175 lm	1251 gr.
922504462	ZLD-44/CBS/24V DC/EM	IP40	1,85W	200 lm	1786 gr.

## Dimensions

### ZLD-xx

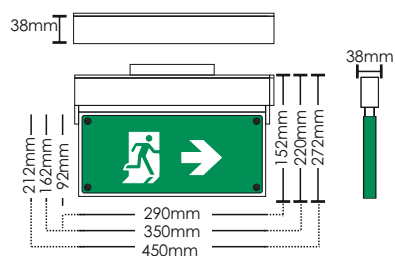

# CBS 24V DC LOUNGE LIGHT



CODE	TYPE	IP	Power	Beam Distance	Mains/Emergency	Weight
922028021	SLD-28/CBS/SP/24V DC	IP30	1,2W	120m		770 gr.
922034020	SLD-34/CBS/SP/24V DC	IP30	1,5W	150m		1238 gr.
922044013	SLD-44/CBS/SP/24V DC	IP30	1,5W	150m		1808 gr.
922028022	SLD-28/CBS/DZ/24V DC	IP30	1,2W	120m		770 gr.
922034021	SLD-34/CBS/DZ/24V DC	IP30	1,5W	150m		1238 gr.
922044014	SLD-44/CBS/DZ/24V DC	IP30	1,5W	150m		1808 gr.

## Dimensions

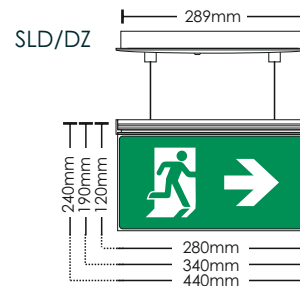
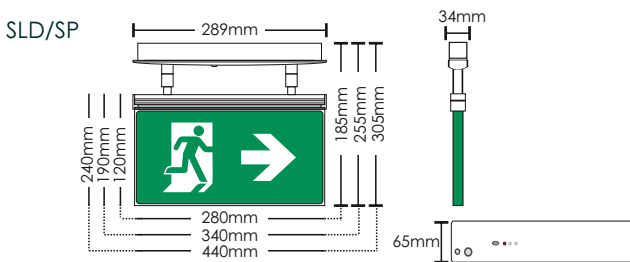



# 24V DC ADDRESSABLE CENTRAL BATTERY SYSTEM (CBS)



1

- Output: 24V DC in main & battery
- 300 - 600W panels
- 4 - 8 zones
- Capability for connecting several panels on an ethernet network
- The programming, control and testing of the system can be done using a web browser (Internet Explorer, Mozilla Firefox, Chrome)
- Independent program for each zone for maintained or non-maintained operation.



KM645103  
BS EN 50171

\*They have BSI certification

## Dimensions

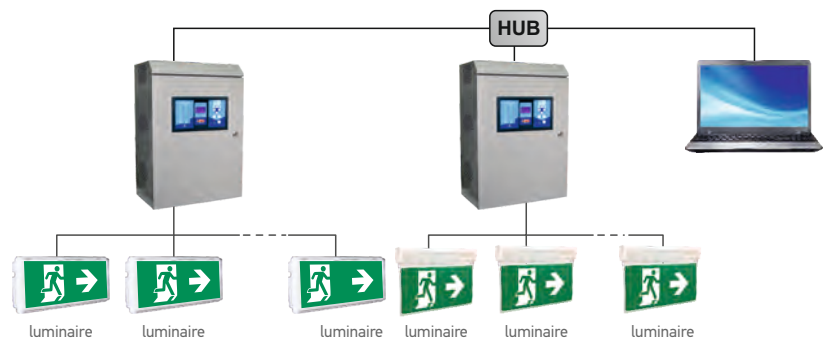
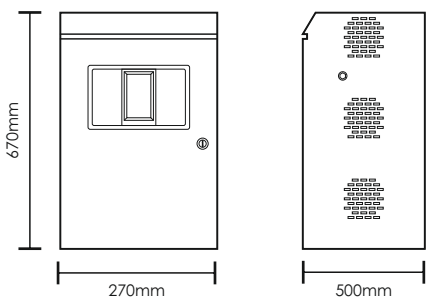

### CENTRAL ADDRESSABLE PANEL 300W / 24V DC PANELS

CODE	TYPE	IMAGE	DESCRIPTION	kg
923860004	GR-8600/300/4*	1	300 Watt panel with 4 lighting circuits. Requires 2 bateries 12V/33Ah (A-1200)	19300 gr.
923860005	GR-8600/300/8*	1	300 Watt panel with 8 lighting circuits. Requires 2 bateries 12V/33Ah (A-1200)	19600 gr.

### 600W / 24V DC PANELS

CODE	TYPE	IMAGE	DESCRIPTION	kg
923860006	GR-8600/600/8*	1	600 Watt panel with 8 lighting circuits. Requires 2 bateries 12V/55Ah (A-1202)	20900 gr.

### ACCESSORIES ON DEMAND

CODE	TYPE	IMAGE	DESCRIPTION	kg
923861000	GR-8610	3	4 zone lighting circuit extension card for addressable luminaires CBS 24V / 300 Watt	347 gr.
923853000	GR-8530	4	Network card through ETHERNET	32 gr.
923821000	GR-8210/MONIT	5	Monitoring device for CBS systems	300 gr.
603101233	A-1200	-	Lead battery 12V/33Ah for 300W Panel	9200 gr.
603101255	A-1202	-	Lead battery 12V/55Ah for 600W Panel	15300 gr.

### PERIPHERALS UPON DEMAND

CODE	TYPE	IMAGE	DESCRIPTION	kg
808385002	GR-8500/PS	6	Spare power supply for maintained operation (GR-8500, GR-8600)	
808385003	GR-8500/PSC	7	Spare power supply for charging (GR-8500, GR-8600, GR-9500)	

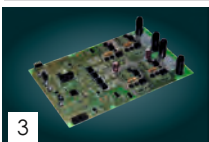

3  
GR-8610



4  
GR-8530



5  
GR-8210/MONIT



6  
GR-8500/PS

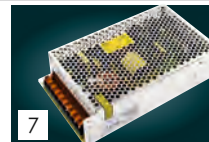

7  
GR-8500/PSC

# ADDRESSABLE 24V DC WEATHER LIGHT



CODE	TYPE				
923192608	GR-1926/15L/24V/ADR*	IP65	1,5W	125 lm	642 gr.
923192609	GR-1926/30L/24V/ADR*	IP65	2,3W	255 lm	642 gr.

## Dimensions

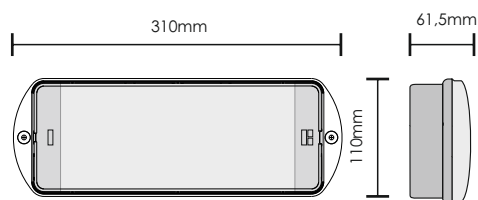

## Photometric

GR-1926/15L/24V/ADR, GR-1926/30L/24V/ADR

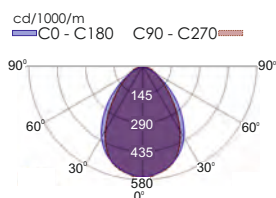

# ADDRESSABLE 24V DC EASY LIGHT



\*They have BSI certification



CODE	TYPE				
923324021	GR-324/15L/24V/ADR/A*	IP40	1,5W	125lm	710 gr.
923324022	GR-324/30L/24V/ADR/A*	IP40	2,3W	255lm	710 gr.

## Dimensions

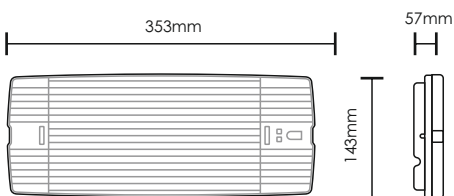

## Photometric

GR-324/15L/24V/ADR/A, GR-324/30L/24V/ADR/A

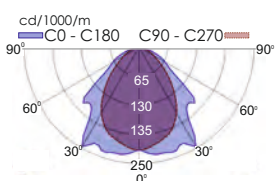

# ADDRESSABLE 24V DC EASY LIGHT



\*They have BSI certification



CODE	TYPE				
923132501	GR-1325/15L/24V/ADR*	IP40	1,5W	125 lm	710 gr.
923132500	GR-1325/30L/24V/ADR*	IP40	2,3W	255 lm	710 gr.

## Dimensions

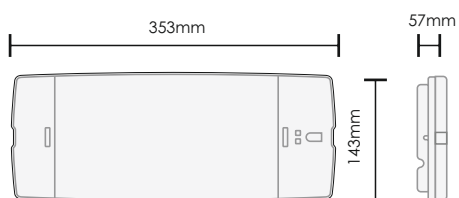

## Photometric

GR-1325/15L/24V/ADR, GR-1325/30L/24V/ADR

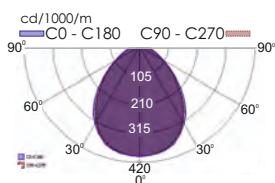

► For accessories & mounting methods go to pages 18-21. For spacing tables go to pages 164-165

# ADDRESSABLE 24V DC LINEAR LIGHT

# ADDRESSABLE 24V DC ECO LIGHT



## KLIN-20



## KLD



CODE	TYPE	IP54	1,2W	Mains/Emergency	kg
922502062	KLIN-20/CBS/24V/ADR	IP54	1,2W	112 lm	914 gr.
922502202	KLD-22/CBS/24V/ADR	IP54	1,2W	112 lm	1105 gr.
922503052	KLD-30/CBS/24V/ADR	IP54	1,2W	112 lm	-

## Dimensions

### KLIN-20



### KLD-30

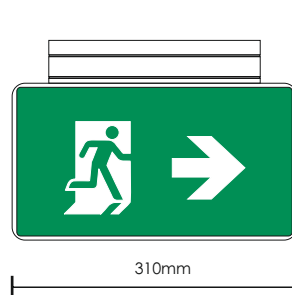

### KLD-22

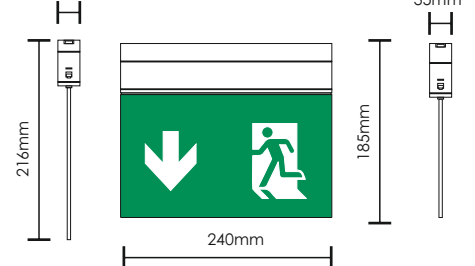

# ADDRESSABLE 24V DC ECO LIGHT



**ZLD**

ZLD-28   ZLD-34   ZLD-44

CE   16m   30m   38m     IP40   IK07         ADR ADDRESSABLE   CBS

**KLR**

CE   20m     IP54           ADR ADDRESSABLE   CBS

CODE	TYPE				
922502869	ZLD-28/24V/ADR/EM*	IP40	1,6W	150 lm	887 gr.
922503473	ZLD-34/24V/ADR/EM*	IP40	1,8W	175 lm	1266 gr.
922502052	KLR-20/CBS/24V/ADR	IP54	1,2W	112 lm	680 gr.

## Dimensions

### ZLD-xx

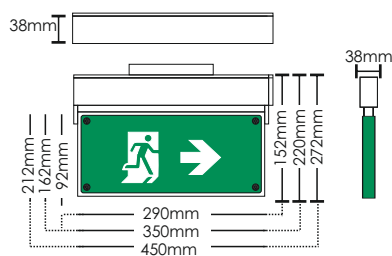

### KLR-20

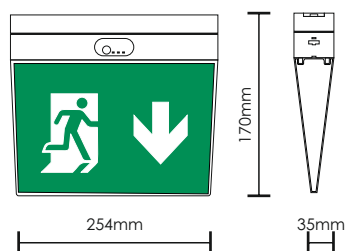

# ADDRESSABLE 24V DC BAU LIGHT

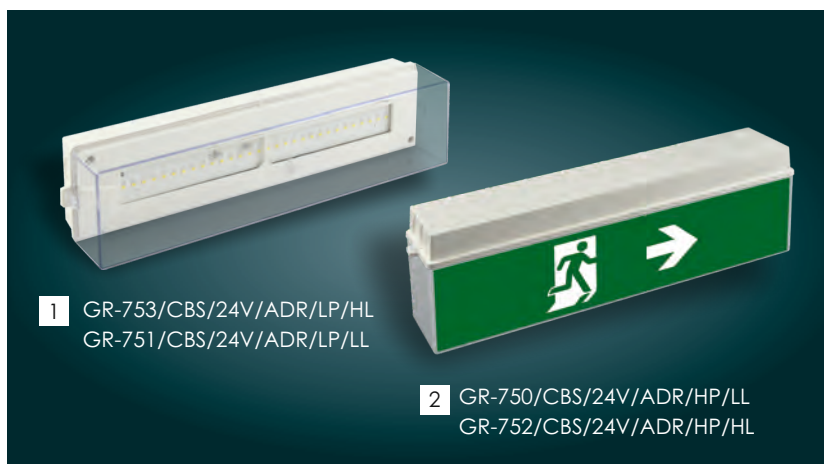

CODE	TYPE				
923750003	GR-750/CBS/24V/ADR/HP/LL	IP54	1,5W	200 lm	753 gr.
923751002	GR-751/CBS/24V/ADR/LP/LL	IP54	1,5W	200 lm	705 gr.
923752002	GR-752/CBS/24V/ADR/HP/HL	IP54	2,5W	350 lm	753 gr.
923753002	GR-753/CBS/24V/ADR/LP/HL	IP54	2,5W	350 lm	705 gr.

## Dimensions

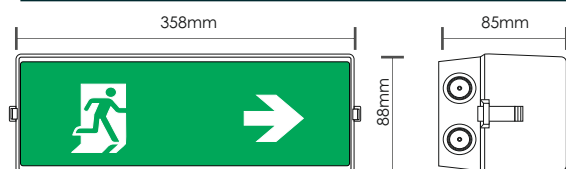

**LP:** Low Profile /deep transparent hood

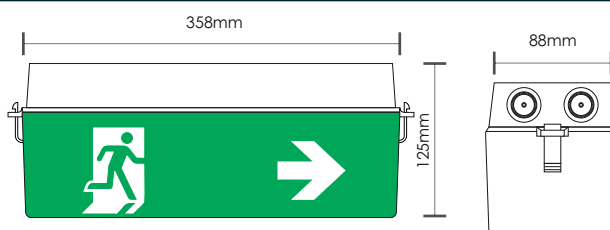

**HP:** High Profile/ High opal hood

# ADDRESSABLE 24V DC LED LIGHT BOX



CODE	TYPE	IP44	2,5W	Mains/ Emergency	kg
923026005	LLB-26/CBS/24V/ADR	IP44	2,5W	300 lm	843 gr.

## Dimensions

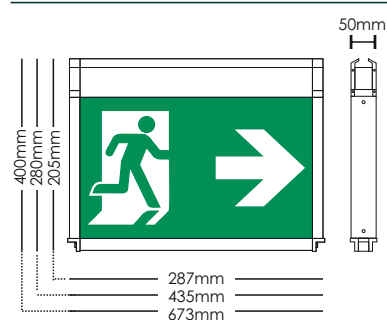



# ADDRESSABLE 24V DC SPOT LIGHT

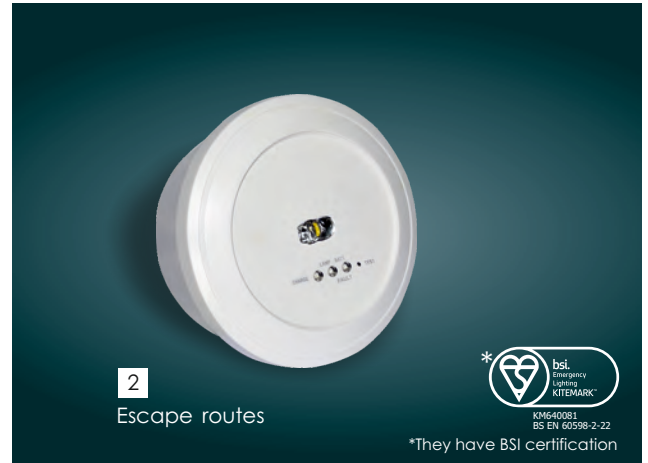
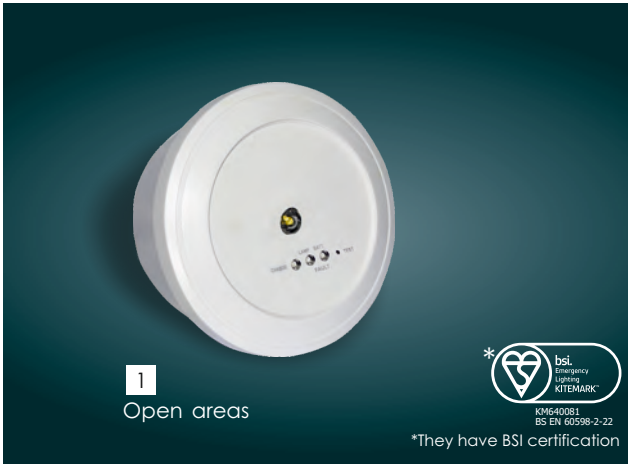

CODE	TYPE	IMAGE	IP	Power	Mains/ Emergency	kg
923281004	GR-281/24V/ADR*	1	IP40	3,2W	270 lm	324 gr.
923280004	GR-280/24V/ADR*	2	IP40	3,2W	270 lm	324gr.

## Dimensions

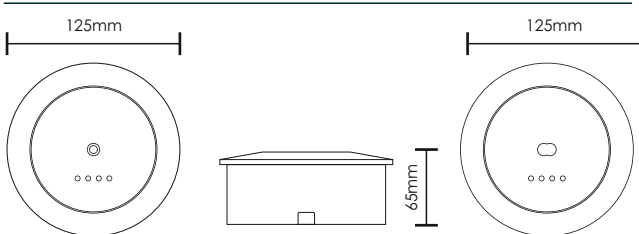

## Photometric

GR-281/24V/ADR

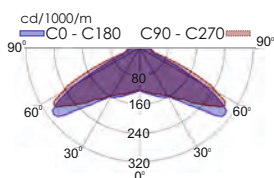

## Photometric

GR-280/24V/ADR

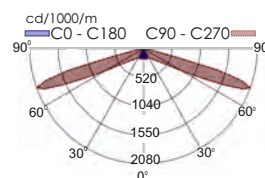



# CONVENTIONAL CBS 230V AC CENTRAL BATTERY SYSTEM



1

- Output: 230V AC in main & battery
- 300VA - 600VA panels
- 4 - 8 zones
- Capability for connecting several panels on an ethernet network
- The programming, control and testing of the system can be done using a web browser (Internet Explorer, Mozilla Firefox, Chrome)
- Independent program for each zone for maintained or non-maintained operation.



KM645103  
BS EN 50171

\*They have BSI certifications

## Dimensions

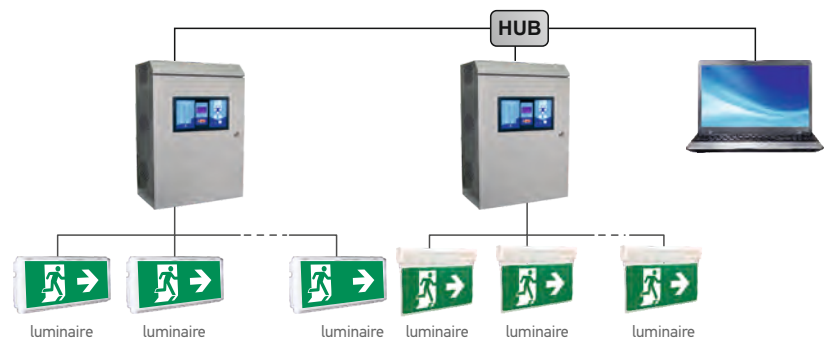
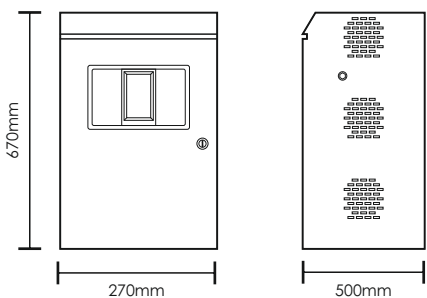

### 300VA/1h or 100VA/3h / 230V AC PANELS

CODE	TYPE	IMAGE	DESCRIPTION	kg
923950002	GR-9500/300/4*	1	4 lighting circuits panel. Requires 2 batteries 12V/33Ah (A-1200)	20500 gr.
923950004	GR-9500/300/8*	1	8 lighting circuits panel. Requires 2 batteries 12V/33Ah (A-1200)	20900 gr.

### 600VA/1h or 200VA/3h / 230V AC PANELS

CODE	TYPE	IMAGE	DESCRIPTION	kg
923950003	GR-9500/600/8*	1	8 lighting circuits panel. Requires 2 batteries 12V/55Ah (A-1202)	22500 gr.

### ACCESSORIES ON DEMAND

CODE	TYPE	IMAGE	DESCRIPTION	kg
923951000	GR-9510	3	4 zone lighting circuit extension card 230V / 300 Watt	293 gr.
923853000	GR-8530	4	Network card through ETHERNET	32 gr.
923821000	GR-8210/MONIT	5	Monitoring device for CBS systems	300 gr.
603101233	A-1200	-	Lead battery 12V/33Ah for 300W Panel	9200 gr.
603101255	A-1202	-	Lead battery 12V/55Ah for 600W Panel	15300 gr.

### PERIPHERALS UPON DEMAND

CODE	TYPE	IMAGE	DESCRIPTION	kg
808385003	GR-8500/PSC	6	Spare power supply for charging (GR-8500, GR-8600, GR-9500)	1131 gr.



3  
GR-8510



4  
GR-8530



5  
GR-8210/MONIT

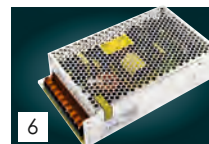

6  
GR-8500/PSC

# CBS 230V AC OLYMPUS LED



CODE	TYPE	IMAGE	IP	Wattage	VA	Beam Spread	Weight
923102406	OLY-1024/CBS/230V/WP	2	IP65	4.8W	5.1VA	580lm	700 gr.
923100406	OLY-1004/CBS/230V/WP	1	IP65	3.4W	3.7VA	380lm	705 gr.
923102407	OLY-1024/CBS/230V	2	IP42	4.8W	5.1VA	580lm	700 gr.
923100407	OLY-1004/CBS/230V	1	IP42	3.4W	3.7VA	380lm	705 gr.

## Dimensions

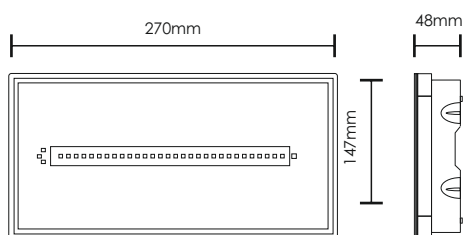

## Photometric

OLY-1004

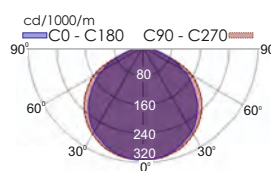

OLY-1024

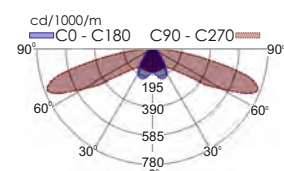

# CBS 230V AC EASY LIGHT



\*They have BSI certification



CODE	TYPE	IP	Wattage	VA	lm	kg
923324013	GR-324/4P/A	IP40	5.3W	5.4VA	460 lm	725.5 gr.
923325006	GR-325/6P/A	IP40	6.7W	7VA	580 lm	725.5 gr.
923324014	GR-324/15L/A*	IP40	1.5W	1.9VA	125 lm	731 gr.
923324015	GR-324/30L/A*	IP40	2.8W	3.1VA	250 lm	731 gr.

## Dimensions

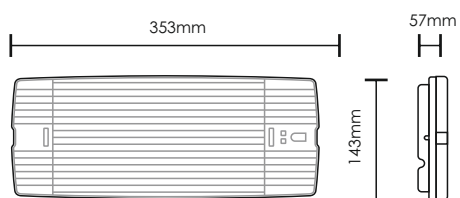

## Photometric

GR-324/4P/A, GR-325/6P/A, GR-324/15L/A\*, GR-324/30L/A\*

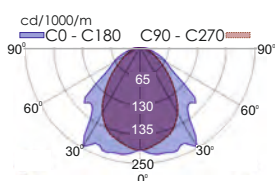

# CBS 230V AC EASY LIGHT



\*They have BSI certification



CODE	TYPE	IP40	1,5W/1,9VA	Mains/ Emergency	kg
923132400	GR-1324/15L*	IP40	1,5W/1,9VA	125 lm	713 gr.
923132401	GR-1324/30L*	IP40	2,8W/3,1VA	250 lm	713 gr.

## Dimensions

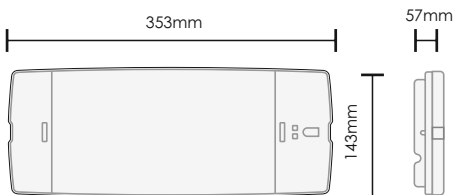

## Photometric

GR-1324/15L, GR-1324/30L

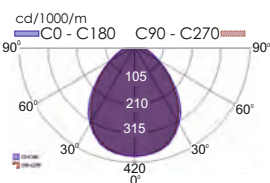

► For accessories & mounting methods go to pages 20-21. For spacing tables go to pages 164-165

# CBS 230V AC WEATHER LIGHT



CODE	TYPE	IMAGE	IP	Wattage	VA	lm	kg
923926005	GR-926/4P	1	IP65	5,8W	6,9VA	460 lm	834 gr.
923926006	GR-926/6P	1	IP65	6,5W	6,9VA	580 lm	834 gr.
923926007	GR-926/15L	1	IP65	1,75W	2VA	125 lm	863 gr.
923926008	GR-926/30L	1	IP65	2,9W	3,2VA	250 lm	863 gr.
923192600	GR-1926/15L*	2	IP65	1,5W	1,9VA	125 lm	653 gr.
923192601	GR-1926/30L*	2	IP65	2,8W	3,1VA	250 lm	653 gr.
923192610	GR-1926/4P	2	IP65	5,3W	5,4VA	460 lm	659 gr.
923192611	GR-1926/6P	2	IP65	6,3W	7VA	580 lm	659 gr.

## Dimensions

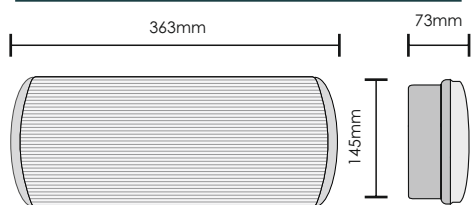

## Dimensions

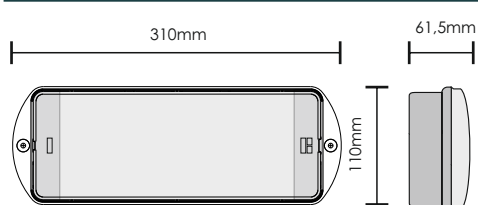

## Photometric

### GR-926/xx

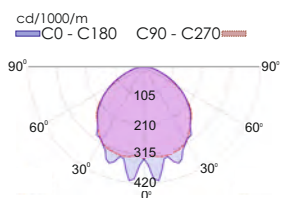

## Photometric

### GR-1926/xx

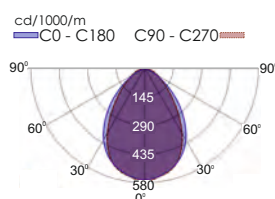

# CBS 230V AC SLIM LEDS LIGHT

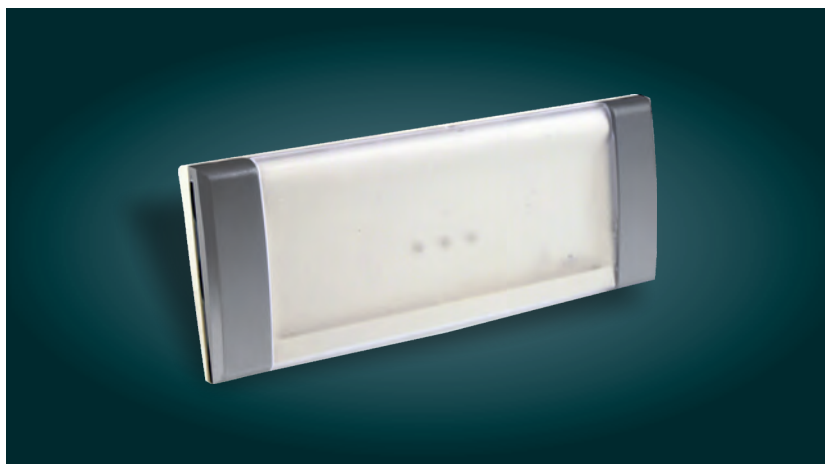

CODE	TYPE	IP40	1,55W/1,78VA	Mains/ Emergency	kg
923200004	GR-2000/CBS				350 gr.

## Dimensions

GR-2000

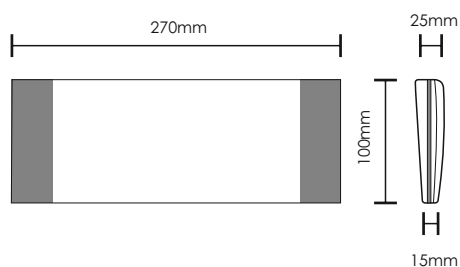

## Photometric

GR-2000

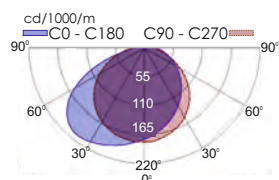

► For accessories & mounting methods go to pages 12-13.



# CBS 230V AC ECO LIGHT



**ZLD-xx**

ZLD-28 ZLD-34 ZLD-44

CE 16m 30m 38m

IP40 IK07

CBS

**PLD-28**

CE 26m

IP44 IK09

CBS

CODE	TYPE	IMAGE	IP	Wattage	VA	lm	kg
922502863	ZLD-28/CBS/EM*	1	IP40	1,9W	2,1VA	150 lm	985 gr.
922503468	ZLD-34/CBS/EM*	1	IP40	2,2W	2,42VA	175 lm	1380 gr.
922504459	ZLD-44/CBS/EM	1	IP40	2,6W	2,86VA	200 lm	1910 gr.
922502504	PLD-25/CBS	2	IP44	1,6W	1,8 VA	100 lm	885 gr.

## Dimensions

### ZLD-xx

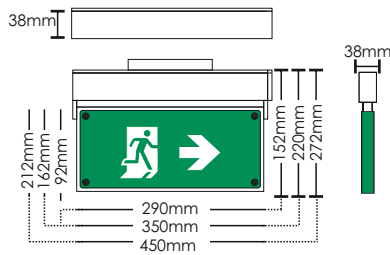

### PLD-25

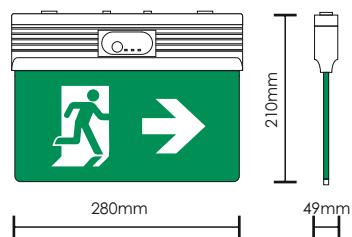

# CBS 230V AC ECO LIGHT



## KLR

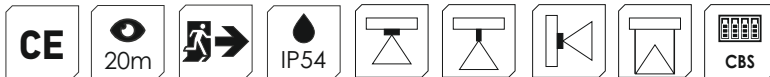

## KLD



CODE	TYPE	IMAGE	IP54	1,3W/1,7VA	Mains/ Emergency	kg
922502053	KLR-20/CBS	1	IP54	1,3W/1,7VA	100 lm	680 gr.
922502203	KLD-22/CBS	2	IP54	1,3W/1,7VA	100 lm	914 gr.
922503053	KLD-30/CBS	3	IP54	1,3W/1,7VA	100 lm	1165 gr.

## Dimensions

KLR-20

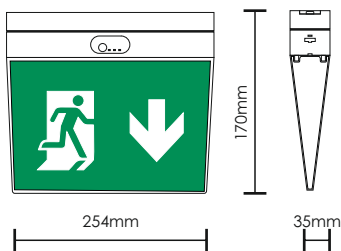

KLD-22

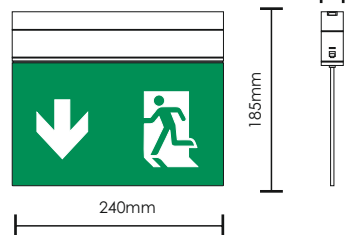

KLD-30

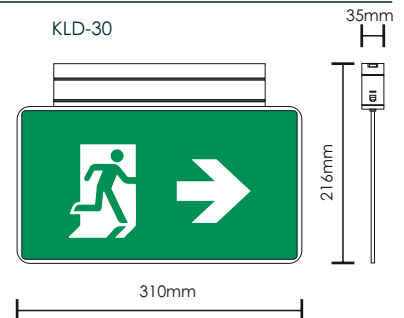

# CBS 230V AC PROJECT LIGHT



	GRL-82x	GRL-83x	GRL-84x					
<b>CE</b>	37m	49m	65m		IP42			
	DLD-28x	DLD-34x	DLD-44x					
<b>CE</b>	16m	30m	38m		IP42			

CODE	TYPE	IMAGE				kg
923860302	GRL-860/EM	1	IP42	5,4W/5,7VA	510 lm	1388 gr.
923870103	GRL-870/EM	1	IP42	6,2W/7,4VA	680 lm	1955 gr.
923880103	GRL-880/EM	1	IP42	8,8W/9,1VA	850 lm	2565 gr.
922202870	DLD-28/CBS/w	2	IP42	1,5W/4,5VA	100 lm	643 gr.
922603401	DLD-34/CBS/w	2	IP42	1,5W/4,5VA	125 lm	1000 gr.
922604410	DLD-44/CBS/w	3	IP42	1,5W/4,5VA	125 lm	1620 gr.

## Dimensions

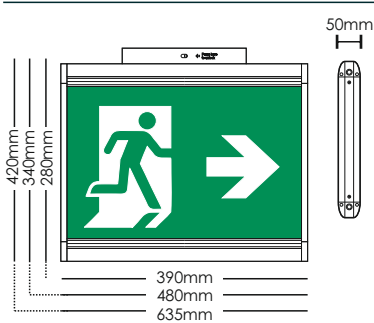

## Dimensions

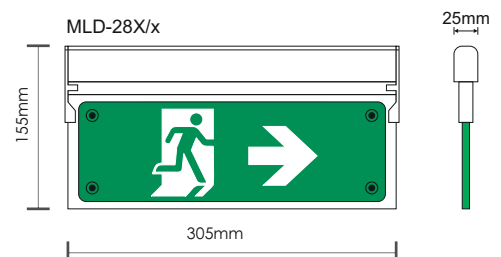
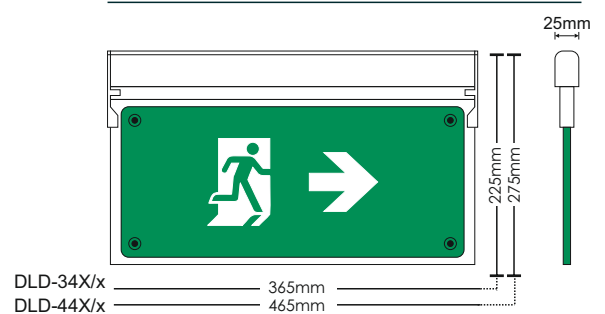

# CBS 230V AC LOUNGE LIGHT



CODE	TYPE	IMAGE	IP	Power	Light Output	Weight
922028009	SLD-28/CBS/SP	1	IP30	1,35W/1,60VA	100 lm	930 gr.
922034010	SLD-34/CBS/SP	1	IP30	1,65W/1,9VA	125 lm	1260 gr.
922044007	SLD-44/CBS/SP	1	IP30	1,65W/1,9VA	125 lm	1970 gr.
922028003	SLD-28/CBS/DZ	2	IP30	1,35W/1,60VA	100 lm	930 gr.
922034004	SLD-34/CBS/DZ	2	IP30	1,65W/1,9VA	125 lm	1260 gr.
922044003	SLD-44/CBS/DZ	2	IP30	1,65W/1,9VA	125 lm	1970 gr.

## Dimensions

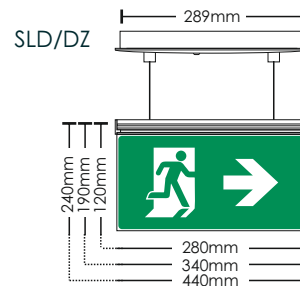
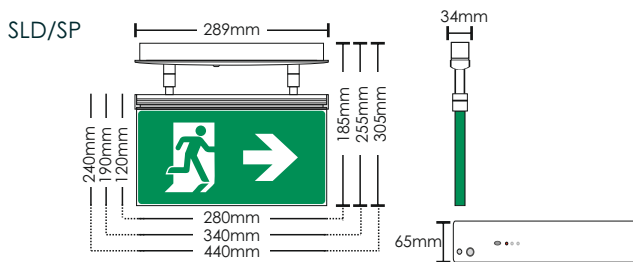

# CBS 230V AC BAU LIGHT

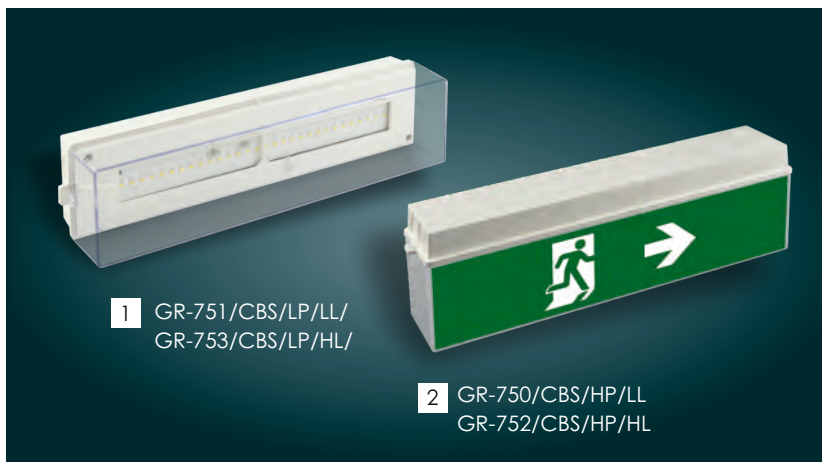

CODE	TYPE	IMAGE				
923750002	GR-750/CBS/HP/LL LOW LUMINOSITY	2	IP54	2W/2,3VA	190 lm	771 gr.
923751001	GR-751/CBS/LP/LL LOW LUMINOSITY	1	IP54	2W/2,3VA	190 lm	722 gr.
923752001	GR-752/CBS/HP/HL HIGH LUMINOSITY	2	IP54	3,3W/3,6VA	350 lm	771 gr.
923753001	GR-753/CBS/LP/HL HIGH LUMINOSITY	1	IP54	3,3W/3,6VA	350 lm	722 gr.

## Dimensions

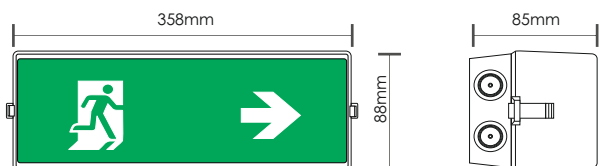

**LP:** Low Profile /deep transparent hood

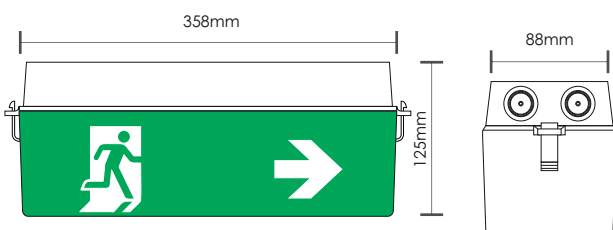

**HP:** High Profile/ High opal hood

# CBS 230V AC LED LIGHT BOX



CODE	TYPE	IP44	Power	Beam Distance	Mains/Emergency	Weight (kg)
923026006	LLB-26/CBS	IP44	2,3W/2,8VA	26m	Mains/Emergency	963 gr.
923040005	LLB-40/CBS	IP44	3,4W/3,8VA	40m	Mains/Emergency	1644 gr.
923064005	LLB-64/CBS	IP44	5,8W/6,2VA	64m	Mains/Emergency	2917 gr.

LLB-XX/○ All the above models can be manufactured as one sided luminaires with aluminum backplate

## Dimensions

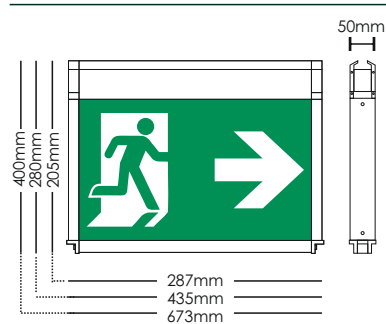

# CBS 230V AC SPOT LIGHT



CODE	TYPE	IMAGE	IP	W	V	VA	INSTALLATION	Mains/ Emergency	kg
923281000	GR-281*	1	IP40	2,6W	3VA		Open areas	270lm	333 gr.
923280000	GR-280*	2	IP40	2,6W	3VA		Escape routes	270lm	333 gr.
923296000	GR-296/30L/CBS/230V	3	IP40	2,9W	3,3VA		-	255lm	340 gr.
923296001	GR-296/60L/CBS/230V	3	IP40	5,2W	5,6VA		-	510lm	340 gr.
923288000	GR-288	4	IP40	2,6W	3VA		Points of interest	270lm	250 gr.

## Dimensions

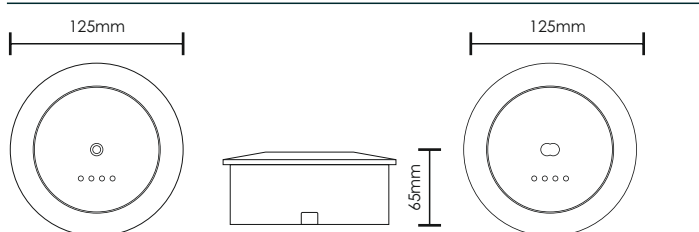

## Photometric

GR-281

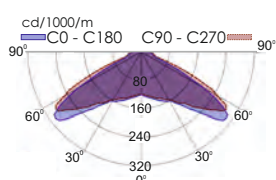

GR-280

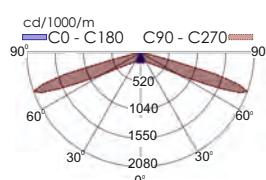

# CBS 230V AC TETRAGONO LIGHT



CODE	TYPE	IP	Wattage	INSTALLATION	Mains/ Emergency	kg
923480000	GR-480/CBS/WP	IP65	3,2W/4VA	Escape routes	270m	627 gr.
923481000	GR-481/CBS/WP	IP65	3,2W/4VA	Open areas	270m	630 gr.
923480001	GR-480/CBS	IP42	3,2W/4VA	Escape routes	270m	627 gr.
923481001	GR-481/CBS	IP42	3,2W/4VA	Open areas	270m	630 gr.

## Dimensions

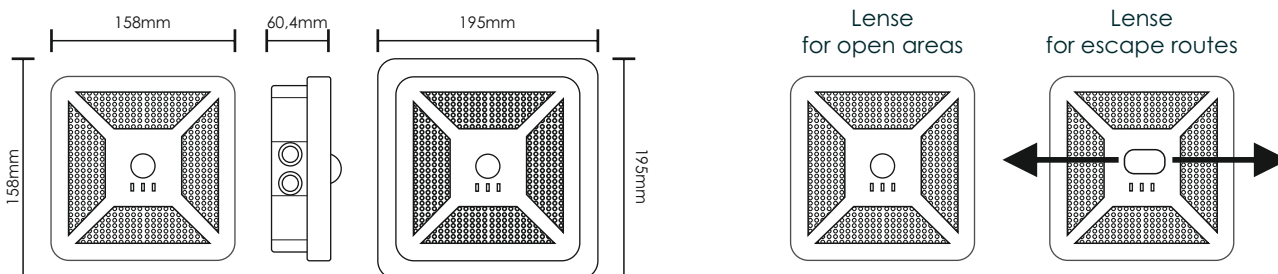

## Photometric

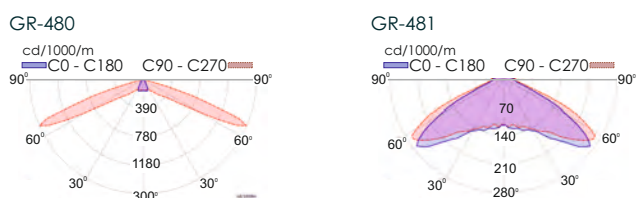

► For accessories & mounting methods go to pages 76. For spacing tables go to pages 178-179



# CBS 230V AC 3D LIGHT

# CBS 230V AC TUNNEL LIGHT



GR-573/L/316Ti/CBS



GR-424/1PL



CODE	TYPE	IMAGE	Water	Lightning	Mains/Emergency	kg
923424003	GR-424/1PL	1	IP50	4.4W/4.6VA	500lm	3170 gr.
923573004	GR-573/L/316Ti/CBS	2	IP66	9.6W/9.9VA	230cd/m2 (sign) / 120cd/m2 (indicatively)	9200 gr.

## Dimensions

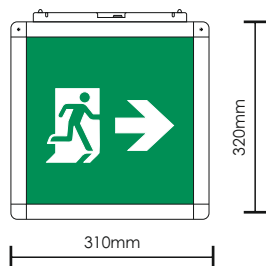

## Dimensions

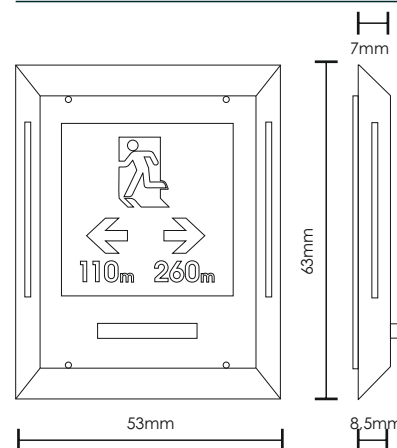

# CBS 230V AC TUNNEL LIGHT



CODE	TYPE	IMAGE	IP65	⚡	Mains/ Emergency	kg
923575100	GR-575/L/WP	1	IP65	2x6,4W/6,8VA	1360 lm (2x680)	10567 gr.
923576100	GR-576/L/15/WP	2	IP65	7,2W/7,6VA	680 lm	-
923576102	GR-576/L/15/WP/O	2	IP65	7,2W/7,6VA	680 lm	-
923576101	GR-576/L/18/WP	2	IP65	8,2W/8,7VA	850 lm	-
923576103	GR-576/L/18/WP/O	2	IP65	8,2W/8,7VA	850 lm	-

**GR-57X/XW/WP/B** All the above models can be manufactured with xenon red beacon on top

## Dimensions

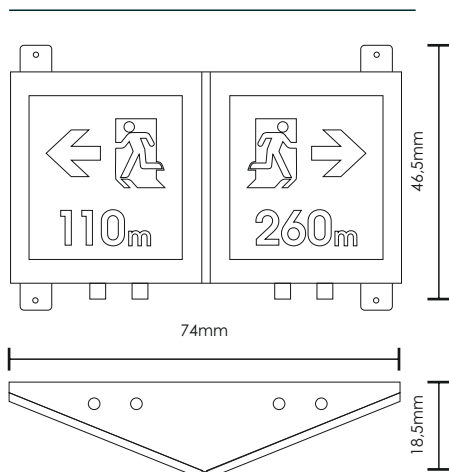

## Dimensions

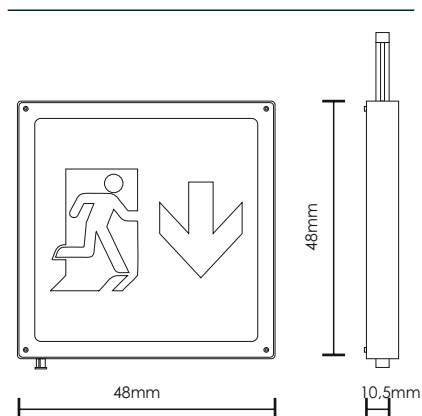





► For accessories & mounting methods go to page 65

# CBS 230V AC GR-200

# CBS 230V AC ANTIEXPLOSIVE LED LIGHT



CODE	TYPE	IMAGE			Diffuser	 Mains/ Emergency	
923200100	GR-200/CBS/WP	1	IP65	16W/16.9VA	-	1850lm	929 gr.
923411100	PSL1100	2	IP66	< 65mA	polycarbonate	1200lm	4.300 gr.
923411200	PSL1200	2	IP66	< 100mA	polycarbonate	2200lm	4.400 gr.
923412200	PSL2200	2	IP66	< 100mA	polycarbonate	2500lm	5.500 gr.
923412400	PSL2400	2	IP66	< 180mA	polycarbonate	4200lm	5.600 gr.
923413400	PSL3400	2	IP66	< 180mA	polycarbonate	4900lm	10.300 gr.

ACCESSORIES  
MARKING  
SIGNS

# ACCESSORIES / REPLACEMENTS

A-1015	927101500	Recess mounting base for Classic Light
A-1018/PL	927101801	Recess mounting base for MLD-28
A-1018/PL/ST	927101802	Recess mounting base for self-testing luminaires ZLD-28
A-1020/PL	927102001	Recess mounting base MLD-34, DLD-34
A-1020/PL/ST	9271 02002	Recess mounting base for self-testing luminaires ZLD-34
A-1900	927190000	Magnetic test card
A-2000/W	927200000	Set left - right decorative covers for GR-2000 (white color)
A-2000/B	927200001	Set left - right decorative covers for GR-2000 (bronze color)
A-2000/BLACK	927200004	Set left - right decorative covers for GR-2000 (black color)
A-3008	927300800	Base for recessed mounting on suspended ceiling (A-3018 mounting springs are included)
A-9100	927910001	Double sided diffuser for Weather Light GR-19xx
A-9100/ST	927910000	Double sided diffuser for self-testing luminaires for Weather Light GR-19xx
A-1017	927101700	Plastic double sided diffuser for Weather Light GR-9xx
A-1130	927311300	Set of accessories (1m) for ceiling mounting (silver)
A-1131	927311310	Set of accessories (0,5m) for ceiling mounting (silver)
A-1132	927311320	Set of accessories (0,25m) for ceiling mounting (silver)
A-1133	927311330	Accessory for vertical wall mounting (silver) (Only for ZLD 28/34 EM)
A-1134	927311340	Accessory for wall mounting (silver)
A-1135	927311350	Accessory for vertical wall mounting (For LLB-26/90/180)
A-1136	927311360	Accessory set for ceiling mounted hanging installations with 0,25m cable (For LLB-26 & LLB-40)
A-2130	927321300	Set of accessories for ceiling mounting (1m) (white)
A-2131	927321310	Set of accessories for ceiling mounting (0,5m) (white)
A-2132	927321320	Set of accessories for ceiling mounting (0,25m) (white)
A-2133	927321330	Accessory set for vertical wall mounting for "KLR", "KLD" & "PLD"(white)
A-2136	927321360	Accessory set for ceiling mounted hanging installations with 2,5m cable
A-2510/PL	927251001	Suspended mounting base for luminaires without Autotest
A-2510/PL/ST/M	927251002	Suspended mounting base for Self-testing luminaires
A-2520/PL	927252001	Suspended ceiling base
A-2520/PL/ST	927252000	Suspended ceiling base for self-testing luminary KLD-xx
A-3018	980330180	Suspended ceiling mounting springs
A-9000	927900001	Ceiling bracket for GR-9xx/xxL
A-FSA	808700069	Mounting base
GR-6079	923607900	Addressable module for LED GR-1107xx and fluorescent lamp converters GR-1004xx
GR-8210/MONIT	923821000	Monitoring device for CBS systems
GR-8500/PS	808385002	Spare power supply for maintained operation (GR-8500, GR-8600)
GR-8500/PSC	808385003	Spare power supply for charging (GR-8500, GR-8600, GR-9500)
GR-8510	923851000	4 zone lighting circuit extension card 24V/300 Watt
GR-8530	923853000	Network card through ETHERNET
GR-8610	923861000	4 zone lighting circuit extension card for addressable luminaires CBS 24V/300 Watt
GR-9510	923951000	4 zone lighting circuit extension card 230V/300 Watt
IRT200A	927200100	Remote control for GR-2000 (15 keys)
NPT34	751500102	Sealing grommet
SP-1100/RLDUB	922110005	Double sided Plexiglass 6mm marking panel for all directions (For Olympus series)
SP-1008/RLDUB	922100800	Double sided Plexiglass 4mm marking panel for all directions (For GR-8 & GR-9 leds)
SP-116/RLDUB	922116006	Double sided Plexiglass 4mm marking panel for all directions (For Easy Light)

# BATTERIES

**Batteries** (1 year Guarantee)

Type	Code	Description
3.6V / 240mAh NiMH	601303220	Battery 3,2V/2Ah LiFePO4
A-918/HT	601303220	Battery 3,2V/2Ah LiFePO4
A-926	601003606	Battery 3,6V/600mAh Ni-Cd
A-931/HT	601233610	Battery 3,6V/1000mAh HT NiCd
A-938/HT	601223610	Battery 3,6V/1Ah Ni-Cd
A-947	601103601	Battery 3,6V/120mAh Ni-Mh
A-965/HT	601103612	Battery 3,6V/1,2Ah Ni-Mh
A-986	603001270	Battery 12V/7Ah
B-1250/HT	808001250	Battery 8V/6Ah Ni-Cd
B-925/HT	601404820	Battery 4,8V/2Ah lithium-titanate-oxide (LTO)
B-936/HT60SC	601134840	Battery 4,8V/4Ah Ni-Mh
B-941/HT	601214830	Battery 4,8V/3Ah Ni-Cd
B-949/HT	601233630	Battery 3,6V/3Ah Ni-Cd
B-954/HT	601134820	Battery 4,8V/2Ah Ni-Mh
B-972/HT	601213615	Battery 3,6V/1,5Ah HT Ni-Cd
B-973/HT	601214815	Battery 4,8V/1,5Ah HT Ni-Cd
B-975/HT	601133640	Battery 4,8V/3Ah Ni-Cd
C-930/HT	601104812	Battery 4,8V/1,2Ah Ni-Mh
GR-71	923071000	Battery Set Ni-Cd 8,4V/1,5Ah
GR-72	923072000	Battery Set Ni-Cd 8,4V/3Ah
GR-81	923081000	Battery Set Ni-Cd 6V/1,5Ah
GR-82	923082015	Battery Set Ni-Cd 6V/3Ah

# MARKING SIGNS



SP-214/S229



SP-214/S228



SP-214/S232



SP-215/S65R  
SP-216/S65R





Please mention the type of the sign with extension of the required marking diagram e.g. SP-214/S229

- For orders with new designs upon customers demand will be extra cost
- They are installed in areas where proper information and guidance of the public is required without safety lighting requirements.
- The symbols below comply with the European Norms.

SAFE CONDITION SIGNS													
FIRE EQUIPMENT SIGNS													
MANDATORY ACTION SIGNS													
PROHIBITION SIGNS													
WARNING SIGNS													

# PHOTO LUMINESCENT MARKING SIGNS FOR SHIPS

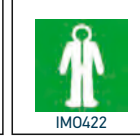
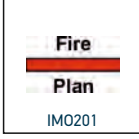
The symbols below comply with the European Norms.

 IMO101	 IMO111	 IMO203	 IMO213	 IMO223	 IMO233	 IMO243	 IMO406	 IMO417
 IMO102	 IMO112	 IMO204	 IMO214	 IMO224	 IMO234	 IMO244	 IMO408	 IMO418
 IMO103	 IMO113	 IMO205	 IMO215	 IMO225	 IMO235	 IMO301	 IMO409	 IMO419
 IMO104	 IMO114	 IMO206	 IMO216	 IMO226	 IMO236	 IMO302	 IMO410	 IMO420
 IMO105	 IMO115	 IMO207	 IMO217	 IMO227	 IMO237	 IMO401	 IMO411	 IMO421
 IMO106	 IMO116	 IMO208	 IMO218	 IMO228	 IMO238	 IMO402	 IMO412	 IMO422
 IMO107	 IMO117	 IMO209	 IMO219	 IMO229	 IMO239	 IMO403	 IMO413	 IMO423
 IMO108	 IMO118	 IMO210	 IMO220	 IMO230	 IMO240	 IMO404	 IMO414	 IMO424
 IMO109	 IMO201	 IMO211	 IMO221	 IMO231	 IMO241	 IMO405	 IMO415	 IMO425
 IMO110	 IMO202	 IMO212	 IMO222	 IMO232	 IMO242	 IMO406	 IMO416	 IMO426
						 IMO427	 IMO428	 IMO429





# SPACING TABLES

## **Escape routes. Spacing table is based on following parameters:**





Maintenance factor:	1.0
Emergency lighting factor:	1.0
Minimum illuminance on center line:	1.0 lx
Minimum illuminance on half of escape route width:	0.5 lx
Diversity on the centre line max	40: 1
Width of the escape route:	2.0 m

## **Anti-panic areas. Spacing table is based on following parameters:**





Maintenance factor:	1.0
Emergency light factor:	1.0
Minimum illuminance in anti-panic area:	0.50 lx
E <sub>max</sub> / E <sub>min</sub>	40: 1
Distance from the wall:	0.50m

### SLIM LIGHT

Escape route, 1Lux floor luminosity





Models	Height (m)				
GR-8/leds	2	2.26	5.51	5.82	2.37
GR-9/leds	2,5	2.43	6.08	6.40	2.54
	3	2.53	6.53	6.84	2.62
	3,5	2.53	6.87	7.18	2.61
	4	2.44	7.09	7.38	2.51
	4,5	2.23	7.17	7.44	2.31
	5	1.82	7.16	7.38	1.92
	5,5	1.08	7.00	7.19	1.15
	6	0.00	6.67	6.88	0.00

Open area, 0.5Lux floor luminosity





Models	Height (m)				
GR-8/leds	2	2.73	6.55	6.93	2.87
GR-9/leds	2,5	3.02	7.31	7.73	3.17
	3	3.24	7.98	8.40	3.39
	3,5	3.41	8.54	8.98	3.55
	4	3.52	9.01	9.44	3.65
	4,5	3.57	9.40	9.83	3.68
	5	3.55	9.71	10.13	3.66
	6	3.31	10.07	10.45	3.38
	7	2.63	10.11	10.41	2.66
	8	0.56	9.74	10.00	0.56
	9	0.00	8.02	8.25	0.00

### CLASSIC LIGHT





Escape route, 1Lux floor luminosity

Models	Height (m)				
GR-108/12L/90	2	2.27	5.80	4.82	2.34
GR-109/12L/180	2,5	2.32	6.21	5.00	2.39
	3	2.25	6.42	4.94	2.27
	3,5	1.91	6.51	4.76	2.04
	4	1.73	6.50	4.52	1.74
	5	0.07	4.83	6.60	0.83
	6	0.00	1.52	4.64	0.00





Open area, 0.5Lux floor luminosity

Models	Height (m)				
GR-108/12L/90	2	2.85	7.18	6.04	2.95
GR-109/12L/180	2,5	3.06	7.78	6.55	3.19
	3	3.17	8.29	6.88	3.33
	3,5	3.21	8.72	7.05	3.38
	4	3.21	8.98	7.08	3.34
	5	2.57	9.15	9.53	2.61
	6	0.73	8.58	9.11	1.84
	7	0.15	6.74	8.18	0.00
	8	0.00	2.50	5.52	0.00

Escape route, 1Lux floor luminosity





Models	Height (m)				
GR-151-3/L	2	2.01	5.28	4.27	2.05
	2,5	1.97	5.55	4.29	1.99
	3	1.70	5.65	4.08	1.73
	3,5	1.46	5.63	3.84	1.41
	4	0.30	5.10	3.56	0.83
	5	0.00	2.81	4.60	0.00

Open area, 0.5Lux floor luminosity





Models	Height (m)				
GR-151-3/L	2	2.59	6.57	5.50	2.68
	2,5	2.72	7.11	5.88	2.85
	3	2.78	7.54	6.06	2.90
	3,5	2.77	7.80	6.08	2.85
	4	2.48	7.92	5.97	2.68
	5	0.68	7.71	7.89	1.63
	6	0.17	5.84	6.93	0.00
	7	0.00	2.08	4.24	0.00

### EASY LIGHT

Escape route, 1Lux floor luminosity

Models	Height (m)				
GR-315/15L/A	2	2.35	5.84	5.48	2.14
GR-316/15L/A	2,5	2.23	6.20	5.86	2.18
GR-310/15L/A	3	2.18	6.25	6.07	2.11
GR-312/15L/A	3,5	1.80	6.29	6.07	1.93
	4	1.41	6.19	6.03	1.56
	5	0.00	4.94	5.20	0.00

Open area, 0.5Lux floor luminosity

Models	Height (m)				
GR-315/15L/A	2	2.87	6.99	6.79	2.75
GR-316/15L/A	2,5	3.16	7.76	7.40	2.91
GR-310/15L/A	3	3.22	8.33	7.88	3.01
GR-312/15L/A	3,5	3.11	8.66	8.24	3.05
	4	3.07	8.72	8.44	3.01
	4,5	2.48	8.84	8.55	2.62
	5	1.78	8.46	8.35	1.59
	6	0.00	7.02	7.36	0.00

## EASY LIGHT

Escape route, 1Lux floor luminosity

Models	Height (m)				
GR-315/30L/A	2	3.19	7.74	7.54	3.10
GR-316/30L/A	2,5	3.54	8.59	8.25	3.34
GR-310/30L/A	3	3.82	9.34	8.82	3.51
GR-312/30L/A	3,5	3.89	9.92	9.30	3.61
	4	3.76	10.28	9.68	3.64
	5	3.64	10.44	10.14	3.53
	6	2.86	10.54	10.14	3.14
	7	2.25	10.14	9.96	2.22
	8	0.00	8.69	9.15	0.00

Open area, 0.5Lux floor luminosity

Models	Height (m)				
GR-315/30L/A	2	3.89	9.35	9.14	3.77
GR-316/30L/A	2,5	4.23	10.27	10.11	4.15
GR-310/30L/A	3	4.6	11,19	10,91	4,46
GR-312/30L/A	3,5	4.95	12.03	11.61	4.70
	4	5.25	12.81	12.21	4.87
	5	5.45	14,00	13,20	5,08
	6	5.23	14,61	13,88	5,13
	7	5.13	14,71	14,30	4,99
	8	4.51	14,76	14,30	4,64
	9	3.72	14,75	14,31	3,99
	10	3.09	14.22	14.01	2.87
	11	0.00	12.78	13.19	0.00

Escape route, 1Lux floor luminosity

Models	Height (m)				
GR-315/4P/A	2	3.21	7.51	6.83	2.81
GR-316/4P/A	2,5	3.59	8.48	7.54	3.08
GR-310/4P/A	3	3.73	9.37	8.16	3.28
GR-312/4P/A	3,5	3.71	10.10	8.68	3.45
	4	3.80	10.52	9.11	3.56
	5	3.80	10.51	9.79	3.59
	6	3.22	10.87	10.13	3.36
	7	2.68	10.79	10.16	2.84
	8	0.90	9.86	9.84	1.82
	9	0.00	8.28	9.13	0.00

Open area, 0.5Lux floor luminosity

Models	Height (m)				
GR-315/4P/A	2	3.75	9.06	8.41	3.36
GR-316/4P/A	2,5	4.24	10.01	9.09	3.72
GR-310/4P/A	3	4.67	10.97	9.84	4.04
GR-312/4P/A	3,5	5.00	11.93	10.54	4.30
	4	5.16	12.85	11.19	4.51
	5	5.22	14.27	12.26	4.84
	6	5.40	14.72	13.08	5.00
	7	5.33	14.79	13.73	4.99
	8	4.85	15.17	14.13	4.79
	9	4.12	15.38	14.26	4.40
	10	3.73	15.10	14.19	3.72
	11	1.76	14.21	13.89	2.67
	12	0.27	12.77	13.20	0.00
	13	0.00	11.49	12.33	0.00

Escape route, 1Lux floor luminosity

Models	Height (m)				
GR-315/6P/A	2	3.44	8.09	8.80	3.69
GR-316/6P/A	2,5	3.91	9.10	9.84	4.11
GR-310/6P/A	3	4.20	10.08	10.75	4.46
GR-312/6P/A	3,5	4.48	11.02	11.58	4.75
	4	4.71	11.62	12.31	4.99
	5	5.08	12.73	13.49	5.33
	6	5.25	13.64	14.39	5.43
	7	5.22	14.33	15.04	5.25
	8	4.78	14.76	15.34	4.76
	9	4.27	14.89	15.27	3.91
	10	2.49	14.73	14.78	2.49
	11	0.00	13.96	13.86	0.00

Open area, 0.5Lux floor luminosity

Models	Height (m)				
GR-315/6P/A	2	3.61	8.83	9.54	4.05
GR-316/6P/A	2,5	4.51	10.69	11.63	4.89
GR-310/6P/A	3	5.03	11.77	12.78	5.35
GR-312/6P/A	3,5	5.49	12.80	13.81	5.76
	4	5.79	13.77	14.74	6.13
	5	6.35	15.64	16.42	6.72
	6	6.81	16.81	17.82	7.17
	7	7.15	17.91	18.96	7.49
	8	7.37	18.86	19.92	7.65
	9	7.43	19.70	20.70	7.63
	10	7.35	20.32	21.28	7.39
	11	6.96	20.76	21.62	6.93
	12	6.31	21.00	21.73	6.24
	13	5.91	21.04	21.51	5.22
	14	3.60	20.87	21.01	3.80
	15	0.00	20.22	20.18	0.00

Escape route, 1Lux floor luminosity

Models	Height (m)				
GR-310/12L/90/A	2	2.28	5.75	5.39	2.10
GR-310/12L/180/A	2,5	2.17	6.07	5.74	2.12
	3	2.11	6.08	5.94	2.04
	3,5	1.68	6.16	5.92	1.83
	4	1.35	5.99	5.85	1.42
	5	0.00	4,67	5,95	0,00

Open area, 0.5Lux floor luminosity

Models	Height (m)				
GR-310/12L/90/A	2	2.83	6.90	6.69	2.70
GR-310/12L/180/A	2,5	3.10	7.65	7.28	2.85
	3	3.13	8.19	7.75	2.95
	3,5	3.02	8.48	8.08	2.97
	4	2.98	8.53	8.28	2.91
	5	2.31	8.62	8.34	2.48
	6	0.71	8.09	8.03	1.23
	7	0.00	6.67	6.98	0.00

## EASY LIGHT

Escape route, 1Lux floor luminosity

Models	Height (m)				
GR-308/15L/A	2	2.78	6.74	6.45	2.61
GR-309/15L/A	2,5	3.01	7.43	6.99	2.75
GR-324/15L/24VDC	3	2.92	7.88	7.41	2.81
	3,5	2.85	8.04	7.66	2.79
	4	2.77	8.03	7.84	2.69
	5	1.94	8.04	7.81	2.14
	6	0.02	6.97	7.22	0.27
	7	0.00	4.89	5.32	0.00

Open area, 0.5Lux floor luminosity

Models	Height (m)				
GR-308/15L/A	2	3.30	8.03	7.89	3.24
GR-309/15L/A	2,5	3.67	8.93	8.67	3.52
GR-324/15L/24VDC	3	3.99	9.72	9.31	3.72
	3,5	4.20	10.39	9.84	3.84
	4	4.15	10.89	10.29	3.92
	5	3.99	11.29	10.83	3.92
	6	3.63	11.34	11.01	3.64
	7	2.81	11.33	11.02	3.02
	8	0.81	10.61	10.58	1.58
	9	0.00	9.09	9.56	0.00

Escape route, 1Lux floor luminosity

Models	Height (m)				
GR-324/30L/24VDC/A	2	3.36	8.15	7.99	3.28
	2,5	3.73	9.05	8.76	3.57
	3	4.06	9.85	9.38	3.78
	3,5	4.28	10.54	9.91	3.91
	4	4.26	11.05	10.37	3.99
	5	4.07	11.48	10.94	3.99
	6	3.75	11.50	11.14	3.76
	7	2.91	11.54	11.17	3.16
	8	0.95	10.89	10.79	2.02
	9	0.00	9.29	9.85	0.00

Open area, 0.5Lux floor luminosity

Models	Height (m)				
GR-324/30L/24VDC/A	2	4.14	9.90	9.62	3.98
	2,5	4.49	10.84	10.69	4.40
	3	4.86	11.80	11.55	4.75
	3,5	5.22	12.68	12.32	5.02
	4	5.55	13.50	12.98	5.24
	5	6.03	14.90	14.07	5.52
	6	5.89	15.82	14.93	5.65
	7	5.73	16.17	15.44	5.63
	8	5.61	16.18	15.84	5.43
	9	4.79	16.32	15.78	5.03
	10	4.03	16.23	15.77	4.35
	11	3.43	15.69	15.46	3.21
	12	0.36	14.32	14.65	0.79
13	0.00	12.87	13.50	0.00	

Escape route, 1Lux floor luminosity

Models	Height (m)				
GR-325/6P/24VDC	2	3,61	8,83	9,54	4,05
	2,5	4,37	10,30	11,19	4,71
	3	4,86	11,32	12,30	5,14
	3,5	5,24	12,30	13,25	5,53
	4	5,52	13,30	14,14	5,86
	5	6,03	14,87	15,72	6,39
	6	6,45	16,02	16,98	6,78
	7	6,71	17,01	18,01	7,01
	8	6,83	17,89	18,84	7,03
	9	6,79	18,55	19,49	6,84
	10	6,47	19,03	19,85	6,41
	11	5,81	19,28	19,96	5,74
	12	5,40	19,33	19,72	4,72
	13	3,22	19,11	19,17	3,19
14	0,00	18,38	18,29	0,00	

Open area, 0.5Lux floor luminosity

Models	Height (m)				
GR-325/6P/24VDC	2	3,61	8,83	9,54	4,05
	2,5	4,51	11,04	11,92	5,07
	3	5,41	13,25	14,31	6,08
	3,5	6,15	14,47	15,73	6,60
	4	6,64	15,50	16,85	7,05
	5	7,42	17,49	18,80	7,84
	6	7,99	19,46	20,54	8,47
	7	8,49	20,94	22,10	8,98
	8	8,94	22,09	23,41	9,40
	9	9,27	23,18	24,55	9,72
	10	9,51	24,14	25,53	9,91
	11	9,63	25,04	26,38	9,97
	12	9,65	25,80	27,10	9,86
	14	9,20	26,85	28,02	9,14
	16	8,03	27,31	28,15	7,71
	18	4,81	27,17	27,39	5,25
20	0,00	25,77	25,66	0,00	

Escape route, 1Lux floor luminosity

Models	Height (m)				
GR-1315/15L	2	1.79	4.39	4.31	1.71
GR-1316/15L	2,5	1.92	4.83	4.66	1.82
GR-1310/15L	3	1.98	5.17	4.93	1.87
GR-1312/15L	3,5	1.97	5.42	5.14	1.85
	4	1.86	5.58	5.26	1.74
	5	1.06	5.56	5.22	1.04
	6	0.00	4.31	4.06	0.00

Open area, 0.5Lux floor luminosity

Models	Height (m)				
GR-1315/15L	2	2.16	5.25	5.28	2.10
GR-1316/15L	2,5	2.38	5.83	5.76	2.29
GR-1310/15L	3	2.56	6.34	6.17	2.43
GR-1312/15L	3,5	2.68	6.78	6.51	2.53
	4	2.75	7.13	6.81	2.59
	5	2.74	7.65	7.23	2.56
	6	2.43	7.90	7.41	2.29
	7	1.53	7.83	7.31	1.48
	8	0.00	7.33	6.82	0.00

## EASY LIGHT

Escape route, 1Lux floor luminosity

Models	Height (m)				
GR-1315/30L	2	2.19	5.30	5.38	2.15
GR-1316/30L	2,5	2.41	5.88	5.84	2.33
GR-1310/30L	3	2.58	6.37	6.23	2.46
GR-1312/30L	3,5	2.71	6.80	6.57	2.57
	4	2.79	7.16	6.86	2.63
	5	2.78	7.69	7.28	2.61
	6	2.48	7.95	7.48	2.34
	7	1.61	7.88	7.40	1.57
	8	0.00	7.43	6.99	0.00

Models	Height (m)				
GR-1315/30L	2	2.62	6.32	6.58	2.64
GR-1316/30L	2,5	2.91	7.04	7.19	2.88
GR-1310/30L	3	3.17	7.68	7.71	3.08
GR-1312/30L	3,5	3.39	8.25	8.17	3.25
	4	3.56	8.77	8.58	3.40
	5	3.82	9.65	9.29	3.61
	6	3.95	10.33	9.84	3.70
	7	3.91	10.82	10.25	3.65
	8	3.68	11.13	10.48	3.44
	9	3.15	11.24	10.53	2.98
	10	2.08	11.10	10.37	2.00
	11	0.00	10.68	9.97	0.00

Escape route, 1Lux floor luminosity

Models	Height (m)				
GR-1315/4P	2	3.02	7.28	6.80	2.79
GR-1316/4P	2,5	3.31	8.09	7.51	3.05
GR-1310/4P	3	3.53	8.77	8.10	3.25
GR-1312/4P	3,5	3.68	9.33	8.60	3.39
	4	3.76	9.80	9.02	3.48
	5	3.73	10.45	9.62	3.53
	6	3.38	10.69	9.94	3.31
	7	2.66	10.59	10.01	2.59
	8	0.53	10.06	9.68	0.45
	9	0.00	8.42	7.80	0.00

Open area, 0.5Lux floor luminosity

Models	Height (m)				
GR-1315/4P	2	3.62	8.64	8.16	3.39
GR-1316/4P	2,5	4.02	9.67	9.08	3.75
GR-1310/4P	3	4.36	10.57	9.88	4.05
GR-1312/4P	3,5	4.65	11.37	10.57	4.30
	4	4.88	12.07	11.19	4.51
	5	5.20	13.24	12.21	4.81
	6	5.32	14.12	13.00	4.97
	7	5.27	14.72	13.58	4.99
	8	5.00	15.04	13.95	4.83
	9	4.45	15.09	14.15	4.37
	10	3.61	14.92	14.14	3.55
	11	1.92	14.43	13.85	1.83
	12	0.00	13.49	13.20	0.00

Escape route, 1Lux floor luminosity

Models	Height (m)				
GR-1315/6P	2	2.92	6.98	6.88	2.84
GR-1316/6P	2,5	3.24	7.79	7.61	3.11
GR-1310/6P	3	3.51	8.51	8.24	3.34
GR-1312/6P	3,5	3.72	9.14	8.78	3.52
	4	3.89	9.70	9.25	3.65
	5	4.08	10.58	10.00	3.81
	6	4.07	11.18	10.50	3.79
	7	3.86	11.52	10.77	3.59
	8	3.38	11.59	10.78	3.15
	9	2.33	11.40	10.58	2.23
	10	0.00	10.87	10.10	0.00

Open area, 0.5Lux floor luminosity

Models	Height (m)				
GR-1315/6P	2	3.35	7.97	7.93	3.29
GR-1316/6P	2,5	3.88	9.27	9.18	3.80
GR-1310/6P	3	4.24	10.16	10.00	4.11
GR-1312/6P	3,5	4.56	10.96	10.72	4.39
	4	4.84	11.70	11.36	4.62
	5	5.28	12.98	12.47	5.00
	6	5.57	14.05	13.36	5.25
	7	5.74	14.90	14.09	5.38
	8	5.78	15.56	14.63	5.39
	9	5.68	16.02	15.04	5.28
	10	5.41	16.30	15.25	5.05
	11	4.94	16.40	15.26	4.63
	12	4.15	16.29	15.16	3.98
	13	2.78	15.99	14.86	2.65
	14	0.00	15.44	14.38	0.00

Escape route, 1Lux floor luminosity





Models	Height (m)				
GR-1310/12L/90	2	1.76	4.33	4.24	1.68
GR-1310/12L/180	2,5	1.88	4.76	4.58	1.78
	3	1.94	5.09	4.85	1.82
	3,5	1.91	5.33	5.04	1.79
	4	1.77	5.46	5.15	1.67
	5	0.81	5.39	5.06	0.81
	6	0.00	4.05	3.90	0.00

Open area, 0.5Lux floor luminosity





Models	Height (m)				
GR-1310/12L/90	2	2.13	5.17	5.20	2.07
GR-1310/12L/180	2,5	2.35	5.76	5.67	2.25
	3	2.51	6.25	6.07	2.39
	3,5	2.63	6.68	6.41	2.48
	4	2.70	7.02	6.69	2.53
	5	2.65	7.51	7.09	2.48
	6	2.28	7.72	7.24	2.17
	7	1.18	7.59	7.09	1.18
	8	0.00	6.51	6.04	0.00

## EASY LIGHT

Escape route, 1Lux floor luminosity





Models	Height (m)				
GR-1324/30L/24VDC	2	2.95	7.20	7.11	2.89
	2.5	3.22	7.94	7.81	3.17
	3	3.44	8.54	8.39	3.37
	3.5	3.62	9.09	8.93	3.52
	4	3.73	9.53	9.36	3.63
	5	3.79	10.27	9.98	3.68
	6	3.59	10.65	10.36	3.50
	7	3.06	10.73	10.43	3.00
	8	1.86	10.44	10.15	1.77
9	0.00	9.72	9.51	0.00	

Open area, 0.5Lux floor luminosity





Models	Height (m)				
GR-1324/30L/24VDC	2	3.60	8.76	8.67	3.53
	2.5	3.97	9.67	9.55	3.89
	3	4.27	10.44	10.28	4.18
	3.5	4.54	11.18	10.99	4.45
	4	4.76	11.81	11.58	4.67
	5	5.13	12.91	12.67	4.98
	6	5.32	13.78	13.50	5.17
	7	5.36	14.48	14.08	5.20
	8	5.22	14.93	14.52	5.06
	9	4.86	15.16	14.74	4.73
	10	4.24	15.17	14.74	4.12
	11	3.13	14.93	14.49	3.01
12	0.00	14.36	13.99	0.00	

## WEATHER LIGHT





Escape route, 1Lux floor luminosity

Models	Height (m)				
GR-940/15L	2	2.29	5.84	5.70	2.27
GR-941/15L	2,5	2.37	6.29	6.20	2.37
	3	2.35	6.56	6.53	2.35
	3,5	2.18	6.70	6.72	2.19
	4	1.98	6.72	6.74	1.80
	5	0.00	6.15	6.14	0.00





Open area, 0.5Lux floor luminosity

Models	Height (m)				
GR-940/15L	2	2.87	7.09	6.83	2.81
GR-941/15L	2,5	3.10	7.79	7.58	3.06
	3	3.23	8.38	8.20	3.23
	3,5	3.31	8.81	8.69	3.32
	4	3.32	9.11	9.05	3.34
	5	3.04	9.43	9.46	3.07
	6	2.55	9.36	9.42	2.12
	7	0.00	8.70	8.76	0.00

Escape route, 1Lux floor luminosity

Models	Height (m)				
GR-935/6P	2	3.72	9.05	8.62	3.57
GR-936/6P	2,5	4.09	9.99	9.55	3.96
	3	4.40	10.80	10.39	4.29
	3,5	4.65	11.52	11.15	4.56
	4	4.83	12.17	11.85	4.77
	5	5.03	13.20	12.97	5.04
	6	5.08	13.84	13.74	5.09
	7	4.88	14.22	14.23	4.89
	8	4.46	14.37	14.44	4.36
	9	4.00	14.26	14.28	3.31
	10	2.19	13.73	13.75	1.08
	11	0.00	12.50	12.42	0.00

Open area, 0.5Lux floor luminosity

Models	Height (m)				
GR-935/6P	2	4.05	10.17	9.69	4.03
GR-936/6P	2,5	4.97	12.04	11.48	4.76
	3	5.37	13.11	12.52	5.17
	3,5	5.73	14.03	13.43	5.55
	4	6.06	14.86	14.29	5.90
	5	6.57	16.33	15.82	6.46
	6	6.90	17.59	17.17	6.85
	7	7.09	18.57	18.25	7.09
	8	7.17	19.29	19.09	7.20
	9	7.11	19.78	19.71	7.14
	10	6.84	20.11	20.14	6.87
	11	6.43	20.29	20.38	6.39
	12	6.03	20.30	20.39	5.55
	13	5.41	20.06	20.10	4.30
	14	3.21	19.49	19.56	2.06
	15	0.00	18.68	18.69	0.00

## WEATHER LIGHT

Escape route, 1Lux floor luminosity

Models	Height (m)				
GR-900/30L/SC	2	2.15	5.56	5.45	2.14
	2,5	2.20	5.94	5.88	2.21
	3	2.12	6.15	6.15	2.12
	3,5	1.92	6.22	6.25	1.86
	4	1.65	6.14	6.14	1.28
5	0.00	4.55	4.58	0.00	

Open area, 0.5Lux floor luminosity

Models	Height (m)				
GR-900/30L/SC	2	2.73	6.77	6.55	2.68
	2,5	2.92	7.44	7.26	2.90
	3	3.03	7.96	7.82	3.03
	3,5	3.07	8.32	8.24	3.09
	4	3.03	8.55	8.53	3.05
	5	2.66	8.75	8.80	2.59
	6	1.41	8.43	8.51	1.09
7	0.00	6.54	6.68	0.00	

Escape route, 1Lux floor luminosity

Models	Height (m)				
GR-935/15L	2	2.47	5.82	5.67	2.32
GR-936/15L	2,5	2.73	6,56	6,25	2,53
	3	2,93	7,18	6,73	2,69
	3,5	3,06	7,71	7,14	2,81
	4	3,13	8,13	7,48	2,89
	5	3,09	8,69	7,99	2,88
	6	2,71	8,89	8,23	2,61
	7	1,74	8,77	8,18	1,79
	8	0,00	8,17	7,76	0,00

Open area, 0.5Lux floor luminosity

Models	Height (m)				
GR-935/15L	2	2,88	6,70	6,89	2,82
GR-936/15L	2,5	3,25	7,63	7,61	3,10
	3	3,57	8,46	8,23	3,34
	3,5	3,83	9,20	8,78	3,55
	4	4,04	9,85	9,27	3,72
	5	4,31	10,91	10,11	3,97
	6	4,42	11,70	10,76	4,08
	7	4,34	12,23	11,23	4,05
	8	4,06	12,49	11,52	3,82
	9	3,44	12,52	11,61	3,34
	10	2,27	12,29	11,48	2,31
	11	0,00	11,77	11,08	0,00

Escape route, 1Lux floor luminosity

Models	Height (m)				
GR-935/30L	2	2,77	6,52	6,43	2,65
GR-936/30L	2,5	3,10	7,36	7,11	2,91
	3	3,37	8,09	7,70	3,13
	3,5	3,58	8,74	8,21	3,31
	4	3,74	9,29	8,67	3,44
	5	4,49	11,25	10,47	4,12
	6	4,62	12,09	11,15	4,23
	7	4,55	12,68	11,64	4,17
	8	4,23	13,03	11,91	3,90
	9	3,53	13,07	11,97	3,34
	10	2,10	12,84	11,79	2,07
	11	0,00	12,25	11,27	0,00

Open area, 0.5Lux floor luminosity

Models	Height (m)				
GR-935/30L	2	3,26	7,61	7,74	3,22
GR-936/30L	2,5	3,95	9,24	9,37	3,88
	3	4,36	10,23	10,20	4,21
	3,5	4,73	11,13	10,95	4,51
	4	5,06	11,98	11,64	4,77
	5	5,61	13,47	12,84	5,22
	6	6,03	14,75	13,86	5,56
	7	6,33	15,82	14,73	5,80
	8	6,49	16,72	15,45	5,94
	9	6,52	17,44	16,03	5,96
	10	6,41	17,98	16,47	5,86
	11	6,10	18,34	16,76	5,61
	12	5,56	18,48	16,90	5,14
	13	3,22	18,20	16,67	3,15
	14	0,00	16,34	14,85	0,00



## WEATHER LIGHT

Escape route, 1Lux floor luminosity

Models	Height (m)				
GR-1935/15L	2	2,15	5,17	4,91	1,98
GR-1936/15L	2,5	2,32	5,76	5,37	2,14
GR-1938/15L	3	2,42	6,23	5,74	2,23
GR-1939/15L	3,5	2,43	6,56	6,03	2,26
GR-1938/15L/ADR	4	2,37	6,79	6,24	2,22
GR-1939/15L/ADR	5	2,71	8,09	7,45	2,57
	6	2,10	8,12	7,55	2,09
	7	0,00	7,74	7,31	0,00

Open area, 0.5Lux floor luminosity

Models	Height (m)				
GR-1935/15L	2	2,77	6,46	6,57	2,68
GR-1936/15L	2,5	3,11	7,35	7,24	2,94
GR-1938/15L	3	3,40	8,13	7,81	3,17
GR-1939/15L	3,5	3,63	8,81	8,33	3,35
GR-1938/15L/ADR	4	3,81	9,40	8,79	3,50
GR-1939/15L/ADR	5	4,01	10,36	9,55	3,69
	6	4,03	11,01	10,11	3,73
	7	3,84	11,39	10,48	3,60
	8	3,35	11,49	10,62	3,21
	9	2,33	11,31	10,55	2,36
	10	0,00	10,84	10,19	0,00

Escape route, 1Lux floor luminosity

Models	Height (m)				
GR-1935/30L	2	2,88	6,76	6,71	2,77
GR-1936/30L	2,5	3,23	7,63	7,43	3,05
GR-1938/30L	3	3,52	8,41	8,05	3,29
GR-1939/30L	3,5	3,76	9,09	8,60	3,48
GR-1938/30L/ADR	4	3,95	9,70	9,09	3,64
GR-1939/30L/ADR	5	4,20	10,69	9,90	3,84
	6	4,22	11,41	10,49	3,87
	7	4,02	11,86	10,85	3,69
	8	3,45	12,00	10,97	3,23
	9	2,25	11,82	10,85	2,20
	10	0,00	11,29	10,39	0,00

Open area, 0.5Lux floor luminosity

Models	Height (m)				
GR-1935/30L	2	3,26	7,61	7,74	3,22
GR-1936/30L	2,5	3,80	8,89	8,94	3,70
GR-1938/30L	3	4,18	9,84	9,73	4,01
GR-1939/30L	3,5	4,53	10,70	10,44	4,29
GR-1938/30L/ADR	4	4,83	11,49	11,09	4,53
GR-1939/30L/ADR	5	5,33	12,90	12,21	4,93
	6	5,69	14,07	13,15	5,22
	7	5,90	15,04	13,92	5,41
	8	5,98	15,82	14,55	5,47
	9	5,90	16,40	15,03	5,39
	10	5,62	16,78	15,35	5,16
	11	5,09	16,94	15,48	4,70
	12	4,20	16,89	15,46	3,94
	13	2,58	16,62	15,21	2,56
	14	0,00	16,06	14,74	0,00

Escape route, 1Lux floor luminosity

Models	Height (m)				
GR-1938/4P	2	2,82	6,58	6,43	2,64
GR-1939/4P	2,5	3,17	7,47	7,09	2,90
	3	3,46	8,25	7,68	3,11
	3,5	3,70	8,94	8,18	3,28
	4	3,86	9,54	8,62	3,40
	5	4,63	11,57	10,40	4,06
	6	4,75	12,48	11,05	4,15
	7	4,68	13,07	11,47	4,11
	8	4,36	13,41	11,70	3,82
	9	3,57	13,43	11,78	3,22
	10	2,16	13,20	11,61	1,96
	11	0,00	12,58	11,07	0,00

Open area, 0.5Lux floor luminosity

Models	Height (m)				
GR-1938/4P	2	3,31	7,62	7,87	3,24
GR-1939/4P	2,5	4,01	9,26	9,45	3,89
	3	4,45	10,31	10,25	4,22
	3,5	4,84	11,29	10,96	4,51
	4	5,19	12,18	11,63	4,76
	5	5,78	13,77	12,82	5,20
	6	6,23	15,13	13,82	5,52
	7	6,52	16,29	14,65	5,73
	8	6,69	17,25	15,34	5,85
	9	6,71	18,00	15,88	5,89
	10	6,58	18,52	16,26	5,80
	11	6,26	18,88	16,50	5,53
	12	4,75	18,96	16,66	4,31
	13	3,27	18,69	16,47	3,03
	14	0,00	18,17	16,01	0,00

## BAU LIGHT

Escape route, 1Lux floor luminosity

Models	Height (m)				
GR-751/ST/LP/LL 1h	2	3,54	8,75	8,56	3,46
GR-751/ST/LP/LL/ADR 1h	2,5	3,90	9,58	9,51	3,71
GR-751/ST/LP/LL/WL 1h	3	4,11	10,24	10,10	3,93
	3,5	3,34	10,98	10,54	4,06
	4	3,50	11,02	11,13	4,12
	5	3,70	9,40	11,48	4,03
	6	3,94	9,25	11,73	3,60
	7	2,72	10,40	11,45	2,75
	8	0,00	10,15	10,71	0,00

Open area, 0.5Lux floor luminosity

Models	Height (m)				
GR-751/ST/LP/LL 1h	2	4,37	10,63	10,45	4,28
GR-751/ST/LP/LL/ADR 1h	2,5	4,79	11,72	11,48	4,74
GR-751/ST/LP/LL/WL 1h	3	5,12	12,69	12,43	5,05
	3,5	5,49	13,50	13,38	5,27
	4	5,91	14,18	13,84	5,55
	5	4,70	15,62	14,85	5,74
	6	4,62	15,42	15,75	5,86
	7	5,20	13,38	16,25	5,73
	8	5,59	13,60	16,50	5,35
	9	5,24	13,70	16,45	4,71
	10	3,75	14,82	16,14	3,79
	11	2,20	14,20	15,38	1,82
	12	0,00	13,16	14,41	0,00

Escape route, 1Lux floor luminosity

Models	Height (m)				
GR-751/ST/LP/LL 3h	2	2,96	7,09	6,92	2,78
GR-751/ST/LP/LL/ADR 3h	2,5	2,35	7,81	7,42	2,87
GR-751/ST/LP/LL/WL 3h	3	2,31	7,71	7,87	2,93
	3,5	2,60	6,69	8,12	2,86
	4	2,79	6,80	8,25	2,67
	5	1,87	7,41	8,07	1,90
	6	0,00	6,58	7,20	0,00

Open area, 0.5Lux floor luminosity

Models	Height (m)				
GR-751/ST/LP/LL 3h	2	3,54	8,75	8,56	3,46
GR-751/ST/LP/LL/ADR 3h	2,5	3,90	9,58	9,48	3,71
GR-751/ST/LP/LL/WL 3h	3	4,11	10,24	10,10	3,93
	3,5	3,34	10,98	10,54	4,06
	4	3,50	11,02	11,11	4,12
	5	3,70	9,40	11,48	4,03
	6	3,88	9,25	11,73	3,60
	7	2,72	10,40	11,45	2,73
	8	0,00	10,15	10,71	0,00

Escape route, 1Lux floor luminosity

Models	Height (m)				
GR-751/ST/LP/LL 8h	2	1,18	3,05	3,68	1,06
GR-751/ST/LP/LL/ADR 8h	2,5	0,35	3,19	3,41	0,25
GR-751/ST/LP/LL/WL 8h	3	0,00	2,20	2,30	0,00

Open area, 0.5Lux floor luminosity

Models	Height (m)				
GR-751/ST/LP/LL 8h	2	1,52	4,96	4,97	1,82
GR-751/ST/LP/LL/ADR 8h	2,5	1,76	4,26	5,18	1,67
GR-751/ST/LP/LL/WL 8h	3	1,37	4,51	5,16	1,31
	3,5	0,33	4,50	4,84	0,46
	4	0,00	3,27	4,00	0,00

## BAU LIGHT

Escape route, 1Lux floor luminosity

Models	Height (m)				
GR-753/ST/LP/HL 1h	2	3,72	9,14	8,93	3,68
GR-753/ST/LP/HL/ADR 1h	2,5	4,04	10,04	9,90	4,04
GR-753/ST/LP/HL/WL 1h	3	4,48	10,76	10,53	4,21
GR-753/CBS/24V/ADR/LP/HL	3,5	4,64	11,39	11,31	4,31
GR-753/CBS/LP/HL	4	3,58	12,20	11,59	4,38
	5	3,78	11,59	12,26	4,42
	6	4,25	10,26	12,56	4,13
	7	3,82	10,61	12,52	3,51
	8	2,38	11,24	12,05	2,37
	9	0,00	10,00	11,19	0,00

Open area, 0.5Lux floor luminosity

Models	Height (m)				
GR-753/ST/LP/HL 1h	2	4,57	11,10	10,90	4,46
GR-753/ST/LP/HL/ADR 1h	2,5	5,02	12,22	12,03	4,94
GR-753/ST/LP/HL/WL 1h	3	5,38	13,26	12,98	5,26
GR-753/CBS/24V/ADR/LP/HL	3,5	5,69	14,15	13,94	5,66
GR-753/CBS/LP/HL	4	6,13	14,89	14,75	5,79
	5	6,55	16,18	16,06	6,13
	6	5,28	17,40	16,86	6,28
	7	5,30	16,50	17,27	6,26
	8	5,85	14,32	17,53	6,02
	9	6,07	13,94	17,89	5,59
	10	5,18	15,12	17,70	4,89
	11	3,83	16,22	17,31	3,85
	12	1,95	15,41	16,53	1,62
	13	0,00	14,22	15,51	0,00

Escape route, 1Lux floor luminosity

Models	Height (m)				
GR-753/ST/LP/HL 3h	2	3,46	8,58	8,40	3,40
GR-753/ST/LP/HL/ADR 3h	2,5	3,85	9,38	9,31	3,64
GR-753/ST/LP/HL/WL 3h	3	4,05	10,03	9,94	3,80
	3,5	3,15	10,83	10,25	3,90
	4	3,26	10,57	10,83	3,99
	5	3,67	8,98	11,05	3,83
	6	3,66	9,18	11,30	3,34
	7	2,36	10,30	10,92	2,35
	8	0,00	9,35	10,06	0,00

Open area, 0.5Lux floor luminosity

Models	Height (m)				
GR-753/ST/LP/HL 3h	2	4,29	10,42	10,25	4,20
GR-753/ST/LP/HL/ADR 3h	2,5	4,69	11,50	11,24	4,64
GR-753/ST/LP/HL/WL 3h	3	5,01	12,44	12,21	4,96
	3,5	5,41	13,21	13,13	5,12
	4	5,64	13,86	13,62	5,41
	5	4,49	15,40	14,58	5,52
	6	4,59	15,19	15,21	5,65
	7	5,15	12,61	15,62	5,46
	8	5,42	13,44	15,99	5,03
	9	4,59	13,59	15,82	4,32
	10	3,20	14,14	15,35	3,15
	11	0,00	13,16	14,56	0,00

Escape route, 1Lux floor luminosity

Models	Height (m)				
GR-753/ST/LP/HL 8h	2	1,79	6,16	5,83	2,21
GR-753/ST/LP/HL/ADR 8h	2,5	1,89	5,93	6,18	2,24
GR-753/ST/LP/HL/WL 8h	3	2,14	5,15	6,35	2,11
	3,5	2,04	5,32	6,36	1,81
	4	1,30	5,66	6,16	1,27
	5	0,00	3,81	4,59	0,00

Open area, 0.5Lux floor luminosity

Models	Height (m)				
GR-753/ST/LP/HL 8h	2	3,08	7,51	7,42	2,90
GR-753/ST/LP/HL/ADR 8h	2,5	3,26	8,16	8,08	3,07
GR-753/ST/LP/HL/WL 8h	3	2,65	8,95	8,47	3,17
	3,5	2,66	8,44	8,71	3,18
	4	2,93	7,18	8,86	3,08
	5	2,67	7,59	8,98	2,52
	6	1,24	7,76	8,44	1,03
	7	0,00	5,38	6,76	0,00

Escape route, 1Lux floor luminosity

Models	Height (m)				
GR-751/CBS/LP/LL	2	3,11	7,64	7,59	2,95
GR-751/CBS/24V/ADR/LP/LL	2,5	3,36	8,30	8,23	3,14
	3	2,67	9,07	8,61	3,24
	3,5	2,68	8,84	8,86	3,29
	4	2,96	7,45	9,13	3,20
	5	2,99	7,63	9,28	2,70
	6	1,59	8,34	8,78	1,53
	7	0,00	6,24	7,58	0,00

Open area, 0.5Lux floor luminosity

Models	Height (m)				
GR-751/CBS/LP/LL	2	3,82	9,35	9,15	3,77
GR-751/CBS/24V/ADR/LP/LL	2,5	4,15	10,29	10,11	4,10
	3	4,56	11,04	10,90	4,30
	3,5	4,72	11,69	11,58	4,43
	4	3,72	12,47	11,83	4,56
	5	3,81	12,49	12,58	4,64
	6	4,36	10,68	12,97	4,39
	7	4,23	10,72	13,16	3,89
	8	2,94	11,84	12,82	2,96
	9	0,00	11,42	12,06	0,00

## LINEAR LIGHT

Escape route, 1Lux floor luminosity

Models	Height (m)				
KLIN-20/ST 1h	2	4,58	10,46	7,04	2,76
KLIN-20/ST/ADR 1h	2,5	5,11	12,03	7,53	2,91
KLIN-20/ST/WL 1h	3	5,41	13,39	7,94	2,97
	3,5	5,70	14,41	8,22	2,93
	4	3,02	13,92	8,36	2,81
	5	1,99	12,77	8,29	2,21
	6	0,00	8,09	7,70	0,00

Open area, 0.5Lux floor luminosity

Models	Height (m)				
KLIN-20/ST 1h	2	5,23	12,03	8,69	3,52
KLIN-20/ST/ADR 1h	2,5	6,01	13,65	9,52	3,76
KLIN-20/ST/WL 1h	3	6,69	15,36	10,15	3,96
	3,5	7,18	16,91	10,62	4,09
	4	7,46	18,32	11,05	4,15
	5	8,04	20,42	11,63	4,09
	6	3,99	19,26	11,83	3,79
	7	2,86	18,00	11,66	3,16
	8	1,07	11,99	11,17	1,75
	9	0,00	10,37	10,27	0,00

Escape route, 1Lux floor luminosity

Models	Height (m)				
KLIN-20/ST 3h	2	3,59	8,90	5,27	1,97
KLIN-20/ST/ADR 3h	2,5	2,11	9,77	5,51	1,91
KLIN-20/ST/WL 3h	3	1,74	8,67	5,57	1,71
	3,5	0,98	6,12	5,43	1,26
	4	0,00	5,34	5,09	0,00

Open area, 0.5Lux floor luminosity

Models	Height (m)				
KLIN-20/ST 3h	2	4,45	10,22	6,74	2,61
KLIN-20/ST/ADR 3h	2,5	4,84	11,73	7,20	2,71
KLIN-20/ST/WL 3h	3	5,15	12,95	7,54	2,72
	3,5	2,93	13,72	7,74	2,63
	4	2,60	12,72	7,80	2,44
	5	1,13	8,30	7,53	1,54
	6	0,00	6,76	6,60	0,00

## OLYMPUS LIGHT

Escape route, 1Lux floor luminosity

Models	Height (m)				
OLY-500	2	2,71	6,88	6,55	2,59
OLY-500/WP	2,5	2,83	7,43	7,06	2,71
	3	2,85	7,79	7,44	2,74
	3,5	2,77	8,02	7,65	2,68
	4	2,60	8,09	7,79	2,52
	5	1,80	7,83	7,56	1,71
	6	0,00	6,99	6,78	0,00

Open area, 0.5Lux floor luminosity

Models	Height (m)				
OLY-500	2	3,41	8,30	7,96	3,27
OLY-500/WP	2,5	3,69	9,24	8,76	3,53
	3	3,87	9,92	9,49	3,72
	3,5	3,98	10,45	9,96	3,82
	4	4,02	10,83	10,37	3,89
	5	3,89	11,32	10,84	3,78
	6	3,46	11,40	10,99	3,39
	7	2,58	11,09	10,73	2,51
	8	0,00	10,37	10,10	0,00

Escape route, 1Lux floor luminosity

Models	Height (m)				
OLY-1004 1h	2	4,02	9,45	9,19	3,84
OLY-1004/WP 1h	2,5	4,45	10,68	10,26	4,22
OLY-1004/WL 1h	3	4,76	11,71	11,14	4,53
OLY-1004/WP/WL 1h	3,5	4,99	12,55	11,88	4,75
	4	5,16	13,21	12,58	4,93
	5	5,34	14,17	13,49	5,12
	6	5,31	14,78	14,13	5,10
	7	5,07	15,10	14,46	4,90
	8	4,59	15,11	14,53	4,45
	9	3,77	14,83	14,29	3,62
	10	2,27	14,27	13,80	2,15
	11	0,00	13,33	12,95	0,00

Open area, 0.5Lux floor luminosity

Models	Height (m)				
OLY-1004 1h	2	4,40	10,25	10,11	4,24
OLY-1004/WP 1h	2,5	5,34	12,45	12,24	5,13
OLY-1004/WL 1h	3	5,85	13,82	13,37	5,57
OLY-1004/WP/WL 1h	3,5	6,26	15,02	14,44	5,94
	4	6,59	16,09	15,36	6,29
	5	7,07	17,81	16,88	6,74
	6	7,38	19,06	18,13	7,06
	7	7,54	19,98	19,02	7,23
	8	7,54	20,65	19,74	7,26
	9	7,40	21,12	20,15	7,14
	10	7,12	21,36	20,48	6,90
	11	6,65	21,39	20,60	6,47
	12	5,98	21,23	20,40	5,78
	14	3,48	20,27	19,61	3,33
	16	0,00	18,33	17,80	0,00

## OLYMPUS LIGHT

Escape route, 1Lux floor luminosity

Models	Height (m)				
OLY-1004 3h	2	3,85	9,11	8,80	3,65
OLY-1004/WP 3h	2,5	4,22	10,25	9,80	4,02
OLY-1004/WL 3h	3	4,49	11,20	10,58	4,27
OLY-1004/WP/WL 3h	3,5	4,68	11,91	11,34	4,47
	4	4,82	12,49	11,87	4,60
	5	4,91	13,29	12,69	4,73
	6	4,77	13,77	13,14	4,61
	7	4,40	13,89	13,38	4,27
	8	3,72	13,72	13,19	3,56
	9	2,44	13,22	12,78	2,33
	10	0,00	12,35	12,00	0,00

Open area, 0.5Lux floor luminosity

Models	Height (m)				
OLY-1004 3h	2	4,40	10,25	10,11	4,24
OLY-1004/WP 3h	2,5	5,12	12,01	11,71	4,90
OLY-1004/WL 3h	3	5,59	13,30	12,82	5,29
OLY-1004/WP/WL 3h	3,5	5,94	14,42	13,80	5,67
	4	6,23	15,41	14,62	5,93
	5	6,63	16,90	16,11	6,34
	6	6,87	17,98	17,10	6,57
	7	6,94	18,74	17,91	6,69
	8	6,84	19,28	18,42	6,59
	9	6,59	19,58	18,76	6,39
	10	6,16	19,64	18,92	6,00
	11	5,50	19,49	18,73	5,32
	12	4,52	19,09	18,44	4,34
	13	2,87	18,49	17,91	2,76
	14	0,00	17,59	17,11	0,00

Escape route, 1Lux floor luminosity

Models	Height (m)				
OLY-1004 8h	2	2,66	6,77	6,77	2,54
OLY-1004/WP 8h	2,5	2,77	7,30	7,30	2,65
OLY-1004/WL 8h	3	2,78	7,64	7,64	2,67
OLY-1004/WP/WL 8h	3,5	2,68	7,84	7,84	2,59
	4	2,48	7,88	7,88	2,41
	5	1,57	7,56	7,56	1,50
	6	0,00	6,62	6,62	0,00

Open area, 0.5Lux floor luminosity

Models	Height (m)				
OLY-1004 8h	2	3,36	8,19	7,85	3,22
OLY-1004/WP 8h	2,5	3,62	9,10	8,62	3,47
OLY-1004/WL 8h	3	3,79	9,76	9,32	3,65
OLY-1004/WP/WL 8h	3,5	3,89	10,26	9,78	3,74
	4	3,92	10,62	10,18	3,79
	5	3,75	11,07	10,61	3,65
	6	3,27	11,09	10,68	3,21
	7	2,27	10,71	10,37	2,22
	8	0,00	9,89	9,65	0,00

Escape route, 1Lux floor luminosity

Models	Height (m)				
OLY-1024 1h	2	7,45	17,54	7,32	2,91
OLY-1024/WP 1h	2,5	8,29	19,79	7,89	3,11
OLY-1024/WL 1h	3	8,93	21,73	8,39	3,29
OLY-1024/WP/WL 1h	3,5	9,40	23,35	8,79	3,46
	4	9,68	24,72	9,15	3,65
	5	8,96	26,66	9,82	3,97
	6	3,73	24,33	10,60	4,12
	7	2,48	21,21	11,19	4,05
	8	0,00	11,82	11,56	0,00

Open area, 0.5Lux floor luminosity

Models	Height (m)				
OLY-1024 1h	2	8,42	19,88	9,20	3,66
OLY-1024/WP 1h	2,5	9,52	22,52	9,94	3,94
OLY-1024/WL 1h	3	10,48	24,96	10,57	4,19
OLY-1024/WP/WL 1h	3,5	11,25	27,14	11,12	4,39
	4	11,89	29,10	11,65	4,57
	5	12,83	32,34	12,47	4,91
	6	13,15	34,82	13,17	5,30
	7	11,89	36,63	13,85	5,59
	8	5,91	37,41	14,63	5,78
	9	4,66	32,33	15,35	5,83
	10	3,36	29,64	15,88	5,69
	11	0,37	17,68	16,26	0,00
	12	0,00	14,95	12,38	0,00

Escape route, 1Lux floor luminosity

Models	Height (m)				
OLY-1024 3h	2	7,14	16,87	6,92	2,74
OLY-1024/WP 3h	2,5	7,89	18,98	7,46	2,93
OLY-1024/WL 3h	3	8,44	20,81	7,91	3,09
OLY-1024/WP/WL 3h	3,5	8,81	22,23	8,28	3,28
	4	8,93	23,40	8,61	3,47
	5	4,13	24,98	9,34	3,72
	6	2,82	20,61	10,06	3,78
	7	1,04	12,00	10,50	3,42
	8	0,00	9,20	7,65	0,00

Open area, 0.5Lux floor luminosity

Models	Height (m)				
OLY-1024 3h	2	8,08	19,06	8,71	3,46
OLY-1024/WP 3h	2,5	9,11	21,64	9,38	3,73
OLY-1024/WL 3h	3	9,97	23,96	9,98	3,95
OLY-1024/WP/WL 3h	3,5	10,67	25,99	10,52	4,14
	4	11,24	27,85	10,99	4,30
	5	11,94	30,74	11,74	4,67
	6	11,61	32,90	12,39	5,03
	7	6,00	34,24	13,15	5,25
	8	4,60	30,57	13,91	5,35
	9	3,35	27,88	14,49	5,27
	10	1,00	16,54	14,89	4,59
	11	0,00	13,74	11,41	0,00

## OLYMPUS LIGHT

Escape route, 1Lux floor luminosity

Models	Height (m)				
OLY-1024 8h	2	4,95	12,54	4,66	1,85
OLY-1024/WP 8h	2,5	4,73	13,58	4,99	2,02
OLY-1024/WL 8h	3	2,01	12,90	5,37	2,10
OLY-1024/WP/WL 8h	3,5	1,40	11,21	5,70	2,09
	4	0,11	6,37	5,90	1,84
	5	0,00	3,48	3,58	0,00

Open area, 0.5Lux floor luminosity

Models	Height (m)				
OLY-1024 8h	2	5,77	14,31	5,92	2,33
OLY-1024/WP 8h	2,5	6,25	15,93	6,34	2,49
OLY-1024/WL 8h	3	6,39	17,19	6,70	2,68
OLY-1024/WP/WL 8h	3,5	5,81	18,13	7,04	2,85
	4	3,18	18,66	7,42	2,95
	5	1,91	15,71	8,08	2,95
	6	0,00	8,05	6,98	0,00

Escape route, 1Lux floor luminosity

Models	Height (m)				
OLY-1004/LT/WP 1h	2	4,02	9,45	9,19	3,84
OLY-1004/LF/WP 1h	2,5	4,45	10,68	10,26	4,22
	3	4,76	11,71	11,14	4,53
	3,5	4,99	12,55	11,88	4,75
	4	5,16	13,21	12,58	4,93
	5	5,34	14,17	13,49	5,12
	6	5,31	14,78	14,13	5,10
	7	5,07	15,10	14,46	4,90
	8	4,59	15,11	14,53	4,45
	9	3,77	14,83	14,29	3,62
	10	2,27	14,27	13,80	2,15
	11	0,00	13,33	12,95	0,00

Open area, 0.5Lux floor luminosity

Models	Height (m)				
OLY-1004/LT/WP 1h	2	4,40	10,25	10,11	4,24
OLY-1004/LF/WP 1h	2,5	5,34	12,45	12,24	5,13
	3	5,85	13,82	13,37	5,57
	3,5	6,26	15,02	14,44	5,94
	4	6,59	16,09	15,36	6,29
	5	7,07	17,81	16,88	6,74
	6	7,38	19,06	18,13	7,06
	7	7,54	19,98	19,02	7,23
	8	7,54	20,65	19,74	7,26
	9	7,40	21,12	20,15	7,14
	10	7,12	21,36	20,48	6,90
	11	6,65	21,39	20,60	6,47
	12	5,98	21,23	20,40	5,78
	14	3,48	20,27	19,61	3,33
	16	0,00	18,33	17,80	0,00

Escape route, 1Lux floor luminosity

Models	Height (m)				
OLY-1004/LT/WP 3h	2	3,38	8,21	7,85	3,22
OLY-1004/LF/WP 3h	2,5	3,65	9,13	8,62	3,47
	3	3,82	9,79	9,32	3,65
	3,5	3,92	10,29	9,78	3,74
	4	3,94	10,66	10,18	3,79
	5	3,78	11,10	10,61	3,65
	6	3,31	11,12	10,68	3,21
	7	2,32	10,74	10,37	2,22
	8	0,00	9,93	9,65	0,00

Open area, 0.5Lux floor luminosity

Models	Height (m)				
OLY-1004/LT/WP 3h	2	4,09	9,62	9,38	3,92
OLY-1004/LF/WP 3h	2,5	4,55	10,89	10,48	4,31
	3	4,88	11,96	11,41	4,66
	3,5	5,13	12,84	12,14	4,89
	4	5,31	13,54	12,91	5,09
	5	5,53	14,58	13,88	5,30
	6	5,54	15,26	14,60	5,34
	7	5,35	15,66	14,98	5,18
	8	4,94	15,76	15,19	4,82
	9	4,26	15,58	14,98	4,12
	10	3,10	15,11	14,62	3,00
	11	0,00	14,35	13,95	0,00

Escape route, 1Lux floor luminosity

Models	Height (m)				
OLY-1004/LT/WP 8h	2	2,02	5,43	5,18	1,94
OLY-1004/LF/WP 8h	2,5	1,95	5,67	5,42	1,89
	3	1,74	5,71	5,49	1,69
	3,5	1,31	5,55	5,36	1,25
	4	0,00	5,20	5,05	0,00

Open area, 0.5Lux floor luminosity

Models	Height (m)				
OLY-1004/LT/WP 8h	2	2,67	6,84	6,55	2,59
OLY-1004/LF/WP 8h	2,5	2,80	7,38	7,06	2,71
	3	2,82	7,74	7,44	2,74
	3,5	2,74	7,97	7,65	2,68
	4	2,55	8,04	7,79	2,52
	5	1,72	7,78	7,56	1,70
	6	0,00	6,92	6,79	0,00

## OLYMPUS LIGHT

Escape route, 1Lux floor luminosity

Models	Height (m)				
OLY-1004/SC/WP 1h	2	3,93	9,27	8,97	3,74
OLY-1004/SC/WP 1h	2,5	4,33	10,45	10,02	4,12
	3	4,62	11,44	10,85	4,39
	3,5	4,83	12,22	11,60	4,61
	4	4,98	12,83	12,20	4,76
	5	5,11	13,70	13,07	4,92
	6	5,03	14,26	13,60	4,84
	7	4,73	14,46	13,90	4,58
	8	4,14	14,40	13,82	4,00
	9	3,14	13,98	13,51	3,00
	10	0,38	13,28	12,87	0,42
	11	0,00	12,17	11,73	0,00

Open area, 0.5Lux floor luminosity

Models	Height (m)				
OLY-1004/SC/WP 1h	2	4,40	10,25	10,11	4,24
OLY-1004/SC/WP 1h	2,5	5,22	12,22	11,96	5,01
	3	5,71	13,55	13,08	5,42
	3,5	6,10	14,71	14,11	5,80
	4	6,40	15,73	14,98	6,10
	5	6,84	17,34	16,48	6,53
	6	7,11	18,49	17,58	6,80
	7	7,22	19,32	18,44	6,95
	8	7,18	19,93	19,06	6,91
	9	6,98	20,31	19,41	6,75
	10	6,62	20,45	19,69	6,43
	11	6,07	20,40	19,62	5,90
	12	5,26	20,11	19,37	5,06
	14	1,49	18,90	18,32	1,41
	16	0,00	15,52	14,94	0,00

Escape route, 1Lux floor luminosity

Models	Height (m)				
OLY-1004/LT/WP 3h	2	2,90	7,27	6,87	2,76
OLY-1004/LF/WP 3h	2,5	3,06	7,91	7,52	2,92
	3	3,13	8,35	7,96	3,00
	3,5	3,11	8,65	8,26	2,98
	4	3,00	8,82	8,44	2,89
	5	2,46	8,78	8,43	2,36
	6	0,94	8,24	7,98	0,87
	7	0,00	6,47	6,22	0,00

Open area, 0.5Lux floor luminosity

Models	Height (m)				
OLY-1004/LT/WP 3h	2	3,61	8,68	8,35	3,43
OLY-1004/LF/WP 3h	2,5	3,93	9,71	9,25	3,76
	3	4,15	10,51	9,99	3,98
	3,5	4,30	11,12	10,60	4,13
	4	4,39	11,59	11,05	4,22
	5	4,37	12,23	11,71	4,21
	6	4,09	12,50	12,03	3,99
	7	3,50	12,41	11,95	3,41
	8	2,36	11,97	11,59	2,30
	9	0,00	11,12	10,84	0,00

Escape route, 1Lux floor luminosity

Models	Height (m)				
OLY-1004/LT/WP 8h	2	1,50	4,41	4,22	1,44
OLY-1004/LF/WP 8h	2,5	1,23	4,39	4,21	1,18
	3	0,47	4,12	3,99	0,43
	3,5	0,00	3,23	3,11	0,00

Open area, 0.5Lux floor luminosity

Models	Height (m)				
OLY-1004/LT/WP 8h	2	2,15	5,74	5,52	2,11
OLY-1004/LF/WP 8h	2,5	2,14	6,06	5,85	2,10
	3	1,99	6,20	6,01	1,98
	3,5	1,69	6,15	5,97	1,68
	4	1,10	5,92	5,79	1,09
	5	0,00	4,23	4,19	0,00

Escape route, 1Lux floor luminosity

Models	Height (m)				
OLY-1004/CBS/24VDC	2	3,83	9,07	8,76	3,63
OLY-1004/CBS/24VDC/WP	2,5	4,20	10,20	9,76	4,01
	3	4,47	11,14	10,53	4,25
	3,5	4,65	11,85	11,29	4,45
	4	4,79	12,41	11,80	4,57
	5	4,87	13,20	12,61	4,68
	6	4,72	13,66	13,04	4,56
	7	4,33	13,77	13,26	4,21
	8	3,62	13,58	13,06	3,47
	9	2,27	13,06	12,62	2,16
	10	0,00	12,15	11,80	0,00

Open area, 0.5Lux floor luminosity

Models	Height (m)				
OLY-1004/CBS/24VDC	2	4,40	10,25	10,11	4,24
OLY-1004/CBS/24VDC/WP	2,5	5,10	11,97	11,66	4,88
	3	5,56	13,25	12,76	5,26
	3,5	5,91	14,36	13,74	5,64
	4	6,19	15,34	14,55	5,90
	5	6,59	16,81	16,04	6,30
	6	6,82	17,88	17,00	6,52
	7	6,88	18,62	17,80	6,63
	8	6,77	19,15	18,28	6,53
	9	6,51	19,42	18,62	6,31
	10	6,06	19,47	18,75	5,90
	11	5,38	19,30	18,54	5,20
	12	4,35	18,88	18,24	4,18
	13	2,57	18,25	17,69	2,47
	14	0,00	17,32	16,84	0,00

## OLYMPUS LIGHT

Escape route, 1Lux floor luminosity

Models	Height (m)				
OLY-1024/CBS/24VDC	2	7,81	18,29	7,80	3,10
OLY-1024/CBS/24VDC/WP	2,5	8,75	20,69	8,41	3,33
	3	9,46	22,78	8,95	3,52
	3,5	10,03	24,63	9,40	3,68
	4	10,44	26,12	9,78	3,86
	5	10,63	28,48	10,45	4,23
	6	4,94	29,96	11,20	4,46
	7	3,63	25,16	11,94	4,54
	8	2,23	22,01	12,44	4,34
	9	0,00	12,48	12,52	0,00

Open area, 0.5Lux floor luminosity

Models	Height (m)				
OLY-1024/CBS/24VDC	2	8,82	20,82	9,49	3,79
OLY-1024/CBS/24VDC/WP	2,5	10,00	23,53	10,59	4,20
	3	11,01	26,10	11,26	4,47
	3,5	11,90	28,44	11,85	4,70
	4	12,63	30,55	12,40	4,89
	5	13,79	34,20	13,34	5,22
	6	14,44	37,05	14,08	5,60
	7	14,39	39,25	14,74	5,97
	8	12,56	40,81	15,44	6,22
	9	6,24	39,71	16,24	6,38
	10	5,00	35,35	16,95	6,41
	11	3,70	32,63	17,47	6,26
	12	1,14	19,79	17,86	5,54
	13	0,00	16,96	14,41	0,00

## SPOT LIGHT

Escape route, 1Lux floor luminosity

Models	Height (m)				
GR-290/M	2	7,64	16,31	4,70	1,85
GR-290/M/WP	2,5	9,11	19,55	4,97	2,10
GR-290/M/WL	3	10,44	22,68	5,39	2,33
GR-290/M/WP/WL	3,5	11,47	25,58	5,90	2,54
GR-290/M/ADR	4	12,41	28,29	6,38	2,74
	5	13,71	32,65	7,23	3,03
	6	4,19	28,83	8,01	3,07
	7	2,17	27,64	8,56	2,63
	8	0	15,65	6,46	0

Open area, 0.5Lux floor luminosity

Models	Height (m)				
GR-291/M	2	4,76	10,58	9,63	4,35
GR-291/M/WP	2,5	5,51	12,41	11,25	5,08
GR-291/M/WL	3	6,17	14,06	12,85	5,69
GR-291/M/WP/WL	3,5	6,77	15,54	14,29	6,31
GR-291/M/ADR	4	7,24	16,88	15,54	6,86
	5	8,01	19,3	17,97	7,74
	6	7,99	21,01	20,09	8,29
	7	6,72	22,57	21,79	7,83
	8	4,12	22,13	22,28	4,38
	9	0	18,83	17,31	0

Escape route, 1Lux floor luminosity

Models	Height (m)				
GR-292/M	2	7,07	15,29	3,70	1,59
GR-292/M/WP	2,5	8,16	18,23	4,20	1,80
GR-292/M/WL	3	9,03	20,89	4,66	2,00
GR-292/M/WP/WL	3,5	9,66	22,94	5,08	2,14
GR-292/M/ADR	4	3,91	20,71	5,49	2,20
	5	1,42	19,44	6,07	1,82
	6	0,00	8,39	4,14	0,00

Open area, 0.5Lux floor luminosity

Models	Height (m)				
GR-293/M	2	4,19	9,52	8,71	3,88
GR-293/M/WP	2,5	4,80	11,03	10,17	4,49
GR-293/M/WL	3	5,24	12,34	11,39	5,02
GR-293/M/WP/WL	3,5	5,63	13,54	12,62	5,44
GR-293/M/ADR	4	5,77	14,49	13,73	5,75
	5	4,46	15,98	15,48	5,21
	6	1,71	15,25	14,71	1,90
	7	0,00	11,18	10,78	0,00

Escape route, 1Lux floor luminosity

Models	Height (m)				
GR-292/M/HL	2	7,71	16,52	4,89	1,90
GR-292/M/HL/WL	2,5	9,21	19,70	5,14	2,14
GR-292/M/HL/ADR	3	10,58	22,89	5,53	2,38
	3,5	11,69	25,86	6,03	2,60
	4	12,66	28,64	6,52	2,80
	5	14,10	33,27	7,39	3,13
	6	5,57	30,57	8,19	3,26
	7	2,83	29,53	8,81	2,97
	8	0	19,66	9,09	0

Open area, 0.5Lux floor luminosity

Models	Height (m)				
GR-293/M/HL	2	4,88	10,86	10,55	4,75
GR-293/M/HL/WL	2,5	5,67	12,76	12,28	5,53
GR-293/M/HL/ADR	3	6,39	14,48	14,00	6,20
	3,5	7,01	16,07	15,56	6,75
	4	7,54	17,53	16,95	7,18
	5	8,19	20,06	19,22	7,82
	6	8,39	21,99	20,83	8,08
	7	7,62	23,19	22,04	7,60
	8	5,82	23,8	22,8	6,64
	9	0	23,08	22,61	0



## SPOT LIGHT

Escape route, 1Lux floor luminosity

Models	Height (m)				
GR-270	2	7,13	15,39	3,77	1,61
	2,5	8,26	18,37	4,26	1,83
	3	9,20	21,08	4,73	2,03
	3,5	9,84	23,25	5,16	2,18
	4	4,53	22,59	5,57	2,27
	5	1,77	20,39	6,20	2,00
	6	0,00	10,21	4,46	0,00

Open area, 0.5Lux floor luminosity

Models	Height (m)				
GR-271	2	4,24	9,62	8,78	3,93
	2,5	4,86	11,16	10,28	4,54
	3	5,34	12,50	11,54	5,09
	3,5	5,73	13,72	12,76	5,54
	4	5,96	14,77	13,91	5,88
	5	5,05	16,31	15,74	5,82
	6	2,50	16,02	15,74	2,79
	7	0,00	12,01	11,54	0,00

Escape route, 1Lux floor luminosity

Models	Height (m)				
GR-272	2	6,82	14,95	3,52	1,52
	2,5	7,79	17,74	4,01	1,72
	3	8,48	20	4,44	1,88
	3,5	3,78	18,87	4,85	1,97
	4	2,06	18,02	5,19	1,89
	5	0	10,32	4,22	0

Open area, 0.5Lux floor luminosity

Models	Height (m)				
GR-273	2	4,01	9,16	8,43	3,72
	2,5	4,54	10,56	9,76	4,31
	3	4,93	11,8	10,97	4,77
	3,5	5,17	12,84	12,13	5,11
	4	4,83	13,59	13,08	5,2
	5	2,72	14,06	14,12	2,82
	6	0	10,61	10,11	0

Escape route, 1Lux floor luminosity

Models	Height (m)				
GR-290	2	7,57	16,08	4,5	1,8
GR-290/ADR	2,5	9	19,37	4,8	2,05
GR-280/24VDC	3	10,23	22,43	5,28	2,28
GR-280/24V/ADR	3,5	11,23	25,26	5,78	2,49
GR-280	4	12,09	27,92	6,23	2,67
	5	13,05	31,96	7,08	2,93
	6	3,09	27,03	7,79	2,83
	7	0,91	25,75	8,22	1,51
	8	0,00	11,52	5,60	0,00

Open area, 0.5Lux floor luminosity

Models	Height (m)				
GR-291	2	4,67	10,42	9,49	4,29
GR-291/ADR	2,5	5,4	12,21	11,1	4,98
GR-281/24VDC	3	6,04	13,81	12,65	5,59
GR-281/24V/ADR	3,5	6,62	15,23	14,02	6,19
GR-281	4	7,02	16,52	15,23	6,71
	5	7,69	18,87	17,64	7,52
	6	7,25	20,41	19,63	7,86
	7	5,41	21,51	21,18	6,10
	8	2,69	20,54	19,79	3,00
	9	0,00	15,92	15,17	0,00

Escape route, 1Lux floor luminosity

Models	Height (m)				
GR-292	2	7,13	15,39	3,77	1,61
GR-292/ADR	2,5	8,26	18,37	4,26	1,83
	3	9,2	21,08	4,73	2,03
	3,5	9,84	23,25	5,16	2,18
	4	4,53	22,59	5,57	2,27
	5	1,77	20,39	6,2	2
	6	0	10,21	4,46	0

Open area, 0.5Lux floor luminosity

Models	Height (m)				
GR-293	2	4,3	9,71	9,46	4,21
GR-293/ADR	2,5	4,92	11,29	11	4,76
	3	5,39	12,7	12,34	5,15
	3,5	5,67	13,92	13,4	5,45
	4	5,84	14,97	14,23	5,63
	5	5,05	16,19	15,48	5,14
	6	2,33	16,38	15,85	3,01
	7	0,00	12,23	11,48	0,00

Escape route, 1Lux floor luminosity





Models	Height (m)				
GR-220/M/DUO	2	7,28	16,10	6,74	2,62
	2,5	8,36	18,91	7,19	2,69
	3	9,18	21,46	7,52	2,76
	3,5	9,93	23,53	7,62	2,87
	4	10,67	25,20	7,70	3,02
	5	11,99	28,23	8,16	3,24
	6	12,39	31,22	8,76	3,32
	7	2,78	27,03	9,14	2,98
	8	0,00	24,65	9,38	0,00

Open area, 0.5Lux floor luminosity





Models	Height (m)				
GR-220/M/DUO	2	4,84	10,98	9,7	4,32
	2,5	5,51	12,71	11,18	5,04
	3	6,12	14,19	12,76	5,64
	3,5	6,72	15,51	14,18	6,19
	4	7,24	16,76	15,4	6,66
	5	8,01	19,15	17,62	7,46
	6	8,25	21,13	19,42	8,02
	7	7,07	22,61	21,01	7,86
	8	4,5	22,79	22,34	5,21
	9	0	20,33	18,53	0

## SPOT LIGHT





Escape route, 1Lux floor luminosity

Models	Height (m)				
GR-221/M/DUO	2	6,30	14,57	5,24	1,92
	2,5	7,05	16,72	5,39	2,04
	3	7,80	18,36	5,52	2,19
	3,5	8,45	19,86	5,75	2,28
	4	8,82	21,34	6,05	2,34
	5	1,87	18,89	6,48	2,08
6	0,00	16,83	4,86	0,00	





Open area, 0.5Lux floor luminosity

Models	Height (m)				
GR-221/M/DUO	2	4,18	9,69	8,65	3,85
	2,5	4,77	11,03	10,09	4,4
	3	5,26	12,25	11,28	4,85
	3,5	5,63	13,44	12,38	5,25
	4	5,83	14,48	13,32	5,56
	5	4,8	16,03	14,92	5,44
	6	2,27	15,65	15,48	2,11
7	0	11,59	10,72	0	





Open area, 1Lux floor luminosity

Models	Height (m)				
GR-298/60L	2	3,92	9,59	9,28	3,79
GR-298/60L/WP	2,5	4,90	11,99	11,61	4,73
	3	5,46	13,41	13,03	5,31
	3,5	5,82	14,28	13,88	5,67
	4	6,17	15,13	14,67	5,98
	5	6,77	16,59	16,1	6,54
	6	7,24	17,93	17,34	6,99
	7	7,6	19,11	18,44	7,34
	8	7,85	20,1	19,37	7,56
	9	7,98	20,92	20,17	7,68
	10	8	21,59	20,83	7,71
	11	7,86	22,10	21,28	7,59
	12	7,60	22,45	21,59	7,34
	13	7,15	22,64	21,77	6,91
	14	6,48	22,66	21,82	6,28
	15	5,48	22,47	21,65	5,28
	16	3,87	22,09	21,31	3,83
17	0,00	21,51	20,74	0,00	





Open area, 0.5Lux floor luminosity

Models	Height (m)				
GR-298/30L	2	3,72	9,15	8,93	3,64
	2,5	4,09	10,04	9,79	3,99
	3	4,42	10,85	10,56	4,3
	3,5	4,72	11,58	11,26	4,58
	4	4,96	12,26	11,89	4,8
	5	5,33	13,45	13	5,16
	6	5,54	14,38	13,88	5,34
	7	5,58	15,08	14,57	5,39
	8	5,42	15,56	14,99	5,24
	9	5,03	15,8	15,21	4,87
	10	4,33	15,8	15,23	4,2
	11	3,05	15,51	14,98	3,01
12	0,00	14,94	14,41	0,00	

Open area, 1Lux floor luminosity

Models	Height (m)				
GR-296/60L/CBS/230	2	3,92	9,59	9,28	3,79
	2,5	4,90	11,99	11,61	4,73
	3	5,67	13,90	13,51	5,51
	3,5	6,03	14,83	14,4	5,88
	4	6,4	15,68	15,21	6,21
	5	7,03	17,19	16,71	6,8
	6	7,54	18,61	17,99	7,28
	7	7,95	19,84	19,16	7,67
	8	8,24	20,92	20,16	7,95
	9	8,44	21,82	21,03	8,12
	10	8,52	22,58	21,77	8,2
	11	8,49	23,19	22,36	8,18
	12	8,31	23,66	22,76	8,03
	13	8,01	23,96	23,03	7,73
	14	7,52	24,12	23,19	7,26
	15	6,82	24,12	23,22	6,60
	16	5,81	23,92	23,04	5,59
	17	4,19	23,53	22,70	4,15
18	0,00	22,97	22,15	0,00	

Open area, 0.5Lux floor luminosity

Models	Height (m)				
GR-296/30L/CBS/230	2	3,89	9,55	9,28	3,79
	2,5	4,27	10,49	10,22	4,17
	3	4,62	11,34	11,02	4,49
	3,5	4,93	12,07	11,76	4,79
	4	5,2	12,8	12,43	5,04
	5	5,62	14,06	13,6	5,44
	6	5,89	15,09	14,56	5,69
	7	6,01	15,9	15,35	5,79
	8	5,96	16,49	15,91	5,76
	9	5,72	16,88	16,24	5,53
	10	5,25	17,05	16,41	5,08
	11	4,43	16,98	16,36	4,30
	12	2,98	16,63	16,06	2,95
13	0,00	16,03	15,46	0,00	

## SPOT LIGHT

Escape route, 1Lux floor luminosity

Models	Height (m)				
Kit-77-84	2	2,81	6,37	5,92	2,58
	2,5	3,21	7,36	6,74	2,96
	3	3,52	8,26	7,59	3,28
	3,5	3,73	9,04	8,34	3,51
	4	3,86	9,69	8,99	3,65
	5	3,74	10,6	9,97	3,63
	6	3,23	11	10,45	3,12
	7	2,41	10,63	10,31	2,25
8	0	9,74	9,48	0	

Open area, 0.5Lux floor luminosity

Models	Height (m)				
Kit-77-84	2	3,15	7,66	6,9	2,92
	2,5	3,64	8,46	7,84	3,31
	3	4,09	9,33	8,59	3,73
	3,5	4,49	10,29	9,39	4,11
	4	4,81	11,21	10,24	4,45
	5	5,27	12,82	11,78	4,94
	6	5,47	14,04	13,04	5,19
	7	5,29	14,9	13,98	5,11
	8	4,85	15,43	14,56	4,67
	9	4,21	15,43	14,78	3,96
	10	3,28	14,94	14,46	2,96
	11	0,09	14,09	13,64	0,21
12	0	12,92	12,4	0	

## TETRAGONO

Escape route, 1Lux floor luminosity

Models	Height (m)				
GR-490	2	6,51	14,18	5,69	2,17
GR-490/WP	2,5	7,63	16,80	6,01	2,21
GR-490/ADR	3	8,59	19,23	6,18	2,28
GR-490/WL	3,5	9,48	21,43	6,26	2,40
GR-490/WL/WP	4	10,38	23,39	6,33	2,54
	5	11,76	27,02	6,82	2,69
	6	1,91	21,86	7,34	2,50
	7	0	20,91	5,79	0

Open area, 0.5Lux floor luminosity

Models	Height (m)				
GR-491	2	4,82	10,75	9,93	4,36
GR-491/WP	2,5	5,55	12,57	11,36	5,07
GR-491/ADR	3	6,20	14,17	12,86	5,64
GR-491/WL	3,5	6,66	15,62	14,25	6,12
GR-491/WL/WP	4	7,05	16,96	15,43	6,57
	5	7,53	18,96	17,4	7,24
	6	6,91	20,45	19,15	7,33
	7	4,89	21,17	20,44	5,46
	8	0,14	19,90	19,23	1,91
9	0	15,89	14,75	0	

Escape route, 1Lux floor luminosity

Models	Height (m)				
GR-492	2	5,84	13,03	4,35	1,58
GR-492/WP	2,5	6,75	15,26	4,42	1,70
GR-492/ADR	3	7,62	17,18	4,56	1,83
GR-492/WL	3,5	8,28	18,97	4,81	1,90
GR-492/WL/WP	4	1,94	16,11	5,08	1,87
	5	0,00	14,59	3,94	0,00

Open area, 0.5Lux floor luminosity

Models	Height (m)				
GR-493	2	4,23	9,64	8,73	3,85
GR-493/WP	2,5	4,71	11,11	10,14	4,35
GR-493/ADR	3	5,08	12,41	11,29	4,78
GR-493/WL	3,5	5,30	13,32	12,24	5,09
GR-493/WL/WP	4	5,14	14,10	13,14	5,19
	5	3,37	14,93	14,48	3,31
	6	0,00	13,01	11,85	0,00

Escape route, 1Lux floor luminosity

Models	Height (m)				
GR-470	2	5,88	13,08	4,42	1,60
GR-470/WP	2,5	6,79	15,35	4,50	1,72
	3	7,67	17,29	4,61	1,85
	3,5	8,36	19,08	4,86	1,93
	4	2,10	17,06	5,14	1,92
	5	0,00	15,14	4,37	0,00

Open area, 0.5Lux floor luminosity

Models	Height (m)				
GR-471	2	4,26	9,71	8,78	3,88
GR-471/WP	2,5	4,76	11,19	10,21	4,38
	3	5,14	12,50	11,37	4,83
	3,5	5,39	13,46	12,34	5,16
	4	5,28	14,25	13,25	5,28
	5	3,58	15,23	14,66	3,80
	6	2,08	14,62	14,43	2,28
	7	0,00	13,69	12,81	0,00

## TETRAGONO LIGHT

Escape route, 1Lux floor luminosity

Models	Height (m)				
GR-472	2	5,30	11,97	3,32	1,32
GR-472/WP	2,5	6,11	13,81	3,56	1,42
	3	1,51	12,32	3,83	1,42
	3,5	0,00	11,38	4,02	0,00

Open area, 0.5Lux floor luminosity

Models	Height (m)				
GR-473	2	3,63	8,70	7,93	3,39
GR-473/WP	2,5	3,96	9,81	8,98	3,78
	3	3,89	10,59	9,89	3,87
	3,5	3,01	11,22	10,64	3,23
	4	1,77	10,97	10,79	1,83
	5	0,00	7,92	7,49	0,00

Escape route, 1Lux floor luminosity

Models	Height (m)				
GR-480	2	6,48	14,12	5,61	2,14
GR-480/WP	2,5	7,58	16,73	5,92	2,16
	3	8,53	19,13	6,08	2,25
	3,5	9,43	21,3	6,13	2,37
	4	10,31	23,25	6,24	2,51
	5	6,3	26,86	6,74	2,65
	6	1,66	21,32	7,25	2,37
	7	0	20,08	5,34	0

Escape route, 1Lux floor luminosity

Models	Height (m)				
GR-480	2	6,48	14,12	5,61	2,14
GR-480/WP	2,5	7,58	16,73	5,92	2,16
	3	8,53	19,13	6,08	2,25
	3,5	9,43	21,3	6,13	2,37
	4	10,31	23,25	6,24	2,51
	5	6,3	26,86	6,74	2,65
	6	1,66	21,32	7,25	2,37
	7	0	20,08	5,34	0

## CONVERTERS

Escape route, 1Lux floor luminosity

Models	Height (m)				
PTD-1400X	2	4,08	9,83	9,52	3,98
PTD-1400X3	2,5	4,49	10,90	10,62	4,38
	3	4,80	11,84	11,55	4,69
	3,5	5,04	12,66	12,34	4,95
	4	5,21	13,33	13,00	5,15
	5	5,38	14,32	14,05	5,39
	6	5,39	14,92	14,81	5,39
	7	5,20	15,22	15,24	5,24
	8	4,74	15,28	15,35	4,84
	9	3,99	15,16	15,10	4,25
	10	2,82	14,65	14,79	3,09
	11	0,00	13,77	14,04	0,00

Open area, 0.5Lux floor luminosity

Models	Height (m)				
PTD-1400X	2	4,44	10,63	10,24	4,32
PTD-1400X3	2,5	5,45	13,08	12,60	5,28
	3	5,91	14,28	13,83	5,74
	3,5	6,31	15,34	14,91	6,14
	4	6,64	16,31	15,87	6,47
	5	7,12	17,95	17,49	6,99
	6	7,42	19,19	18,75	7,37
	7	7,57	20,13	19,76	7,59
	8	7,61	20,79	20,57	7,64
	9	7,54	21,25	21,18	7,52
	10	7,30	21,48	21,53	7,36
	11	6,88	21,56	21,69	6,96
	12	6,26	21,50	21,53	6,41
	14	4,14	20,78	20,93	4,51
	16	0,00	18,97	19,25	0,00

Escape route, 1Lux floor luminosity





Models	Height (m)				
GTD-1400X	2	4,23	10,17	9,83	4,13
GTD-1400X3	2,5	4,67	11,30	10,99	4,55
	3	5,02	12,28	11,98	4,90
	3,5	5,28	13,15	12,83	5,18
	4	5,49	13,91	13,55	5,40
	5	5,72	15,00	14,70	5,71
	6	5,77	15,74	15,55	5,80
	7	5,69	16,17	16,13	5,68
	8	5,36	16,32	16,41	5,46
	9	4,78	16,31	16,33	4,92
	10	3,82	16,04	16,05	4,14
	11	2,43	15,46	15,66	2,89
	12	0,00	14,45	14,74	0,00

Open area, 0.5Lux floor luminosity





Models	Height (m)				
GTD-1400X	2	4,44	10,63	10,24	4,32
GTD-1400X3	2,5	5,54	13,28	12,79	5,39
	3	6,14	14,79	14,30	5,96
	3,5	6,56	15,91	15,44	6,38
	4	6,93	16,92	16,45	6,75
	5	7,47	18,67	18,18	7,32
	6	7,83	20,06	19,56	7,74
	7	8,04	21,10	20,67	8,03
	8	8,13	21,90	21,57	8,17
	9	8,12	22,46	22,30	8,13
	10	7,99	22,83	22,80	8,00
	11	7,71	23,01	23,10	7,80
	12	7,22	23,05	23,17	7,31
	14	5,58	22,70	22,70	5,98
	16	2,28	21,46	21,74	2,96
	18	0,00	19,12	19,60	0,00

## CONVERTERS





Escape route, 1Lux floor luminosity

Models	Height (m)				
PTD-1700X	2	4,71	11,85	9,65	4,06
	2,5	5,75	14,50	11,84	4,97
	3	6,12	15,43	12,97	5,42
	3,5	6,47	16,23	14,00	5,77
	4	6,77	16,94	14,92	6,05
	5	7,25	18,36	16,40	6,49
	6	7,54	19,52	17,47	6,79
	7	7,71	20,46	18,32	6,96
	8	7,75	21,10	18,96	7,08
	9	7,60	21,52	19,42	7,02
	10	7,36	21,82	19,72	6,78
	11	6,98	21,97	19,98	6,41
	12	6,39	21,76	20,08	5,97
	14	4,22	20,91	19,26	4,33
16	0,00	19,32	17,78	0,00	





Open area, 0.5Lux floor luminosity

Models	Height (m)				
PTD-1700X	2	4,44	10,63	10,24	4,32
	2,5	5,54	13,28	12,79	5,39
	3	6,14	14,79	14,30	5,96
	3,5	6,56	15,91	15,44	6,38
	4	6,93	16,92	16,45	6,75
	5	7,47	18,67	18,18	7,32
	6	7,83	20,06	19,56	7,74
	7	8,04	21,10	20,67	8,03
	8	8,13	21,90	21,57	8,17
	9	8,12	22,46	22,30	8,13
	10	7,99	22,83	22,80	8,00
	11	7,71	23,01	23,10	7,80
	12	7,22	23,05	23,17	7,31
	14	5,58	22,70	22,70	5,98
16	2,28	21,46	21,74	2,96	
18	0,00	19,12	19,60	0,00	





Escape route, 1Lux floor luminosity

Models	Height (m)				
GTD-1700X	2	4,71	11,85	9,65	4,06
	2,5	5,87	14,78	12,01	5,05
	3	6,25	15,76	13,18	5,51
	3,5	6,60	16,59	14,23	5,89
	4	6,91	17,30	15,18	6,18
	5	7,42	18,76	16,74	6,64
	6	7,74	19,95	17,85	6,96
	7	7,93	20,94	18,74	7,15
	8	8,02	21,65	19,43	7,29
	9	7,91	22,12	19,94	7,30
	10	7,69	22,46	20,27	7,09
	11	7,36	22,66	20,56	6,77
	12	6,88	22,58	20,72	6,35
	14	4,95	21,84	20,14	5,15
16	0,00	20,46	18,79	0,00	





Open area, 0.5Lux floor luminosity

Models	Height (m)				
GTD-1700X	2	4,71	11,85	9,65	4,06
	2,5	5,87	14,78	12,01	5,05
	3	7,05	17,74	14,42	6,06
	3,5	8,22	20,70	16,82	7,07
	4	8,65	21,79	18,11	7,59
	5	9,38	23,52	20,23	8,35
	6	9,97	25,00	22,06	8,90
	7	10,44	26,43	23,55	9,36
	8	10,80	27,66	24,72	9,71
	9	11,04	28,74	25,70	9,97
	10	11,21	29,66	26,57	10,13
	11	11,31	30,39	27,29	10,27
	12	11,28	30,94	27,86	10,34
	14	10,92	31,70	28,63	10,03
16	10,23	32,06	29,16	9,39	
18	8,95	31,64	29,15	8,41	
20	6,75	30,79	28,31	6,97	
22	2,18	29,47	27,07	2,67	
24	0,00	27,48	25,39	0,00	

Escape route, 1Lux floor luminosity





Models	Height (m)				
PTD-2700X	2	4,60	11,40	9,30	3,89
PTD-2700X3	2,5	5,75	14,24	11,60	4,86
PTD-2700XP	3	6,16	15,31	12,73	5,27
PTD-2700XP3	3,5	6,51	16,23	13,68	5,65
	4	6,80	17,03	14,50	5,97
	5	7,21	18,47	16,02	6,45
	6	7,50	19,57	17,29	6,79
	7	7,67	20,36	18,20	7,02
	8	7,73	20,99	18,89	7,08
	9	7,69	21,43	19,48	7,03
	10	7,35	21,72	19,89	6,87
	11	6,92	21,85	20,03	6,57
	12	6,31	21,85	20,02	6,13
	14	3,97	20,93	19,51	4,46
	16	0,00	19,13	18,24	0,00

Open area, 0.5Lux floor luminosity





Models	Height (m)				
PTD-2700X	2	4,60	11,40	9,30	3,89
PTD-2700X3	2,5	5,75	14,24	11,60	4,86
PTD-2700XP	3	6,90	17,08	13,91	5,82
PTD-2700XP3	3,5	8,04	19,92	16,22	6,79
	4	8,51	21,14	17,46	7,25
	5	9,23	23,02	19,41	8,01
	6	9,78	24,63	21,03	8,64
	7	10,18	26,04	22,55	9,10
	8	10,49	27,22	23,88	9,44
	9	10,71	28,12	24,97	9,74
	10	10,86	28,86	25,82	9,94
	11	10,92	29,50	26,51	10,01
	12	10,92	30,02	27,16	10,01
	14	10,46	30,69	28,10	9,75
	16	9,56	30,93	28,35	9,11
18	8,02	30,78	28,15	8,04	
20	5,29	29,42	27,50	6,11	
22	0,00	27,68	26,28	0,00	

## CONVERTERS

Escape route, 1Lux floor luminosity

Models	Height (m)				
GTD-2700X	2	4,60	11,40	9,30	3,89
GTD-2700X3	2,5	5,75	14,24	11,60	4,86
GTD-2700XP	3	6,28	15,61	12,94	5,37
GTD-2700XP3	3,5	6,65	16,56	13,92	5,75
	4	6,96	17,38	14,76	6,08
	5	7,39	18,87	16,31	6,60
	6	7,70	20,03	17,63	6,95
	7	7,89	20,87	18,61	7,21
	8	7,97	21,53	19,34	7,31
	9	7,97	22,02	19,97	7,29
	10	7,73	22,36	20,43	7,17
	11	7,30	22,54	20,66	6,91
	12	6,80	22,59	20,70	6,52
	14	4,79	21,99	20,33	5,04
	16	0,00	20,27	19,24	2,70
	18	0,00	16,00	17,30	0,00

Open area, 0.5Lux floor luminosity

Models	Height (m)				
GTD-2700X	2	4,60	11,40	9,30	3,89
GTD-2700X3	2,5	5,75	14,24	11,60	4,86
GTD-2700XP	3	6,90	17,08	13,91	5,82
GTD-2700XP3	3,5	8,04	19,92	16,22	6,79
	4	8,69	21,56	17,74	7,38
	5	9,43	23,49	19,75	8,15
	6	10,01	25,13	21,43	8,81
	7	10,43	26,59	22,96	9,30
	8	10,76	27,84	24,34	9,67
	9	11,01	28,79	25,51	9,98
	10	11,18	29,58	26,40	10,21
	11	11,27	30,26	27,15	10,33
	12	11,29	30,82	27,80	10,35
	14	10,99	31,58	28,84	10,16
	16	10,13	31,91	29,26	9,62
	18	8,84	31,88	29,18	8,71
	20	6,50	30,94	28,68	6,95
	22	1,86	29,23	27,64	4,73
	24	0,00	27,18	25,74	0,00



# INDEX



# INDEX ACCESSORIES

Type	Page
A-1015	15
A-1017	27
A-1018/PL	43
A-1018/PL/ST	45
A-1020/PL	43
A-1020/PL/ST	45
A-1130	45
A-1131	45
A-1132	45
A-1133	45
A-1134	45
A-1135	59
A-1136	59
A-1200	120
A-1202	120
A-1900	25
A-2000/B	13
A-2000/W	13
A-2130	37
A-2131	37
A-2132	37
A-2133	37
A-2136	37
A-2510/PL	49
A-2510/PL/ST/M	49
A-2520/PL	51
A-2520/PL/SP	51
A-3008	14
A-3018	19
A-9000	27
A-9100	25
A-9100/ST	25
GR-6079	85
GR-8210/MONIT	120
GR-8510	120
GR-8530	85
GR-8610	128
GR-9510	138
IRT200A	13
SP-1100/RLDUB	33
SP-1116/RLDUB	19
SP-1008/RLDUB	14

# INDEX BATTERIES

Type	Page
A-1017	27
A-9000	27
A-918/HT	33
A-926	13
A-931/HT	13
A-938/HT	43
A-947	77
A-965/HT	37
A-986	69
A-988	69
B-925/HT	33
B-936/HT60SC	19
B-941/HT	19
B-949/HT	19
B-954/HT	59
B-972/HT	13
B-973/HT	15
B-974/HT	21
C-930/HT	59
GR-71	80
GR-72	80
GR-81	80
GR-82	80

# INDEX LUMINAIRES

Type	Page
CLD-30	47
CLD-30/MST	47
DLD-28/CBS/w	146
DLD-34/CBS/w	146
DLD-44/CBS/w	146
GR/316/6P/A	19
GR-1004	80
GR-1004-A/61	80
GR-1004-B/62	80
GR-1004-C/71	80
GR-1004-E/81	80
GR-1004-F/82	80
GR-108/12L/90	15
GR-109/12L/180	15
GR-1107/100V	81
GR-1107/100V/B-941/HT	81
GR-1107/100V/B-973/HT	81
GR-1107/100V/B973/HT/3H	81
GR-1107/60V	81
GR-1107/60V/B-941/HT	81
GR-1107/60V/B-973/HT	81
GR-119	78
GR-119/6L/42V/KL	15
GR-1310/12L/180	21
GR-1310/12L/90	21
GR-1310/15L	21
GR-1310/30L	21
GR-1310/4P	21
GR-1310/6P	21
GR-1312/15L	21
GR-1312/30L	21
GR-1312/4P	21
GR-1312/6P	21
GR-1315/15L	21
GR-1315/30L	21
GR-1315/4P	21
GR-1315/6P	21
GR-1316/15L	21
GR-1316/30L	21
GR-1316/4P	21
GR-1316/6P	21
GR-1324/15L	141
GR-1324/15L/24V DC	123
GR-1324/30L	141
GR-1324/30L/24V DC	123
GR-1325/15L/24V/ADR	131
GR-1325/30L/24V/ADR	131
GR-1350/LL/WL HIGH LUMINOCITY	104
GR-1351/HL/WL LOW LUMINOCITY	104
GR-151-3/L	15
GR-1926/15L	142
GR-1926/15L/24V DC	124
GR-1926/15L/24V/ADR	129
GR-1926/30L	142
GR-1926/30L/24V DV	124
GR-1926/30L/24V/ADR	129
GR-1926/4P	142
GR-1926/6P	142
GR-1935/15L	25
GR-1935/30L	25
GR-1936/15L	25
GR-1936/30L	25
GR-1938/15L	25
GR-1938/15L/ADR	87
GR-1938/30L	25
GR-1938/30L/ADR	87
GR-1938/4P	25
GR-1938/6P	25
GR-1939/15L	25
GR-1939/15L/ADR	87
GR-1939/30L	25
GR-1939/30L/ADR	87
GR-1939/4P	25
GR-1939/6P	25
GR-1950/LL/WL LOW LUMINOCITY	106
GR-1951/HL/WL HIGH LUMINOCITY	106

Type	Page
GR-200/CBS/WP	154
GR-2000/CBS	142
GR-220/DUO/M	75
GR-221/DUO/M	75
GR-266/M	74
GR-267/M	74
GR-270	74
GR-271	74
GR-272	74
GR-273	74
GR-280	150
GR-280/24V DC	125
GR-280/24V/ADR	136
GR-281	150
GR-281/24V DC	125
GR-281/24V/ADR	136
GR-288	154
GR-290	74
GR-290/ADR	94
GR-290/ADR/WP	94
GR-290/M/WL	114
GR-290/WP	74
GR-290/WP/M	74
GR-290/WP/M/WL	114
GR-290M	74
GR-291	74
GR-291/ADR	94
GR-291/ADR/WP	94
GR-291/M	74
GR-291/M/WL	114
GR-291/WP	74
GR-291/WP/M	74
GR-291/WP/M/WL	114
GR-292	74
GR-292/ADR	94
GR-292/ADR/WP	94
GR-292/M	74
GR-292/M/HL	74
GR-292/M/HL/ADR	94
GR-292/M/HL/WL	114
GR-292/M/WL	114
GR-292/WP	74
GR-292/WP/M	74
GR-292/WP/M/WL	114
GR-293	74
GR-293/ADR	94
GR-293/ADR/WP	94
GR-293/M	74
GR-293/M/HL	74
GR-293/M/HL/ADR	94
GR-293/M/HL/WL	114
GR-293/M/WL	114
GR-293/WP	74
GR-293/WP/M	74
GR-293/WP/M/WL	114
GR-296/30L/CBS/230V	150
GR-296/60L/CBS/230V	150
GR-297/60L/180	74
GR-298/30L/180	74
GR-298/60L/90	74
GR-298/60L/90/WP	74
GR-308/15L/A	19
GR-309/15L/A	19
GR-310/12L/180/A	19
GR-310/12L/90/A	19
GR-310/15L/A	19
GR-310/30L/A	19
GR-312/15L/A	19
GR-312/30L/A	19
GR-315/15L/A	19
GR-315/30L/A	19
GR-315/4P/A	19
GR-315/6P/A	19
GR-316/15L/A	19
GR-316/30L/A	19
GR-316/4P/A	19

# INDEX LUMINAIRES

Type	Page
GR-324/15L/24V DC/A	122
GR-324/15L/24V/ADR/A	130
GR-324/15L/A	140
GR-324/30L/24V DC/A	122
GR-324/30L/24V/ADR/A	130
GR-324/30L/A	140
GR-324/4P/A	140
GR-325/6P/24V DC/A	122
GR-325/6P/A	140
GR-37/180/WP/ADR	97
GR-370/LL/WL LOW LUMINOCITY	104
GR-371/HL/WL HIGH LUMINOCITY	104
GR-415/1PL	61
GR-424/1PL	152
GR-470	76
GR-470/WP	76
GR-471	76
GR-471/WP	76
GR-472	76
GR-472/WP	76
GR-473	76
GR-473/WP	76
GR-480/CBS	151
GR-480/CBS/WP	151
GR-481/CBS	151
GR-481/CBS/WP	151
GR-490	76
GR-490/ADR	95
GR-490/WL	115
GR-490/WP	76
GR-490/WP/ADR	95
GR-490/WP/WL	115
GR-491	76
GR-491/ADR	95
GR-491/WL	115
GR-491/WP	76
GR-491/WP/ADR	95
GR-491/WP/WL	115
GR-492	76
GR-492/ADR	95
GR-492/ADR	95
GR-492/WL	115
GR-492/WP	76
GR-492/WP/ADR	95
GR-492/WP/WL	115
GR-493	76
GR-493/WL	115
GR-493/WP	76
GR-493/WP/ADR	95
GR-493/WP/WL	115
GR-537/L/316Ti/CBS	152
GR-575/L/WP	153
GR-576/L/15/WP	153
GR-576/L/15/WP/O	153
GR-576/L/18/WP	153
GR-576/L/18/WP/O	153
GR-577/L/15/ST/WP	65
GR-577/L/18/ST/WP	65
GR-578/L/15/ST/WP	65
GR-578/L/18/ST/WP	65
GR-579/L/180/WP	65
GR-579/L/90/WP	65
GR-60	78
GR-6079	85
GR-6500	85
GR-6600/WL/V2	102
GR-6601/WL/V2	102
GR-750/CBS/24V/ADR/HP/LL	134
GR-750/CBS/HP/LL LOW LUMINOCITY	148
GR-750/ST/HP/LL	35
GR-750/ST/HP/LL/ADR LOW LUMINOCITY	92
GR-750/ST/HP/LL/WL LOW LUMINOCITY	108
GR-750/ST/LP/LL/WL LOW LUMINOCITY	108
GR-751/CBS/24V/ADR/LP/LL	134
GR-751/CBS/LP/LL LOW LUMINOCITY	148
GR-751/ST/LP/LL	35

Type	Page
GR-751/ST/LP/LL/ADR LOW LUMINOCITY	92
GR-752/CBS/24V/ADR/HP/HL	134
GR-752/CBS/HP/HL LOW LUMINOCITY	148
GR-752/ST/HP/HL	35
GR-752/ST/HP/HL/ADR HIGH LUMINOCITY	92
GR-752/ST/HP/HL/WL HIGH LUMINOCITY	108
GR-753/CBS/24V/ADR/LP/HL	134
GR-753/CBS/LP/HL HIGH LUMINOCITY	148
GR-753/ST/LP/HL	35
GR-753/ST/LP/HL/ADR HIGH LUMINOCITY	92
GR-753/ST/LP/HL/WL HIGH LUMINOCITY	108
GR-7603/V2 Ethernet Wifi Gateway	103
GR-7604/V2 Network Extender	103
GR-7605/V2 Rssi tester/USB gateway	103
GR-7606/V2 In/Out Wireless Unit	102
GR-7607/V2 USB Gateway	102
GR-7610/V2	100
GR-8/leds	14
GR-80/W	77
GR-80/W/SL	77
GR-80/WW	77
GR-82/230V	77
GR-82/230V/SQ	77
GR-82/WP/230V	77
GR-82/WP/230V/SQ	77
GR-83	77
GR-8500/300/12	120
GR-8500/300/16	120
GR-8500/300/4	120
GR-8500/300/8	120
GR-8500/600/16	120
GR-8500/600/8	120
GR-8500/PS	120
GR-8500/PS	128
GR-8500/PSC	120
GR-8500/PSC	128
GR-8500/PSC	138
GR-8530	85
GR-8600/300/4	128
GR-8600/300/8	128
GR-8600/600/8	128
GR-900/30L/SC	29
GR-926/15L	142
GR-926/15L/24V DC	124
GR-926/30L	142
GR-926/30L/24V DC	124
GR-926/4P	142
GR-926/6P	142
GR-935/15L	27
GR-935/30L	27
GR-935/4P	27
GR-935/6P	27
GR-936/15L	27
GR-936/30L	27
GR-936/4P	27
GR-936/6P	27
GR-940/15L	27
GR-941/15L	27
GR-9500/300/4	138
GR-9500/300/8	138
GR-9500/600/8	138
GR9-9/leds	14
GRL-21	69
GRL-21/H/180	69
GRL-21/H/180/WP	69
GRL-21/H/90	69
GRL-21/H/90/WP	69
GRL-22	69
GRL-29	69
GRL-29/ADR	97
GRL-29/WL	117
GRL-29/WP	69
GRL-29/WP/ADR	97
GRL-29/WP/WL	117
GRL-37/180	69
GRL-37/180/ADR	97

# INDEX LUMINAIRES

Type	Page
GRL-37/180/WL	117
GRL-37/180/WP	69
GRL-37/180/WP/WL	117
GRL-37/90	69
GRL-37/90/ADR	97
GRL-37/90/WL	117
GRL-37/90/WP	69
GRL-37/90/WP/ADR	97
GRL-37/90/WP/WL	117
GRL-38/90/M	69
GRL-822/EM	57
GRL-824/EM	57
GRL-832/EM	57
GRL-834/EM	57
GRL-842/EM	57
GRL-844/EM	57
GRL-860/EM	146
GRL-870/EM	146
GRL-880/EM	146
GTD1400X	71
GTD1400X3	71
GTD1700XP	71
GTD2700X	71
GTD2700X3	71
GTD2700XP	71
GTD2700XP3	71
KIT-77/84	75
KLD-22	51
KLD-22/ST	51
KLD-22/ST/ADR	90
KLD-22/ST/WL	110
KLD-30	51
KLD-30/CBS/24V/ADR	132
KLD-30/ST	51
KLD-30/ST/ADR	90
KLD-30/ST/WL	110
KLIN-20/CBS/24V/ADR	132
KLIN-20/ST	37
KLIN-20/ST/ADR	87
KLIN-20/ST/WL	107
KLIN-22/CBS/24V/ADR	132
KLR-20	53
KLR-20/CBS	145
KLR-20/CBS/24V/ADR	133
KLR-20/ST	53
KLR-20/ST/ADR	91
KLR-20/ST/WL	111
KLR-22/CBS	145
KLR-30/CBS	145
LLB-26/180	59
LLB-26/180/ADR	93
LLB-26/90	59
LLB-26/90/ADR	93
LLB-26/90/WL	109
LLB-26/CBS	149
LLB-26/CBS/24V/ADR	135
LLB-29/180/WL	109
LLB-40/180	59
LLB-40/180/ADR	93
LLB-40/180/WL	109
LLB-40/90	59
LLB-40/90/ADR	93
LLB-40/90/WL	109
LLB-40/CBS	149
LLB-64/180	59
LLB-64/180/ADR	93
LLB-64/180/WL	109
LLB-64/90	59
LLB-64/90/ADR	93
LLB-64/90/WL	109
LLB-64/CBS	149
LMD-28S/g	43
LMD-34D/w	43
LMD-34S/g	43
LMD-44D/w	43
LMD-44S/g	43

Type	Page
MLD-28D/w	43
OLY-1004	33
OLY-1004/ADR HIGH LUMINOCITY	86
OLY-1004/CBS/230V	139
OLY-1004/CBS/230V/WP	139
OLY-1004/CBS/24VDC	121
OLY-1004/CBS/24VDC/WP	121
OLY-1004/LF/WP	33
OLY-1004/LT/WP	33
OLY-1004/SC/WP	33
OLY-1004/WL HIGH LUMINOCITY	105
OLY-1004/WP	33
OLY-1004/WP/ADR HIGH LUMINOCITY	86
OLY-1004/WP/WL HIGH LUMINOCITY	105
OLY-1024	33
OLY-1024/ADR HIGH LUMINOCITY	86
OLY-1024/CBS/230V	139
OLY-1024/CBS/230V/WP	139
OLY-1024/CBS/24VDC	121
OLY-1024/CBS/24VDC/WP	121
OLY-1024/WL HIGH LUMINOCITY	105
OLY-1024/WP	33
OLY-1024/WP/ADR HIGH LUMINOCITY	86
OLY-1024/WP/WL HIGH LUMINOCITY	105
OLY-500	33
OLY-500/WP	33
PLD-25/CBS	144
PLD-25/MiMH	49
PLD-25/NiMH/M/ADR	88
PLD-25/NiMH/M/WL	112
PLD-25/NST	49
PLD-25/SC	49
PSL1100	154
PSL1200	154
PSL2200	154
PSL2400	154
PSL3400	154
PTD1400X	71
PTD1400X3	71
PTD1700XP	71
PTD2700X	71
PTD2700X3	71
PTD2700XP	71
PTD2700XP3	71
SLD-28/CBS/DZ	147
SLD-28/CBS/DZ/24V DC	127
SLD-28/CBS/SP	147
SLD-28/CBS/SP/24V DC	127
SLD-28/DZ	55
SLD-28/DZ/M/ADR	89
SLD-28/DZ/M/WL	113
SLD-28/SP	55
SLD-28/SP/M/ADR	89
SLD-28/SP/M/WL	113
SLD-28/SP/M/WL	113
SLD-34/CBS/DZ	147
SLD-34/CBS/DZ	147
SLD-34/CBS/DZ/24V DV	127
SLD-34/CBS/SP	147
SLD-34/CBS/SP/24V DC	127
SLD-34/DZ	55
SLD-34/DZ/M/ADR	89
SLD-34/DZ/M/WL	113
SLD-34/SP	55
SLD-34/SP/M/ADR	89
SLD-34/SP/M/WL	113
SLD-34/SP/M/WL	113
SLD-44/CBS/DZ/24V DC	127
SLD-44/CBS/SP	147
SLD-44/CBS/SP/24V DC	127
SLD-44/DZ	55
SLD-44/DZ/M/ADR	89
SLD-44/DZ/M/WL	113
SLD-44/SP	55
SLD-44/SP/M/ADR	89
SLD-44/SP/M/WL	113

# INDEX LUMINAIRES

Type	Page
ZLD-28/24V/ADR/EM	133
ZLD-28/CBS/24V DC/EM	126
ZLD-28/CBS/EM	144
ZLD-28/EM	45
ZLD-28/EM/ADR	88
ZLD-34/24V/ADR/EM	133
ZLD-34/CBS/24V DC/EM	126
ZLD-34/CBS/EM	144
ZLD-34/EM	45
ZLD-34/EM/ADR	88
ZLD-44/CBS/24V DC/EM	126
ZLD-44/CBS/EM	144
ZLD-44/EM	45
ZLD-44/EM/ADR	88





## RMA REQUEST PROCEDURE

Please read Section 1 and 2, the procedure for returning warranty and non-warranty products and the investigation fee are explained here. Following this RMA procedure will lead to faster repair of any equipment sent back to us.

**Please fully complete Section 3 and return to rma@olympia-electronics.gr**

Once the document has been received an RMA number can be issued.

### NOTE

The RMA will not be issued until Section 3 of this form is completed and returned. Section 3 of this form is required for both Warranty and Non-Warranty products. Returned products are not received without the RMA form.

### Section 1 - Warranty products

**Warranty products will be handled under the standard Olympia Electronics export terms and conditions of your agreement.**

**1.1 Return process for Warranty products.**  
All products that do not face a malfunction, will be returned to buyer, with their next shipment and the transportation cost will be on their account.

**1.2 Return process for Non-Warranty products.**  
Products that have exceeded their warranty period are not to be send to the company. In case they are send they are not going to be investigated nor returned to sender, they are going to be recycled.

### Section 2 - Investigation fee

**Olympia Electronics reserves the right within the RMA to charge an investigation fee. This fee covers investigation time and resource needed to identify any problems.**

### Section 3 RMA Form Request form for RMA number

### Section 4 - Credit Note process

**All Credit Notes will be issued for all the returned products upon their arrival at the Customs Office in GREECE. In case the returned products are not covered by Warranty, or the malfunction is buyer's (or installer's) responsibility, a relevant Debit Note will be issued.**

#### Shipping instructions:

All goods should be shipped direct to our premises:  
Olympia Electronics SA  
72o Km ONR Thessaloniki- Katerini  
Eginio - Pieria – Greece, P.O. 60300  
Telephone : +302353051200  
FAX: +302353051486  
E-mail : rma@olympia-electronics.gr

<b>Date</b> _____	<b>Customer Return Address</b>
<b>Customer Name</b> _____	_____
<b>Customer Contact Details</b> _____	_____
<b>Tel:</b> _____ <b>email:</b> _____	_____

<b>Warranty (Yes / No)</b> _____	<b>Investigation Fee Accepted (Yes / No)</b> _____	<b>Purchase Order number</b> _____
----------------------------------	--	------------------------------------

Line	Product	Article No	Production date (LOT no.)	Fault Description
1				
2				
3				
4				
5				



# EXPORT TERMS OF SALES

*The following conditions shall apply to any estimates, offers or acknowledged orders prepared in connection with any sales made outside Greek Territory by Olympia Electronics S.A.*

## 1. GENERAL CONDITIONS

By ordering goods, the buyer simultaneously proceeds to the acceptance of the export sales terms herein contained, regardless of any conditions, which may appear on the buyer's documents and subject to any special conditions accepted in writing.

## 2. PURCHASE ORDERS

The orders should be sent to Olympia Electronics in writing via e-mail or fax. In case that an order is lower than the amount of EURO 1500,00 then the buyer is charged EURO 75,00 fixed custom expenses cost. Moreover, for orders below the amount of EURO 300,00, the customer is charged EURO 50,00 administrative cost.

## 3. PURCHASE ORDER CANCELLATION

Olympia Electronics reserves the right to cancel an order in case that information is given by a data bank that the customer faces serious financial problems.

## Δ. DISPATCH OF AN ORDER

The delivery terms vary by case and depend on the agreement between Olympia Electronics and the buyer. The terms in force are indicated on the invoice.

## 4. PRICES

Valid prices are the ones that are mentioned in the official export price list of Olympia Electronics. Olympia Electronics reserves the right to make any modification.

## 5. TERMS OF PAYMENT

Terms of payment are specified on the invoice. In case that the buyer does not apply the specified terms of payment, Olympia Electronics reserves the right to issue an extra invoice charging customer the legal expenses for a period equal to the delay of the outstanding payment.

## 6. SAMPLES

Each potential buyer has the right to receive free of charge samples with value not exceeding EURO 50,00. The transportation cost of the samples is charged to the potential buyer.

## 7. LIMITED RESPONSIBILITY

Olympia Electronics is not responsible in case of mistreatment or bad operating conditions of goods by the buyer. Therefore the buyer cannot take any action against Olympia Electronics.

## 8. WARRANTY

Olympia Electronics guarantees the quality, condition and operation of the goods. The period of warranty is specified in the official catalogue of Olympia Electronics and also in the technical leaflet, which accompanies each product. This warranty ceases to exist if the buyer does not follow the technical instructions included in official documents given by Olympia Electronics or if the buyer modifies the goods provided or has any repairs or re-setting done by a third party, unless Olympia Electronics has fully agreed to them in writing. The defected goods can be returned only after a written confirmation by Olympia Electronics. Olympia Electronics reserves the right to repair or to replace the returned goods and to or not charge the buyer depending on the reason of defection. Olympia Electronics reserves the right to charge or not the buyer the transportation cost.

## 9. LEGAL DISPUTES

In case of disputes arising from the interpretation or the performance of the contract agreed upon, Thessaloniki Greek court will be the only competent court.

11. INSURANCE  
In case of any damage during delivery, the client must not sign for the collection of the goods so as Olympia Electronics to be able to claim this damage from the insurance company. Otherwise Olympia Electronics is not responsible for the damage.

\*All prices are NET F.C.A. THESSALONIKI.